

Compact Guide Cylinder (Basic type)

New

ø12, ø16, ø20, ø25, ø32, ø40, ø50, ø63, ø80, ø100

Up to
17%
Weight
reduced!

Weight reduced by up to 17% with
a shorter guide rod and thinner plate



Guide rod shortened
for MGPM40-25 stroke

Max. **22**mm

Space required between the
bottom of the cylinder body and
your equipment is reduced.

Space saving

Round type and magnetic field resistant
auto switches can be mounted directly
without spacer.

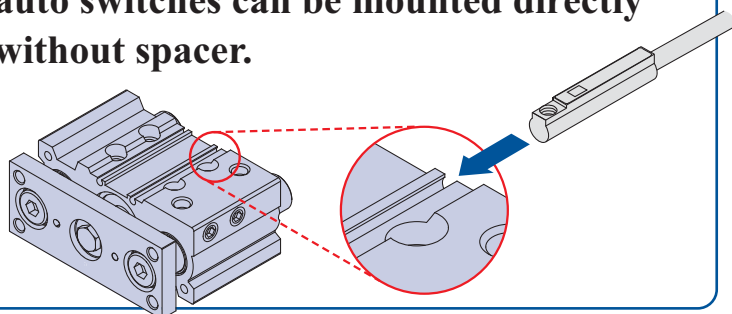

3 types of bearing can be selected.

- Slide bearing
Series MGPM
- Ball bushing
Series MGPL
- High precision ball bushing
Series MGPA

Series **MGP**

Compact Guide Cylinder (Basic type)

3 types of bearing can be selected.

Slide bearing Series MGPM

Suitable for lateral load applications such as a stopper where shock is applied

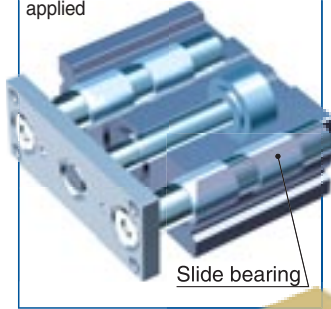

Slide bearing

Ball bushing Series MGPL

Smooth operation suitable for pusher and lifter

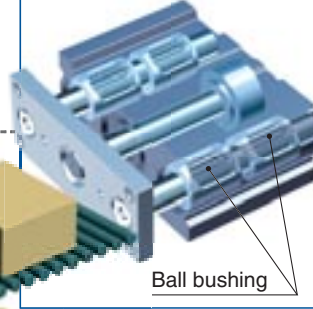

Ball bushing

High precision ball bushing Series MGPA

Suitable for minimizing plate displacement

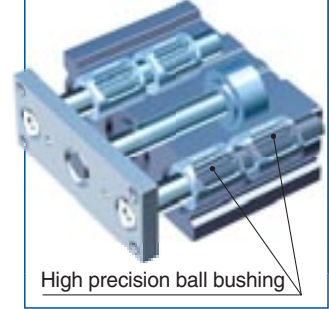

High precision ball bushing

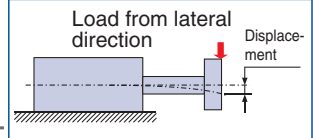
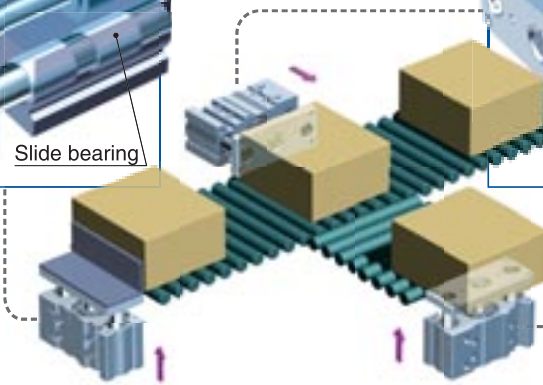

Weight reduced

Bore size	Reduction rate (%)	Weight lbs (kg)
ø12	11	0.55 (0.25)
ø16	3	0.82 (0.37)
ø20	12	1.30 (0.59)
ø25	12	3.61 (0.84)
ø32	17	3.10 (1.41)
ø40	16	3.61 (1.64)
ø50	17	6.15 (2.79)
ø63	17	7.67 (3.48)
ø80	17	11.9 (5.41)
ø100	13	20.1 (9.12)

* Compared with slide bearing type, ø12 to ø25-20 stroke
* Compared with slide bearing type, ø32 to ø100-25 stroke

Guide rod shortened

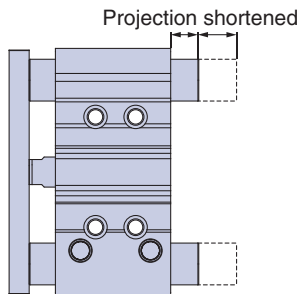

Bore size	Guide rod (mm)	
	Shortened by	New dimension
ø32	22	15.5
ø40	22	9
ø50	18	16.5
ø63	18	11.5
ø80	10.5	8
ø100	10.5	10.5

* Compared with slide bearing type, 25 stroke (ø32 to ø100)
(No projection for ø12 to ø25-25 stroke)

Performance, strength (rigidity), and mounting dimensions are equivalent to the conventional MGP series.

Small auto switches or magnetic field resistant auto switches can be mounted on 2 surfaces.

- D-M9□
- D-A9□
- D-P3DW

* The D-Y7 and D-Z7 auto switches are not mountable.

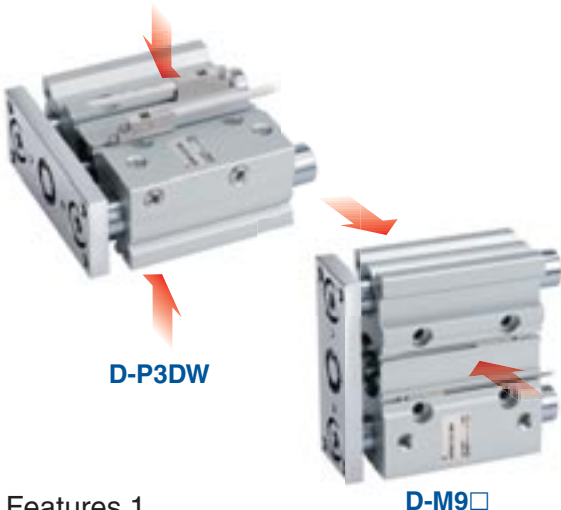

Features 1

4 types of mounting are possible.

Easy positioning
Knock pin holes provided on each mounting surface

1. Top mounting

2. Side mounting

4. Bottom mounting

3. T-slot side mounting

Easy adjustment of workpiece and cylinder mounting













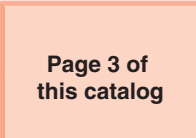

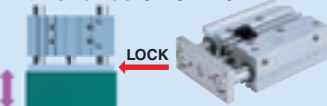



Piping is possible from 2 directions.

1. Top ported

2. Side ported



Compact Guide Cylinders, Series Variations

Series	Bearing	Bore size											Page			
		6	10	12	16	20	25	32	40	50	63	80		100		
Basic type/MGP  																
With air cushion/MGP-A 	Slide bearing															 P.289
	Ball bushing															
	High precision ball bushing															
With end lock/MGP-H/R 																 P.307
Clean series/12/13-MGP 	Ball bushing															 P.283
Water-resistant/MGP R/V 															 P.283	
Heavy duty guide rod/MGPS 	Slide bearing														 P.319	
Miniature Guide Rod Cylinder/MGJ 															 P.255	
Compact Guide Cylinder with Lock/MLGP 	Slide bearing														 P.881	
	Ball bushing															
Hygienic Design Cylinder/HYG 	Slide bearing														 P.873	

Series MGP (Basic type), Stroke Variations

Bearing type	Bore size (mm)	Stroke (mm)															
		10	20	25	30	40	50	75	100	125	150	175	200	250	300	350	400
MGPM Slide bearing	12																
	16																
	20																
MGPL Ball bushing	25																
	32																
	40																
MGPA High precision ball bushing	50																
	63																
	80																
	100																



Series MGP Specific Product Precautions 1

Be sure to read before handling. Refer to back cover for Safety Instructions, "Handling Precautions for SMC Products" (M-E03-3) and the Operation Manual for Actuator Precautions and Auto Switch Precautions. Please download it via our website.
<http://www.smcworld.com>

Mounting

Warning

1. Never place your hands or fingers between the plate and the body.

Be very careful to prevent your hands or fingers from getting caught in the gap between the cylinder body and the plate when air is applied.

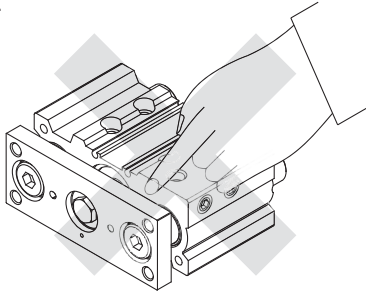

Caution

1. Use cylinders within the piston speed range.

An orifice is set for this cylinder, but the piston speed may exceed the operating range if the speed controller is not used. If the cylinder is used outside the operating speed range, it may cause damage to the cylinder and shorten the service life. Adjust the speed by installing the speed controller and use the cylinder within the limited range.

2. Pay attention to the operating speed when the product is mounted vertically.

When using the product in the vertical direction, if the load factor is large, the operating speed can be faster than the control speed of the speed controller (i.e. quick extension). In such cases, it is recommended to use a dual speed controller.

3. Do not scratch or gouge the sliding portion of the piston rod and the guide rod.

Damaged seals, etc. will result in leakage or malfunction.

4. Do not dent or scratch the mounting surface of a body and a plate.

The flatness of the mounting surface may not be maintained, which would cause an increase in sliding resistance.

5. Make sure that the cylinder mounting surface has a flatness of 0.05 mm or less.

Insufficient flatness of a workpiece or bracket mounted on the mounting surface or plate of the cylinder and other parts can cause defective operation and an increase in the sliding resistance.

Mounting

Caution

6. Bottom of cylinder

The guide rods protrude from the bottom of the cylinder at the end of the retracting stroke, and therefore, in cases where the cylinder is to be bottom mounted, it is necessary to provide bypass ports in the mounting surface for the guide rods, as well as holes for the hexagon socket head cap screws which are used for mounting.

Moreover, in applications where impact occurs from a stopper, etc., the mounting screws should be inserted to a depth of 2d or more.

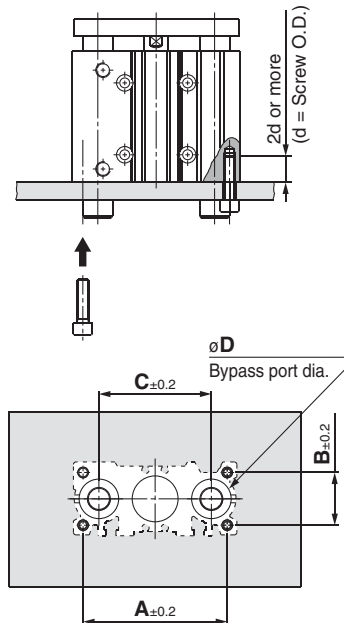

Bore size (mm)	A (mm)	B (mm)	C (mm)	D (mm)		Hexagon socket head cap screw
				MGPM	MGPL/A	
12	50	18	41	10	8	M4 x 0.7
16	56	22	46	12	10	M5 x 0.8
20	72	24	54	14	12	M5 x 0.8
25	82	30	64	18	15	M6 x 1.0
32	98	34	78	22	18	M8 x 1.25
40	106	40	86	22	18	M8 x 1.25
50	130	46	110	27	22	M10 x 1.5
63	142	58	124	27	22	M10 x 1.5
80	180	54	156	33	28	M12 x 1.75
100	210	62	188	39	33	M14 x 2.0



Series MGP

Specific Product Precautions 2

Be sure to read before handling. Refer to back cover for Safety Instructions, "Handling Precautions for SMC Products" (M-E03-3) and the Operation Manual for Actuator Precautions and Auto Switch Precautions. Please download it via our website. <http://www.smcworld.com>

Piping

Caution

Depending on the operating conditions, piping port positions can be changed by using a plug.

1. M5

After tightening by hand, tighten additional 1/6 to 1/4 rotation with a tightening tool.

2. Tapered thread for Rc port (MGP) and NPT port (MGP□□TN)

Use the correct tightening torques listed below.

Before tightening the plug, wrap pipe tape around it. Also, with regard to the sunk dimension of a plug (dimension "a" in the drawing), use the stipulated figures as a guide and confirm the air leakage before operation.

* If tightening plugs on the top mounting port with more than the proper tightening torque, plugs will be screwed much deeply and air passage will be squeezed. Consequently, the cylinder speed will be restricted.

Connection thread (plug) size	Proper tightening torque (N·m)	a dimension
1/8	7 to 9	0.5 mm or less
1/4	12 to 14	1 mm or less
3/8	22 to 24	1 mm or less

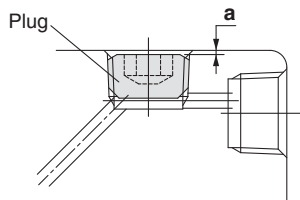

3. Parallel pipe thread for G port (MGP□□TF)

Screw in the plug to the surface of the body (dimension "a" in the drawing) by checking visually instead of using the tightening torque shown in the table.

Allowable Kinetic Energy

Caution

Load mass and a maximum speed must be within the ranges shown in the graphs below.

MGP with rubber bumper

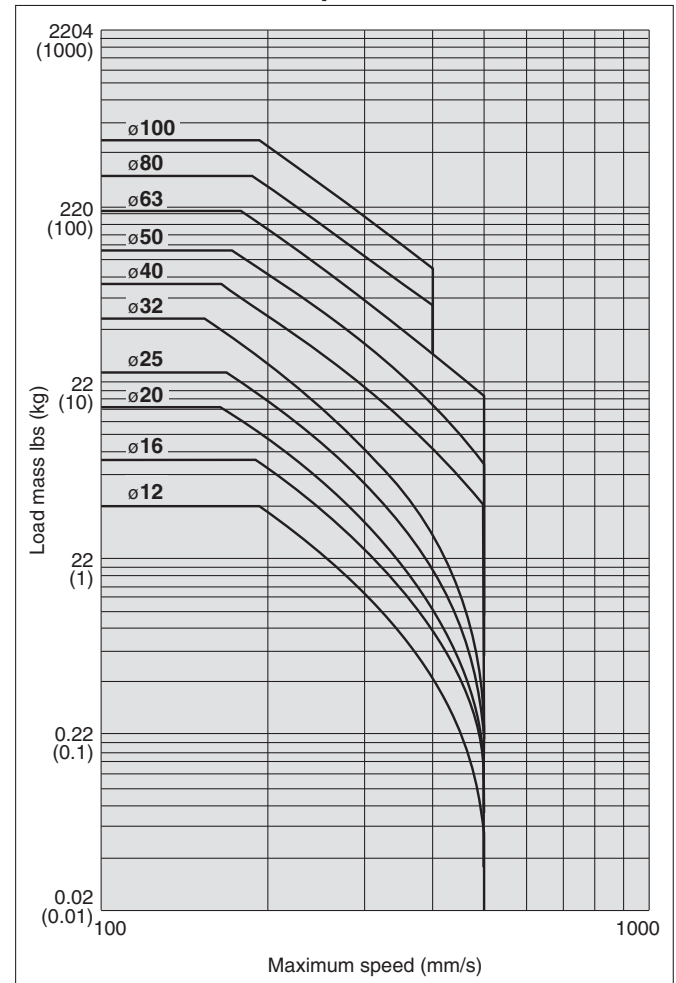

(1Kg = 2.2lbs)

Compact Guide Cylinder

Series MGP

ø12, ø16, ø20, ø25, ø32, ø40, ø50, ø63, ø80, ø100

How to Order

Compact Guide Cylinder **MGP M 25** **30 Z** **M9BW**

Compact Guide Cylinder

Bearing type

M	Slide bearing
L	Ball bushing
A	High precision ball bushing

Bore size

12	12 mm	40	40 mm
16	16 mm	50	50 mm
20	20 mm	63	63 mm
25	25 mm	80	80 mm
32	32 mm	100	100 mm

Port thread type

Nil	M5 x 0.8
TN	NPT
TF	G

* For bore sizes with ø12 and ø16, only M5 x 0.8 is available.

Number of auto switches

Nil	2 pcs.
S	1 pc.
n	n pcs.

Auto switch

Nil	Without auto switch (Built-in magnet)
-----	---------------------------------------

* For applicable auto switch model, refer to the table below.

Cylinder stroke (mm)
Refer to "Standard Strokes" on page 4.

Applicable Auto Switches/Refer to pages 1719 to 1827 in Best Pneumatics No. 3 for further information on auto switches.

Type	Special function	Electrical entry	Indicator light	Wiring (Output)	Load voltage		Auto switch model		Lead wire length (m)				Pre-wired connector	Applicable load			
					DC	AC	Perpendicular	In-line	0.5 (Nil)	1 (M)	3 (L)	5 (Z)					
Solid state auto switch	—	Grommet	Yes	3-wire (NPN)	5 V, 12 V	—	—	M9NV	M9N	●	●	●	○	○	IC circuit	Relay, PLC	
				3-wire (PNP)				M9PV	M9P	●	●	●	○	○			
				2-wire	M9BV			M9B	●	●	●	○	○				
				3-wire (NPN)	M9NVV			M9NW	●	●	●	○	○				
	3-wire (PNP)			M9PVV	M9PW			●	●	●	○	○	IC circuit				
	2-wire			M9BWW	M9BW			●	●	●	○	○					
	Water-resistant (2-color display)			3-wire (NPN)	M9NAV***			M9NA***	○	○	●	○	○	IC circuit			
				3-wire (PNP)	M9PAV***			M9PA***	○	○	●	○	○				
	Magnetic field resistant (2-color display)			2-wire	M9BAV***			M9BA***	○	○	●	○	○	—			
				2-wire (Non-polar)	—			P3DW**	●	—	●	●	○				
Feed auto switch	—	Grommet	No	3-wire (NPN equivalent)	—	5 V	—	A96V	A96	●	—	●	—	—	IC circuit	—	
				2-wire	24 V	12 V	100 V	A93V	A93	●	—	●	●	—	—	—	Relay, PLC
							100 V or less	A90V	A90	●	—	●	—	—	—	IC circuit	

***Water-resistant type auto switch can be mounted to the models with the above mentioned part numbers, but this does not guarantee the water resistance of the cylinder. A water-resistant type cylinder is recommended for use in an environment which requires water resistance. However, please contact SMC for water-resistant products of ø12 and ø16.

* Lead wire length symbols: 0.5 m..... Nil (Example) M9NW
 1 m..... M (Example) M9NWM
 3 m..... L (Example) M9NWL
 5 m..... Z (Example) M9NWX

* Solid state auto switches marked with "○" are produced upon receipt of order.
 ** Bore sizes ø25 to ø100 are available for the D-P3DW.

* Since there are other applicable auto switches than listed, refer to page 22 for details.
 * For details about auto switches with pre-wired connector, refer to pages 1784 and 1785 in Best Pneumatics No. 3.
 For D-P3DW□, refer to the catalog CAT. ES20-201.
 * Auto switches are shipped together, (but not assembled).

Specifications



Bore size	ø12	ø16	ø20	ø25	ø32	ø40	ø50	ø63	ø80	ø100
Action	Double acting									
Fluid	Air									
Proof pressure	218psi (1.5 MPa)									
Maximum operating pressure	145psi (1.0 MPa)									
Minimum operating pressure	17psi (0.12 MPa)		14.5psi (0.1 MPa)							
Ambient and fluid temperature	14 to 140°F (-10 to 60°C) (No freezing)									
Piston speed ^{Note)}	50 to 500 mm/s								50 to 400 mm/s	
Cushion	Rubber bumper on both ends									
Lubrication	Not required (Non-lube)									
Stroke length tolerance	$^{+1.5}_0$ mm									

Note) Maximum speed with no load.

Make a model selection, considering a load according to the graph on pages 8 to 14.

Standard Strokes

Bore size (mm)	Standard stroke (mm)
12, 16	10, 20, 30, 40, 50, 75, 100, 125, 150, 175, 200, 250
20, 25	20, 30, 40, 50, 75, 100, 125, 150, 175, 200, 250, 300, 350, 400
32 to 100	25, 50, 75, 100, 125, 150, 175, 200, 250, 300, 350, 400

Manufacture of Intermediate Strokes

Refer to pages 21 to 23 for cylinders with auto switches.

- Auto switch proper mounting position (detection at stroke end) and mounting height
- Minimum stroke for auto switch mounting
- Operating range
- Auto switch mounting brackets/Part no.

Description	Spacer installation Spacers are installed in the standard stroke cylinder. • ø12 to ø32: Available by the 1 mm stroke interval. • ø40 to ø100: Available by the 5 mm stroke interval.	
Part no.	Refer to "How to Order" for the standard model numbers.	
Applicable stroke (mm)	ø12, ø16	1 to 249
	ø20 to ø32	1 to 399
	ø40 to ø100	5 to 395
Example	Part no.: MGPM20-39 A spacer 1 mm in width is installed in a MGPM20-40. C dimension is 77 mm.	

Theoretical Output

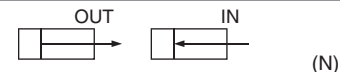

Bore size (mm)	Rod size (mm)	Operating direction	Piston area (mm ²)	Operating pressure psi (MPa)										
				29 (0.2)	44 (0.3)	58 (0.4)	73 (0.5)	87 (0.6)	102 (0.7)	116 (0.8)	131 (0.9)	145 (1.0)		
12	6	OUT	113	23	34	45	57	68	79	90	102	113		
		IN	85	17	25	34	42	51	59	68	76	85		
16	8	OUT	201	40	60	80	101	121	141	161	181	201		
		IN	151	30	45	60	75	90	106	121	136	151		
20	10	OUT	314	63	94	126	157	188	220	251	283	314		
		IN	236	47	71	94	118	141	165	188	212	236		
25	10	OUT	491	98	147	196	245	295	344	393	442	491		
		IN	412	82	124	165	206	247	289	330	371	412		
32	14	OUT	804	161	241	322	402	483	563	643	724	804		
		IN	650	130	195	260	325	390	455	520	585	650		
40	14	OUT	1257	251	377	503	628	754	880	1005	1131	1257		
		IN	1103	221	331	441	551	662	772	882	992	1103		
50	18	OUT	1963	393	589	785	982	1178	1374	1571	1767	1963		
		IN	1709	342	513	684	855	1025	1196	1367	1538	1709		
63	18	OUT	3117	623	935	1247	1559	1870	2182	2494	2806	3117		
		IN	2863	573	859	1145	1431	1718	2004	2290	2576	2863		
80	22	OUT	5027	1005	1508	2011	2513	3016	3519	4021	4524	5027		
		IN	4646	929	1394	1859	2323	2788	3252	3717	4182	4646		
100	26	OUT	7854	1571	2356	3142	3927	4712	5498	6283	7069	7854		
		IN	7323	1465	2197	2929	3662	4394	5126	5858	6591	7323		

Note) Theoretical output (N) = Pressure (MPa) x Piston area (mm²)

(1N = 0.22 lbf)

Series MGP

Weight

Slide Bearing: MGPM12 to 100

(kg)

Bore size (mm)	Standard stroke (mm)															
	10	20	25	30	40	50	75	100	125	150	175	200	250	300	350	400
12	0.22	0.25	—	0.29	0.33	0.36	0.46	0.55	0.66	0.75	0.84	0.93	1.11	—	—	—
16	0.32	0.37	—	0.42	0.46	0.51	0.66	0.78	0.94	1.06	1.18	1.31	1.55	—	—	—
20	—	0.59	—	0.67	0.74	0.82	1.06	1.24	1.43	1.61	1.80	1.99	2.42	2.79	3.16	3.53
25	—	0.84	—	0.94	1.04	1.14	1.50	1.75	2.00	2.25	2.50	2.75	3.35	3.85	4.34	4.84
32	—	—	1.41	—	—	1.77	2.22	2.57	2.93	3.29	3.65	4.00	4.90	5.61	6.33	7.04
40	—	—	1.64	—	—	2.04	2.52	2.92	3.32	3.71	4.11	4.50	5.47	6.26	7.06	7.85
50	—	—	2.79	—	—	3.38	4.13	4.71	5.30	5.89	6.47	7.06	8.55	9.73	10.9	12.1
63	—	—	3.48	—	—	4.15	4.99	5.67	6.34	7.02	7.69	8.37	10.0	11.4	12.7	14.1
80	—	—	5.41	—	—	6.26	7.41	8.26	9.10	9.95	10.8	11.6	13.9	15.6	17.3	19.0
100	—	—	9.12	—	—	10.3	12.0	13.2	14.4	15.6	16.9	18.1	21.2	23.6	26.1	28.5

Ball Bushing: MGPL12 to 100, High Precision Ball Bushing: MGPA12 to 100

(kg)

Bore size (mm)	Standard stroke (mm)															
	10	20	25	30	40	50	75	100	125	150	175	200	250	300	350	400
12	0.21	0.24	—	0.27	0.32	0.35	0.43	0.50	0.59	0.67	0.75	0.83	0.99	—	—	—
16	0.31	0.35	—	0.40	0.47	0.51	0.62	0.72	0.85	0.96	1.06	1.17	1.38	—	—	—
20	—	0.60	—	0.66	0.79	0.85	1.01	1.17	1.36	1.52	1.68	1.84	2.17	2.49	2.81	3.13
25	—	0.87	—	0.96	1.12	1.20	1.41	1.62	1.86	2.06	2.27	2.48	2.92	3.33	3.75	4.16
32	—	—	1.37	—	—	1.66	2.08	2.37	2.74	3.03	3.31	3.60	4.25	4.82	5.39	5.97
40	—	—	1.59	—	—	1.92	2.38	2.70	3.11	3.44	3.77	4.09	4.81	5.46	6.11	6.76
50	—	—	2.65	—	—	3.14	3.85	4.34	4.97	5.47	5.96	6.45	7.57	8.56	9.54	10.5
63	—	—	3.33	—	—	3.91	4.71	5.29	6.01	6.59	7.17	7.75	9.05	10.2	11.4	12.5
80	—	—	5.27	—	—	6.29	7.49	8.21	8.92	9.64	10.4	11.1	12.9	14.3	15.7	17.2
100	—	—	8.62	—	—	10.1	11.8	12.9	13.9	15.0	16.0	17.1	19.6	21.7	23.8	25.9

(1Kg = 2.2lbs)

Allowable Rotational Torque of Plate

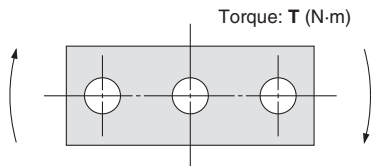

T (N-m)

Bore size (mm)	Bearing type	Stroke (mm)															
		10	20	25	30	40	50	75	100	125	150	175	200	250	300	350	400
12	MGPM	0.39	0.32	—	0.27	0.24	0.21	0.43	0.36	0.31	0.27	0.24	0.22	0.19	—	—	—
	MGPL/A	0.61	0.45	—	0.35	0.58	0.50	0.37	0.29	0.24	0.20	0.18	0.16	0.12	—	—	—
16	MGPM	0.69	0.58	—	0.49	0.43	0.38	0.69	0.58	0.50	0.44	0.40	0.36	0.30	—	—	—
	MGPL/A	0.99	0.74	—	0.59	0.99	0.86	0.65	0.52	0.43	0.37	0.32	0.28	0.23	—	—	—
20	MGPM	—	1.05	—	0.93	0.83	0.75	1.88	1.63	1.44	1.28	1.16	1.06	0.90	0.78	0.69	0.62
	MGPL/A	—	1.26	—	1.03	2.17	1.94	1.52	1.25	1.34	1.17	1.03	0.93	0.76	0.65	0.56	0.49
25	MGPM	—	1.76	—	1.55	1.38	1.25	2.96	2.57	2.26	2.02	1.83	1.67	1.42	1.24	1.09	0.98
	MGPL/A	—	2.11	—	1.75	3.37	3.02	2.38	1.97	2.05	1.78	1.58	1.41	1.16	0.98	0.85	0.74
32	MGPM	—	—	6.35	—	—	5.13	5.69	4.97	4.42	3.98	3.61	3.31	2.84	2.48	2.20	1.98
	MGPL/A	—	—	5.95	—	—	4.89	5.11	4.51	6.34	5.79	5.33	4.93	4.29	3.78	3.38	3.04
40	MGPM	—	—	7.00	—	—	5.66	6.27	5.48	4.87	4.38	3.98	3.65	3.13	2.74	2.43	2.19
	MGPL/A	—	—	6.55	—	—	5.39	5.62	4.96	6.98	6.38	5.87	5.43	4.72	4.16	3.71	3.35
50	MGPM	—	—	13.0	—	—	10.8	12.0	10.6	9.50	8.60	7.86	7.24	6.24	5.49	4.90	4.43
	MGPL/A	—	—	9.17	—	—	7.62	9.83	8.74	11.6	10.7	9.83	9.12	7.95	7.02	6.26	5.63
63	MGPM	—	—	14.7	—	—	12.1	13.5	11.9	10.7	9.69	8.86	8.16	7.04	6.19	5.52	4.99
	MGPL/A	—	—	10.2	—	—	8.48	11.0	9.74	13.0	11.9	11.0	10.2	8.84	7.80	6.94	6.24
80	MGPM	—	—	21.9	—	—	18.6	22.9	20.5	18.6	17.0	15.6	14.5	12.6	11.2	10.0	9.11
	MGPL/A	—	—	15.1	—	—	23.3	22.7	20.6	18.9	17.3	16.0	14.8	12.9	11.3	10.0	8.94
100	MGPM	—	—	38.8	—	—	33.5	37.5	33.8	30.9	28.4	26.2	24.4	21.4	19.1	17.2	15.7
	MGPL/A	—	—	27.1	—	—	30.6	37.9	34.6	31.8	29.3	27.2	25.3	22.1	19.5	17.3	15.5

(1N-m = 0.74 ft-lb)

Non-rotating Accuracy of Plate

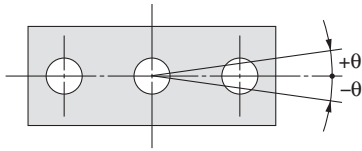

Non-rotating accuracy θ when retracted and when no load is applied should be not more than the values shown in the table.

Bore size (mm)	Non-rotating accuracy θ		
	MGPM	MGPL	MGPA
12	$\pm 0.07^\circ$	$\pm 0.05^\circ$	$\pm 0.01^\circ$
16			
20			
25	$\pm 0.06^\circ$	$\pm 0.04^\circ$	
32			
40	$\pm 0.05^\circ$	$\pm 0.03^\circ$	
50	$\pm 0.04^\circ$	$\pm 0.03^\circ$	
63			
80	$\pm 0.03^\circ$	$\pm 0.03^\circ$	
100			

High Precision Ball Bushing/MGPA

⚠ Caution

Positioning accuracy for pin hole on the plate

Dispersion of dimensions when machining each component will be accumulated in the plate pin hole positioning accuracy when mounting this cylinder. Values below are referred as a guide.

[Side mounting]

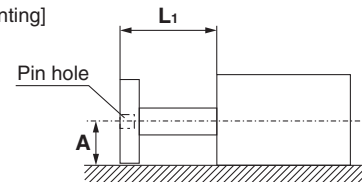

$$A = \text{Catalog dimension} \pm (0.1 + L_1 \times 0.0008) \text{ [mm]}$$

* : To be 0.15 for $\phi 80$, $\phi 100$

Note) Displacement by load and self-weight deflection by plate and guide rod are not included.

[Bottom mounting]

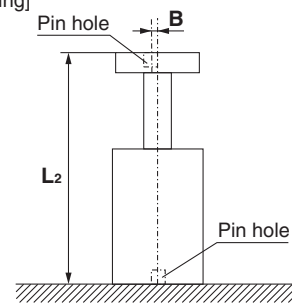

$$B = \pm (0.045 + L_2 \times 0.0016) \text{ [mm]}$$

Series MGP

High Precision Ball Bushing/MGPA Plate Displacement Amount (Reference Values)

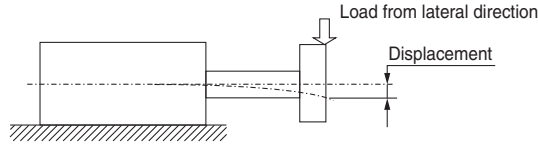

MGPA12

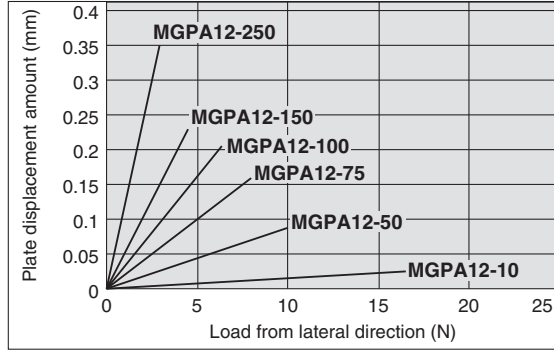

MGPA32/40

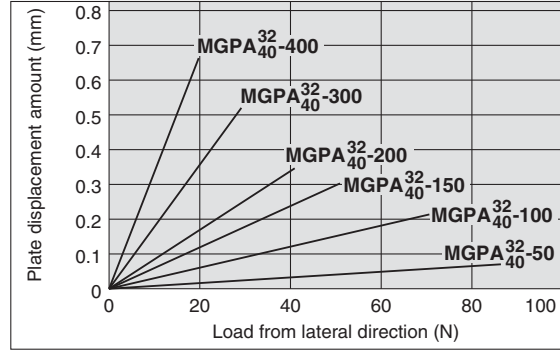

MGPA16

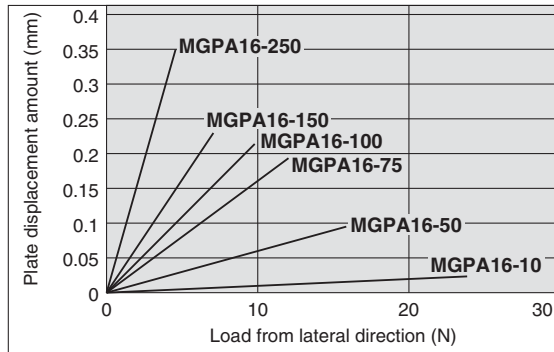

MGPA50/63

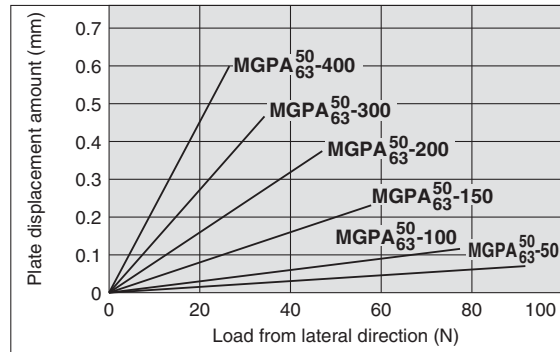

MGPA20

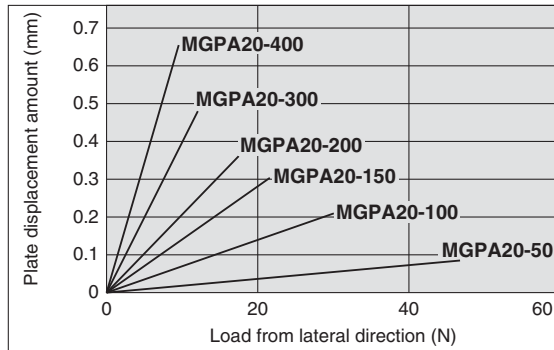

MGPA80

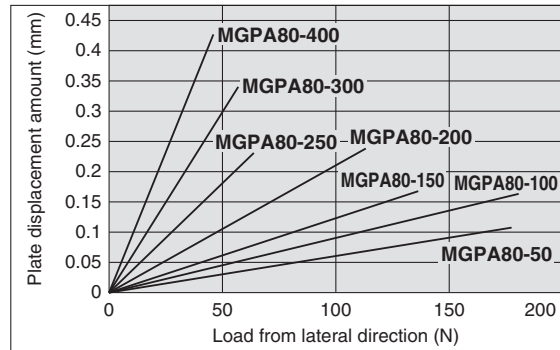

MGPA25

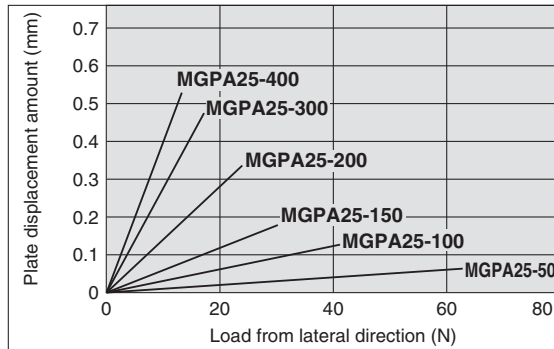

MGPA100

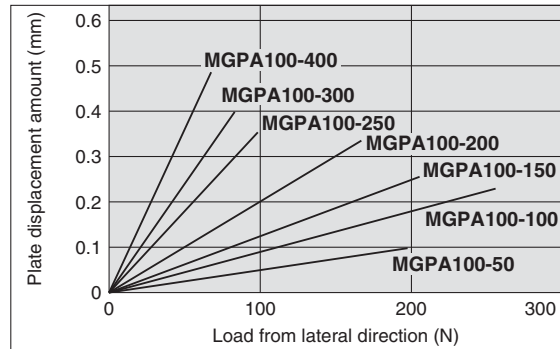

Note 1) The guide rod and self-weight for the plate are not included in the above displacement values.

Note 2) Allowable rotating torque, and operating range when used as a lifter, are the same as MGPL series.

Series MGP

Model Selection

Selection Conditions

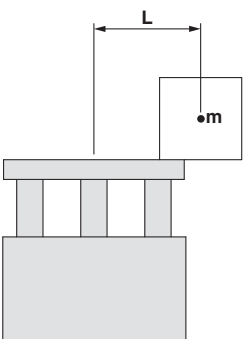
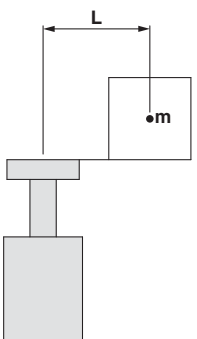
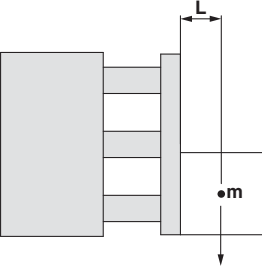
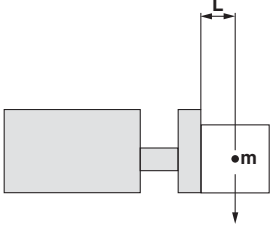
Mounting orientation	Vertical		Horizontal	
				
Maximum speed (mm/s)	200 or less	400	200 or less	400
Graph (Slide bearing type)	(1), (2)	(3), (4)	(13), (14)	(15), (16)
Graph (Ball bushing type)	(5) to (8)	(9) to (12)	(17), (18)	(19), (20)

Selection Example 1 (Vertical Mounting)

Selection conditions

Mounting: Vertical
 Bearing type: Ball bushing
 Stroke: 30 stroke
 Maximum speed: 200 mm/s
 Load mass: 6.6 lbs (3 kg)
 Eccentric distance: 90 mm

Find the point of intersection for the load mass of 3 kg and the eccentric distance of 90 mm on graph (5), based on vertical mounting, ball bushing, 30 stroke, and the speed of 200 mm/s.

→MGPL25-30 is selected.

(5) Less than 40 stroke, V = 200 mm/s or less

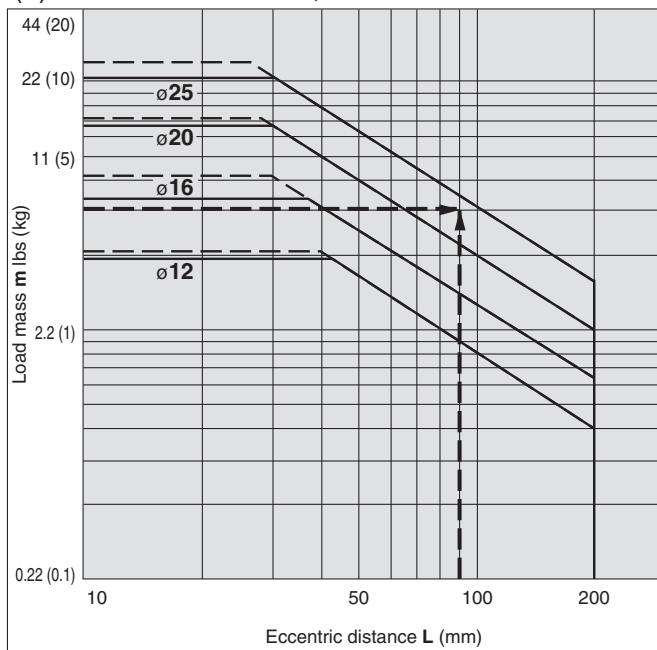

Selection Example 2 (Horizontal Mounting)

Selection conditions

Mounting: Horizontal
 Bearing type: Slide bearing
 Distance between plate and load center of gravity: 50 mm
 Maximum speed: 200 mm/s
 Load mass: 4.4 lbs (2 kg)
 Stroke: 30 stroke

Find the point of intersection for the load mass of 2 kg and 30 stroke on graph (13), based on horizontal mounting, slide bearing, the distance of 50 mm between the plate and load center of gravity, and the speed of 200 mm/s.

→MGPM20-30 is selected.

(13) L = 50 mm, V = 200 mm/s or less

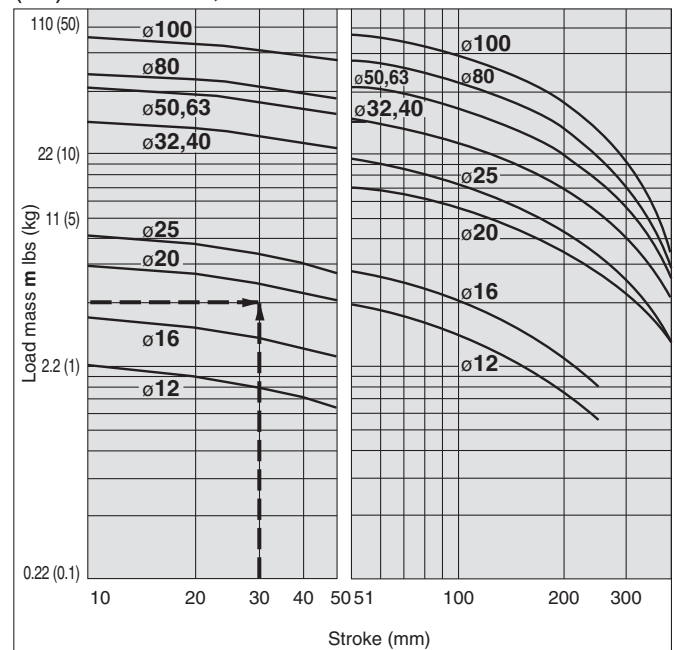

· When the maximum speed exceeds 200 mm/s, the allowable load mass is determined by multiplying the value shown in the graph at 400 mm/s by the coefficient listed in the table below.

Max. speed	Up to 300 mm/s	Up to 400 mm/s	Up to 500 mm/s
Coefficient	1.7	1	0.6

Series MGP

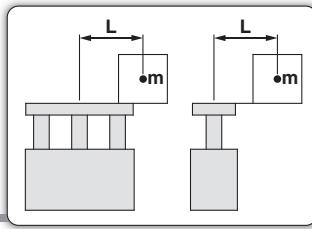

Vertical Mounting

Slide Bearing

— Operating pressure 58psi (0.4 MPa)
 - - - Operating pressure 73psi (0.5 MPa or more)

MGPM12 to 100

(1) 50 stroke or less, V = 200 mm/s or less

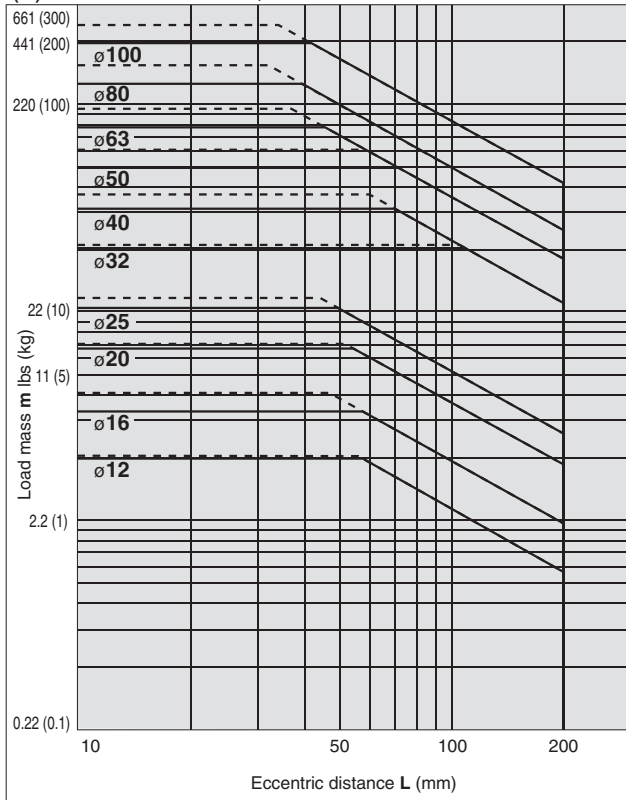

(2) Over 50 stroke, V = 200 mm/s or less

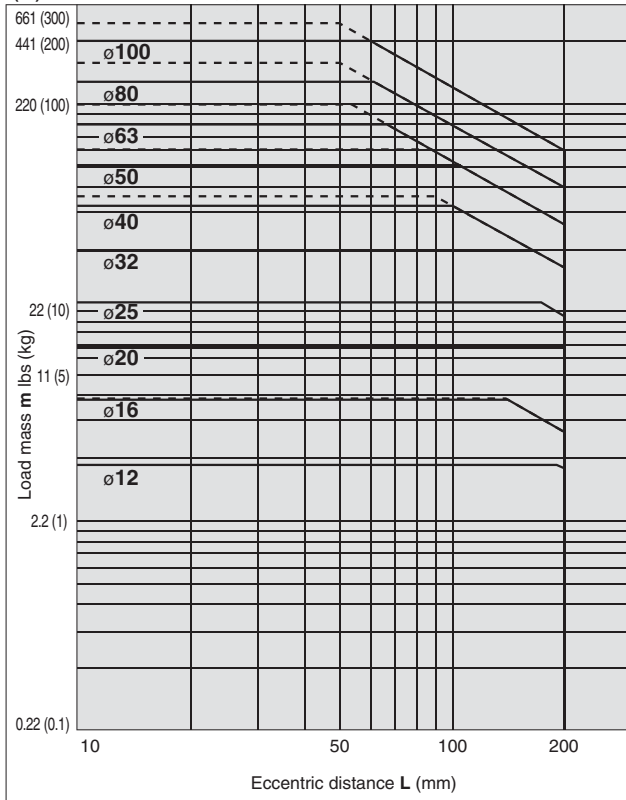

(3) 50 stroke or less, V = 400 mm/s

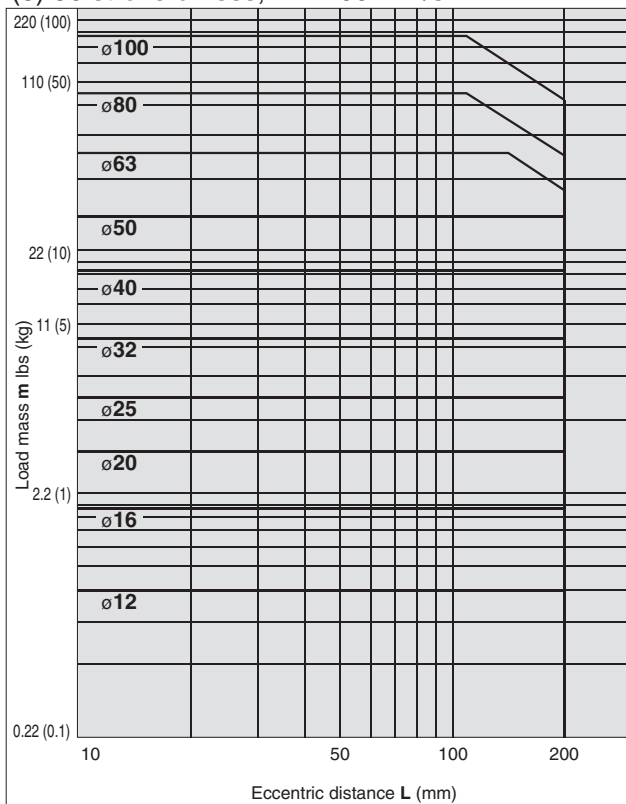

(4) Over 50 stroke, V = 400 mm/s

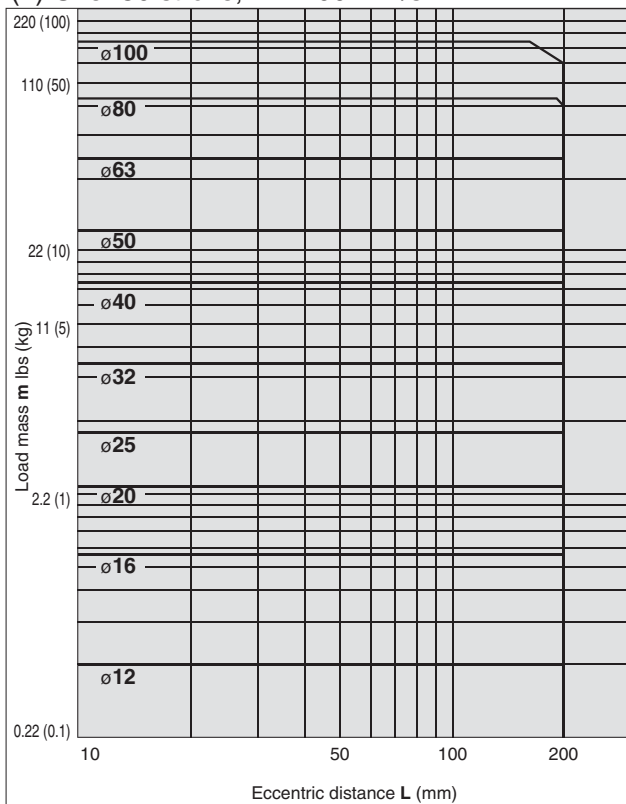

Vertical Mounting

Ball Bushing

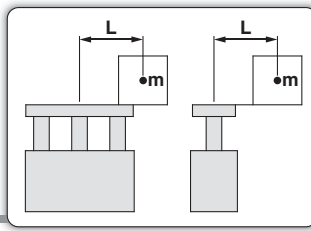

— Operating pressure 58psi (0.4 MPa)
 - - - Operating pressure 73psi (0.5 MPa) or more

MGPL12 to 25, MGPA12 to 25

(5) 30 stroke or less, V = 200 mm/s or less

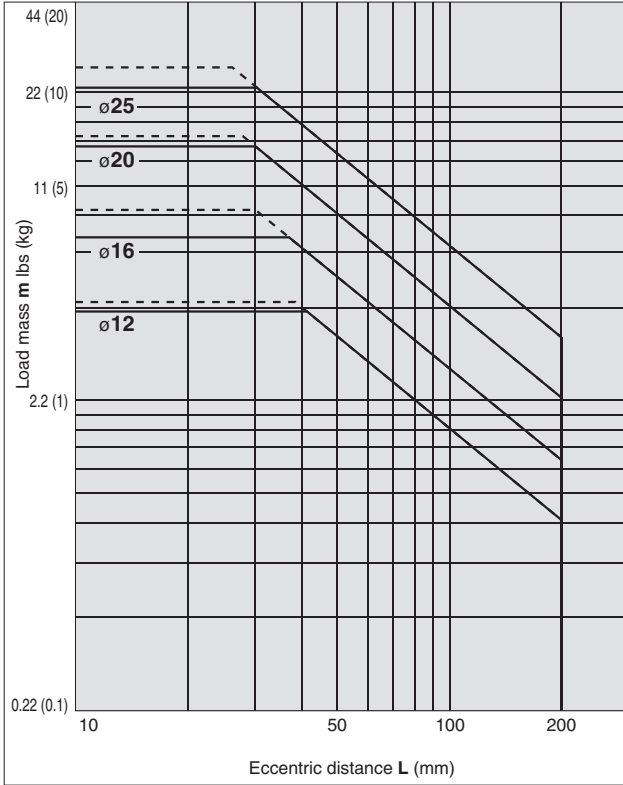

(6) Over 30 stroke, V = 200 mm/s or less

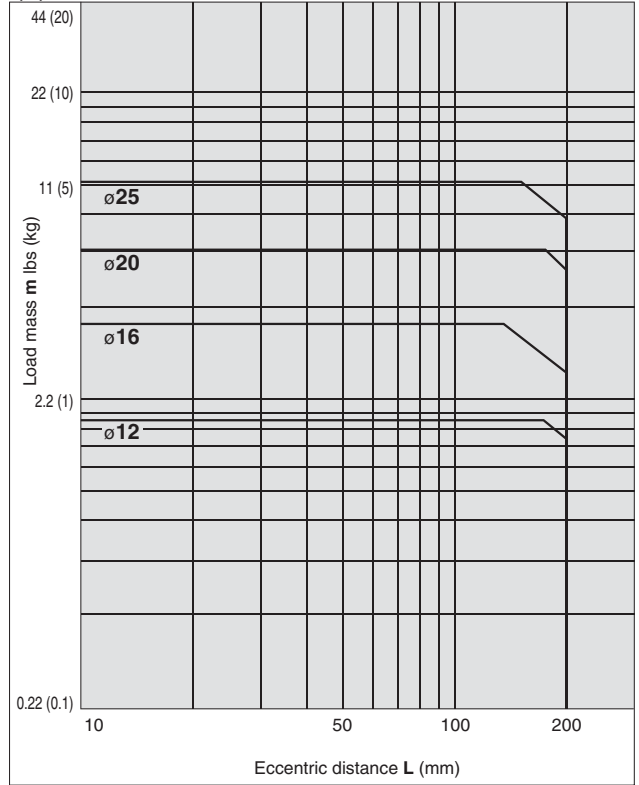

MGPL32 to 100, MGPA32 to 100

(7) 50 stroke or less, V = 200 mm/s or less

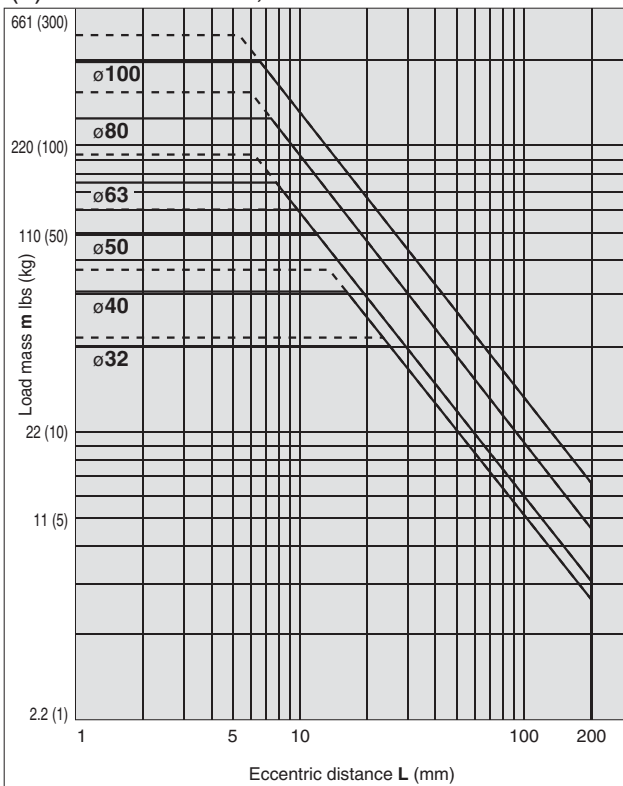

(8) Over 50 stroke, V = 200 mm/s or less

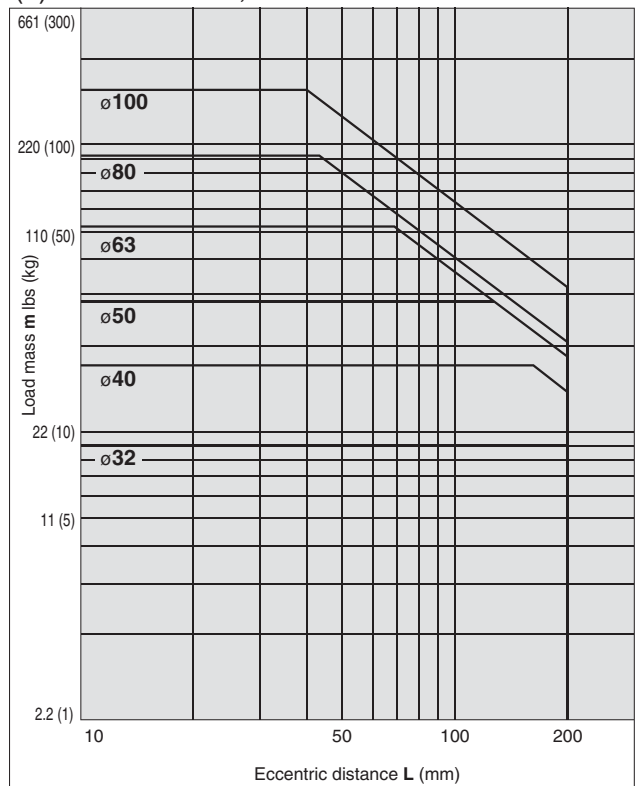

Series MGP

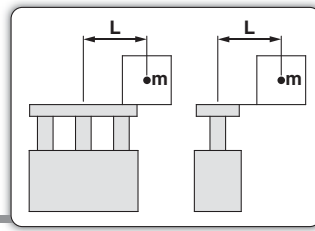

Vertical Mounting

Ball Bushing

Operating pressure 58psi (0.4 MPa)

MGPL12 to 25, MGPA12 to 25

(9) 30 stroke or less, V = 400 mm/s

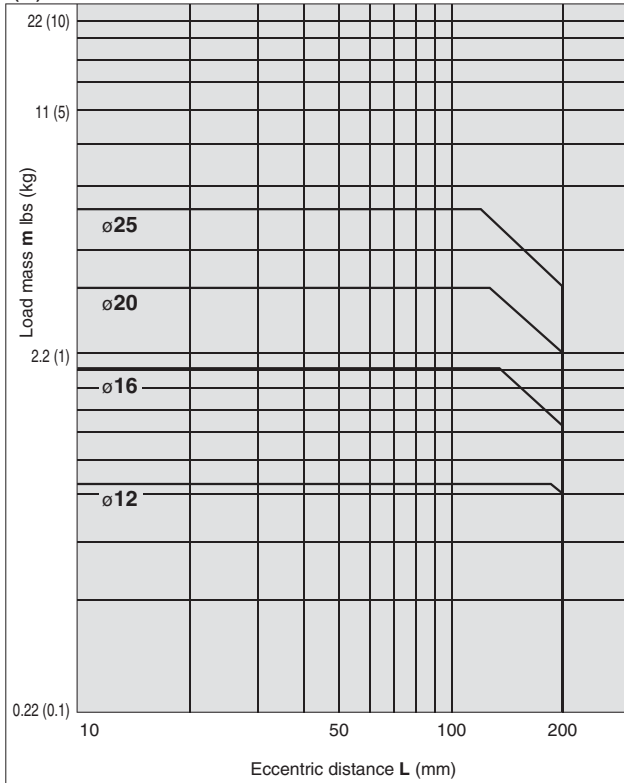

(10) Over 30 stroke, V = 400 mm/s

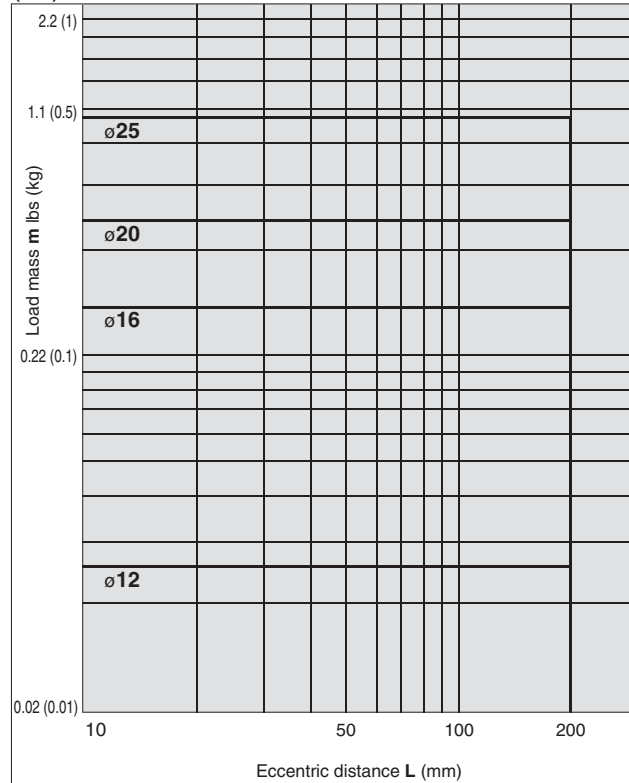

MGPL32 to 100, MGPA32 to 100

(11) 50 stroke or less, V = 400 mm/s

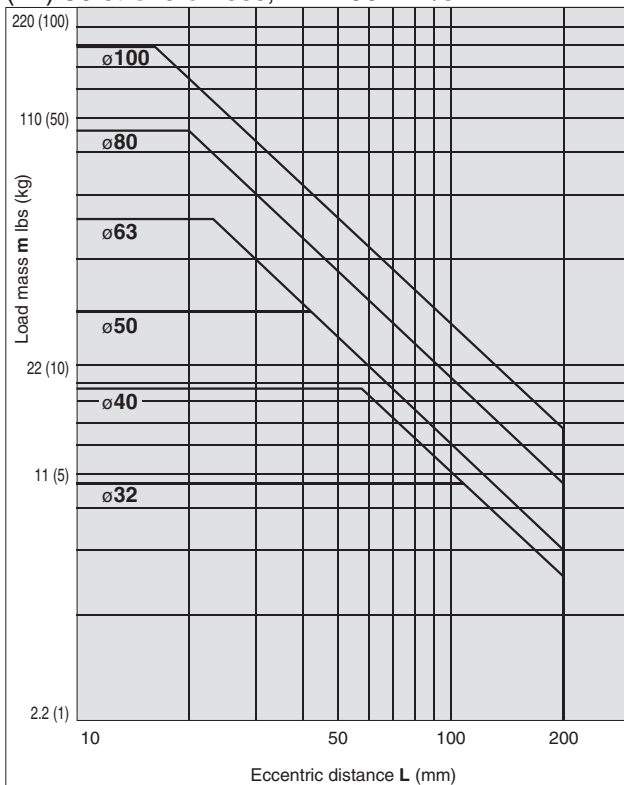

(12) Over 50 stroke, V = 400 mm/s

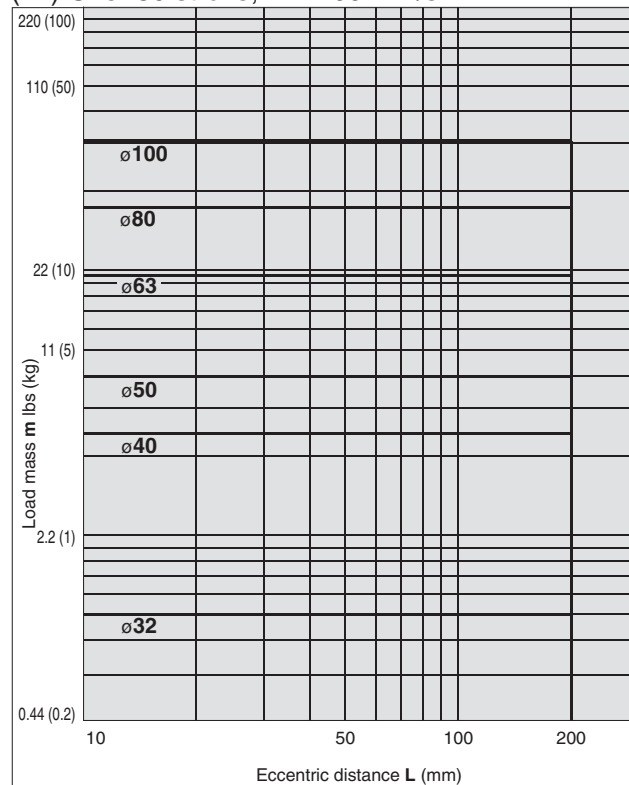

Horizontal Mounting

Slide Bearing

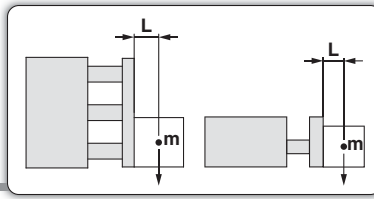

MGPM12 to 100

(13) L = 50 mm, V = 200 mm/s or less

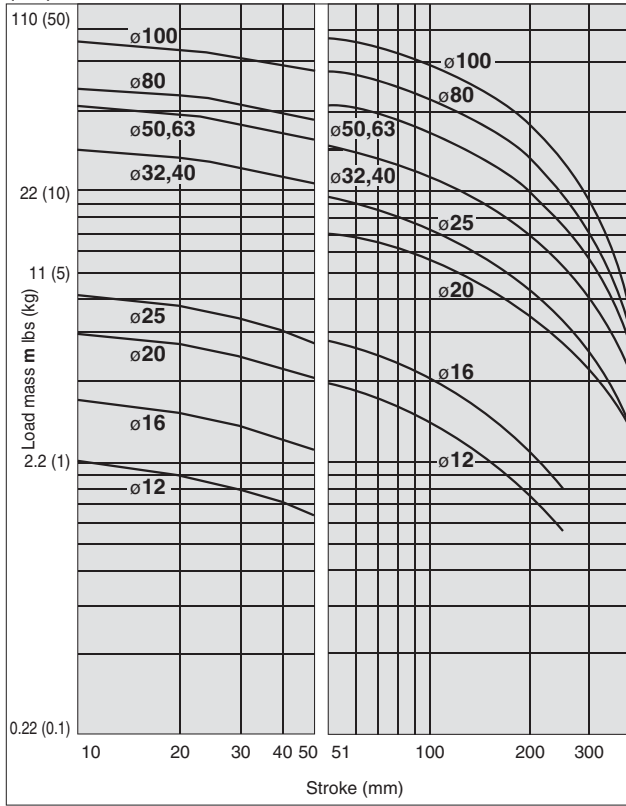

(14) L = 100 mm, V = 200 mm/s or less

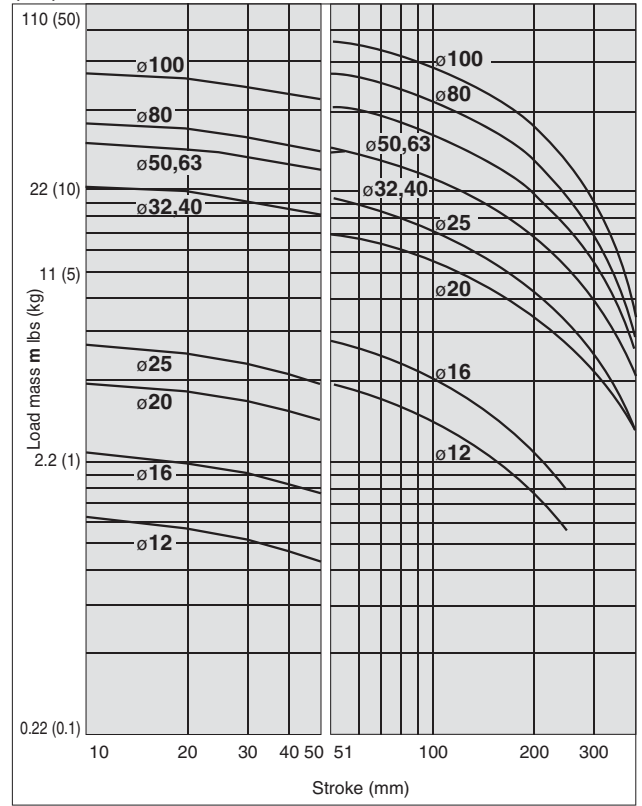

(15) L = 50 mm, V = 400 mm/s

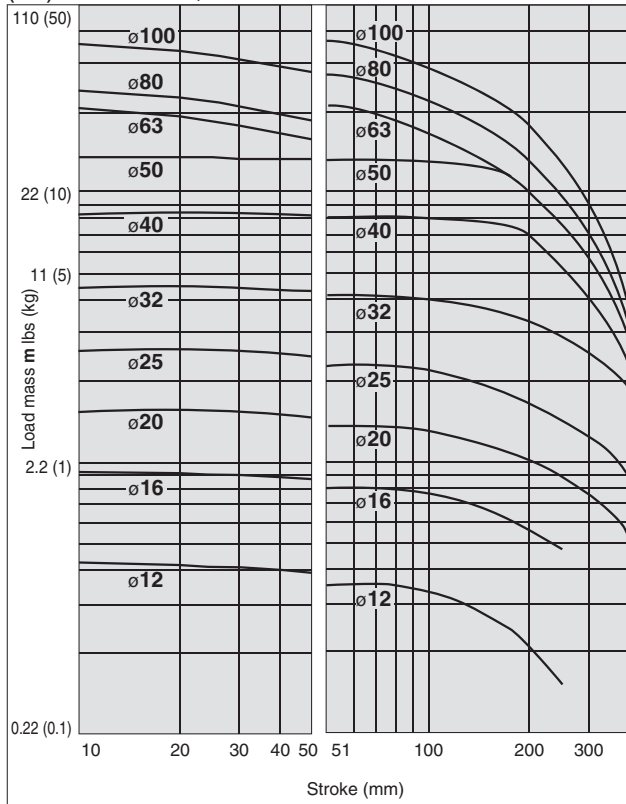

(16) L = 100 mm, V = 400 mm/s

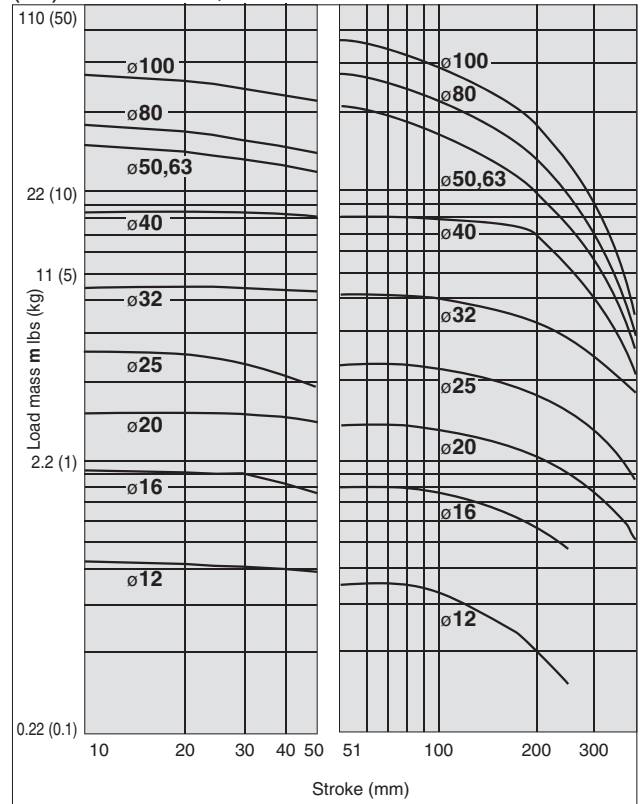

Series MGP

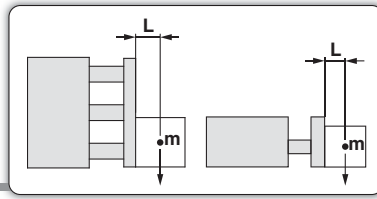

Horizontal Mounting

Ball Bushing

(17) L = 50 mm, V = 200 mm/s or less

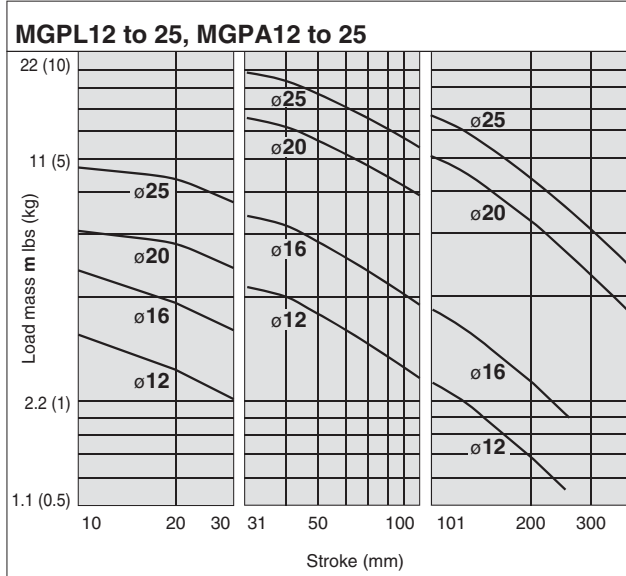

(18) L = 100 mm, V = 200 mm/s or less

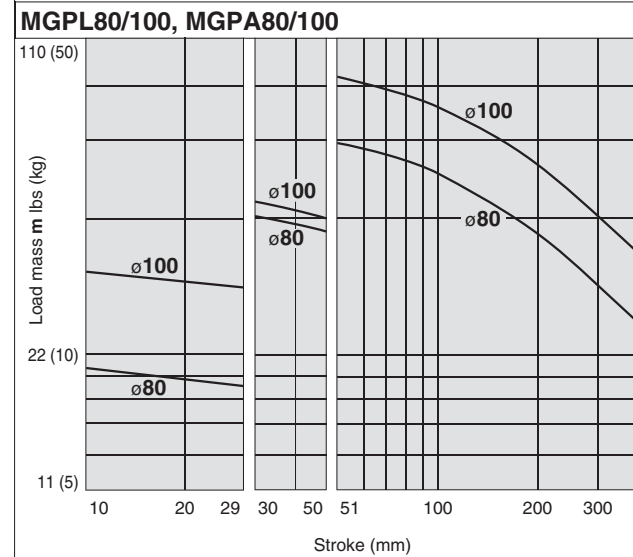
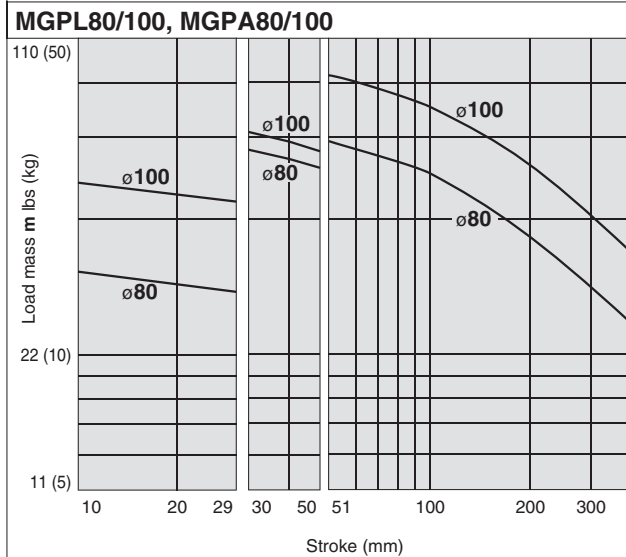
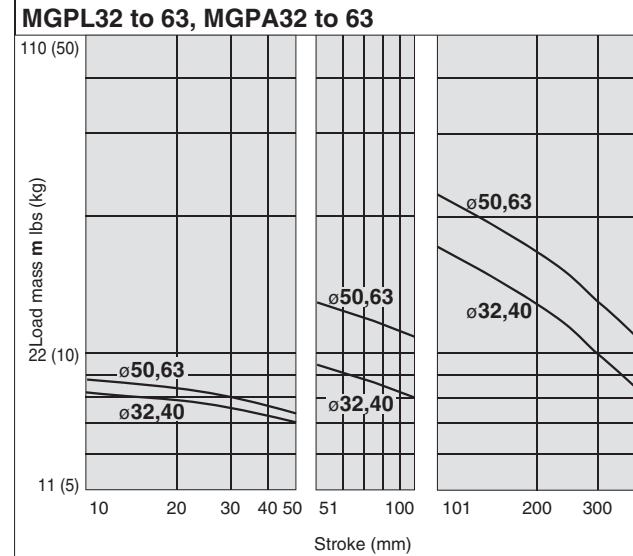
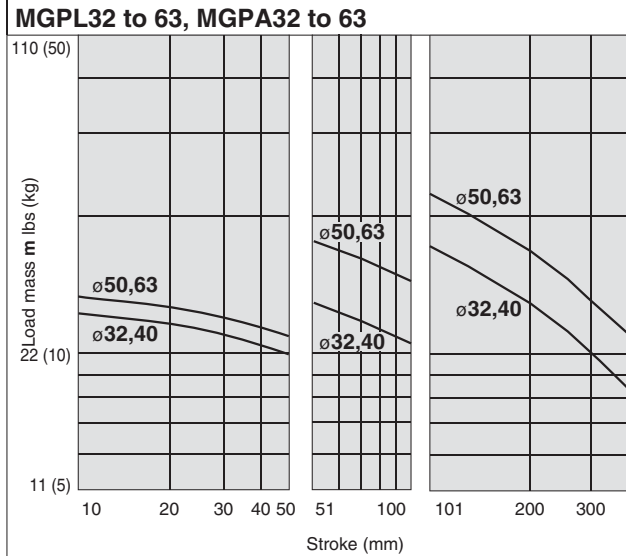
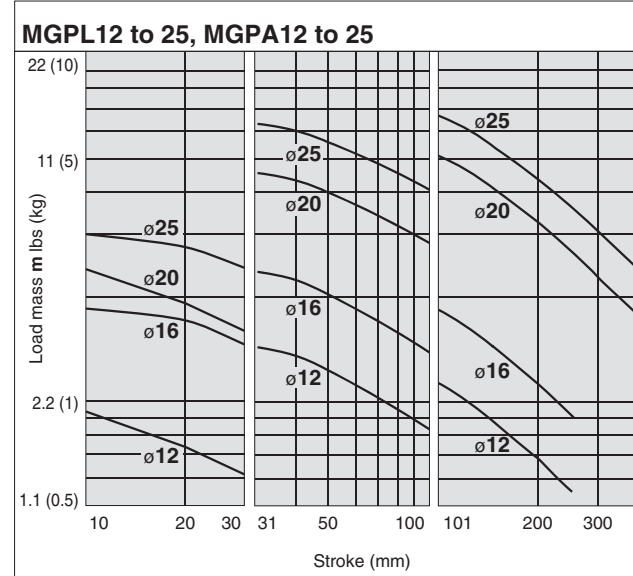

Horizontal Mounting

Ball Bushing

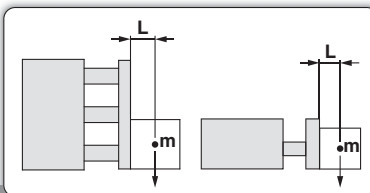

(19) L = 50 mm, V = 400 mm/s

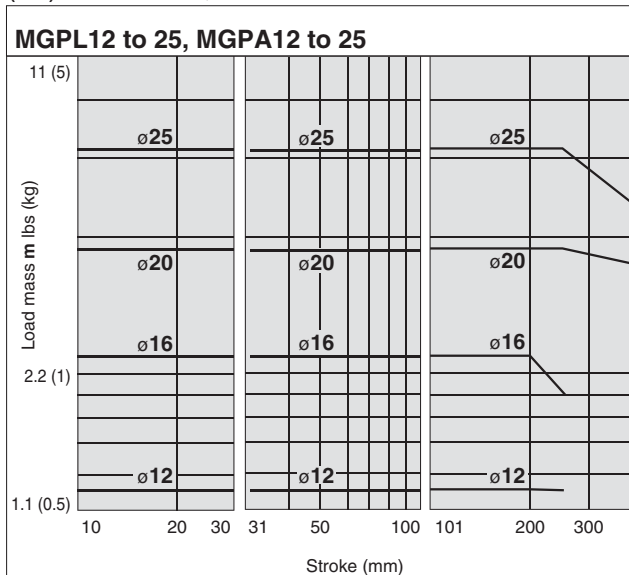

(20) L = 100 mm, V = 400 mm/s

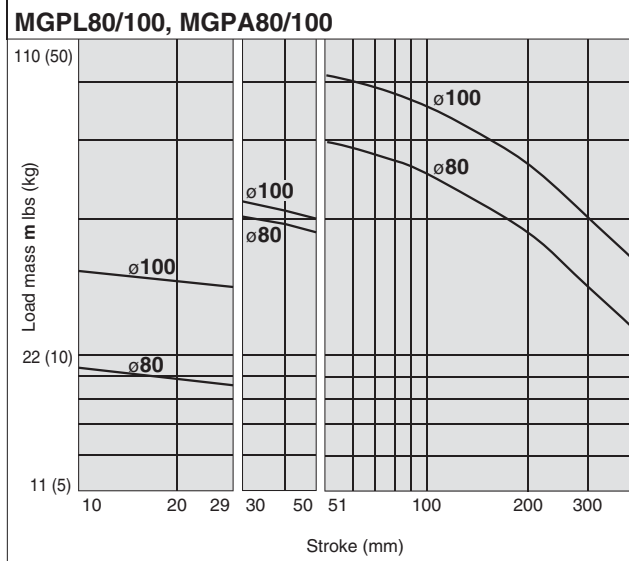
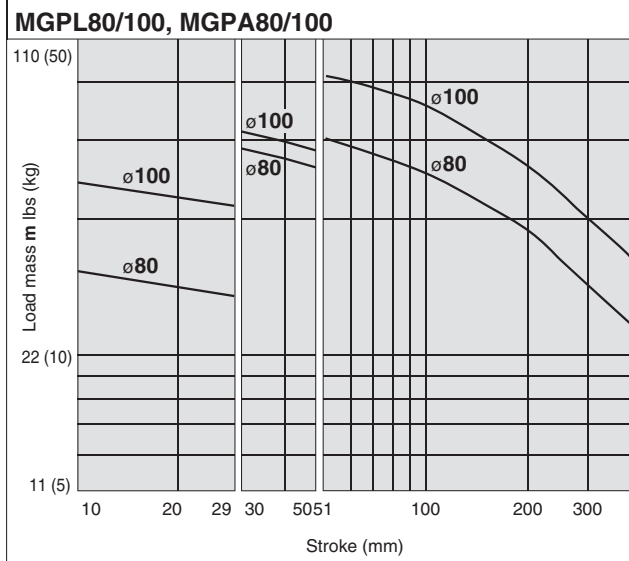
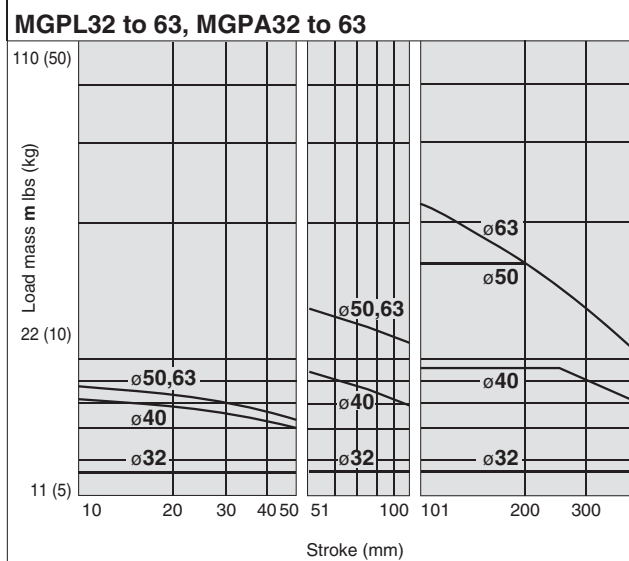
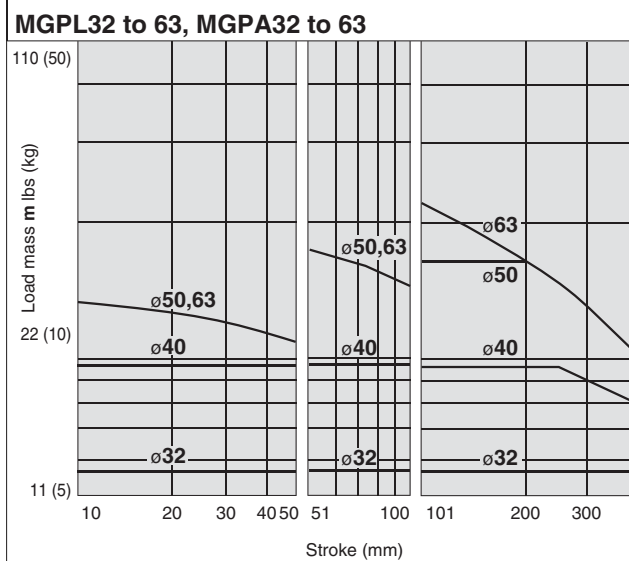
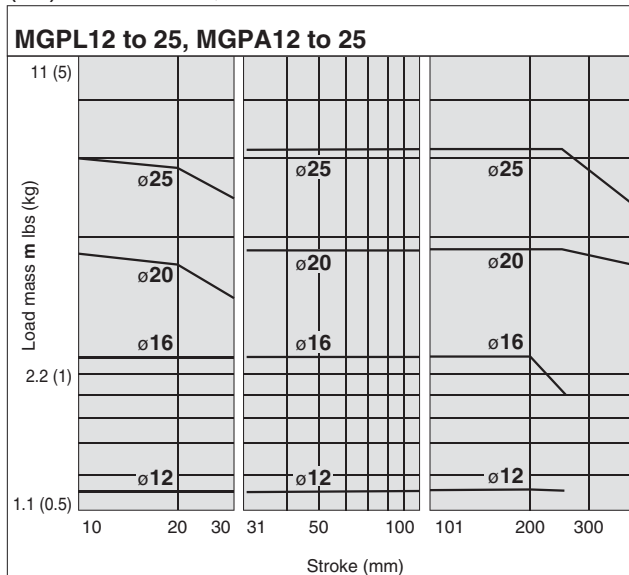

Operating Range when Used as Stopper

Bore Size: $\phi 12$ to $\phi 25$ /MGPM12 to 25 (Slide bearing)

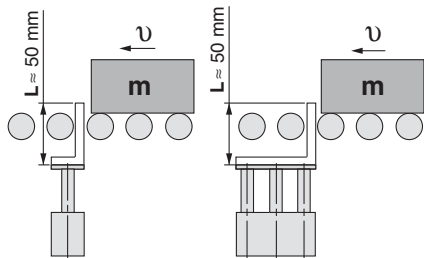

* When selecting a model with a longer L dimension, be sure to choose a bore size which is sufficiently large.

⚠ Caution

Caution on handling

Note 1) When using as a stopper, select a model with 30 stroke or less.

Note 2) The MGPL (Ball bushing) and the MGPA (High precision ball bushing) cannot be used as a stopper.

MGPM12 to 25 (Slide bearing)

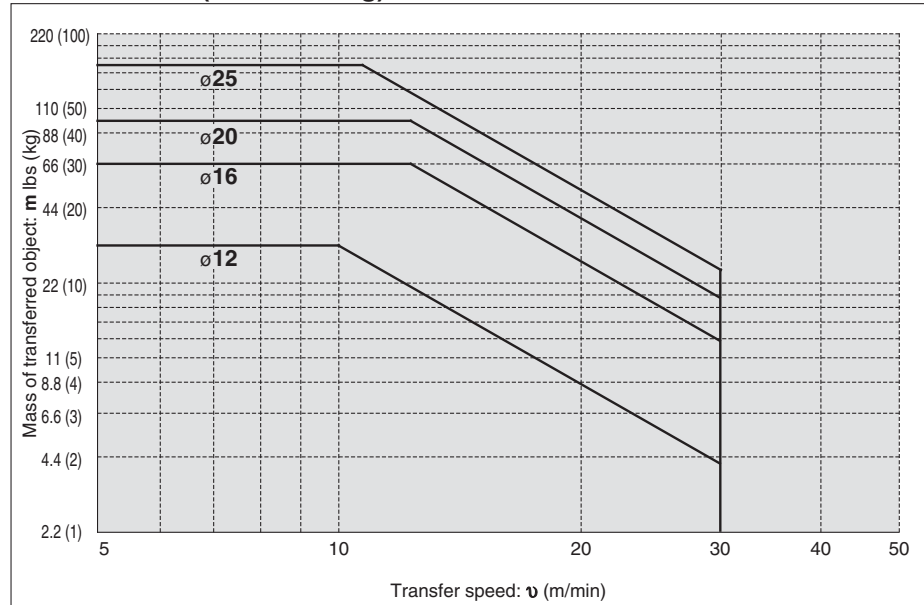

Bore Size: $\phi 32$ to $\phi 100$ /MGPM32 to 100 (Slide bearing)

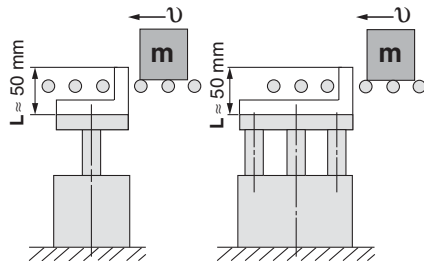

* When selecting a model with a longer L dimension, be sure to choose a bore size which is sufficiently large.

⚠ Caution

Caution on handling

Note 1) When using as a stopper, select a model with 50 stroke or less.

Note 2) The MGPL (Ball bushing) and the MGPA (High precision ball bushing) cannot be used as a stopper.

MGPM32 to 100 (Slide bearing)

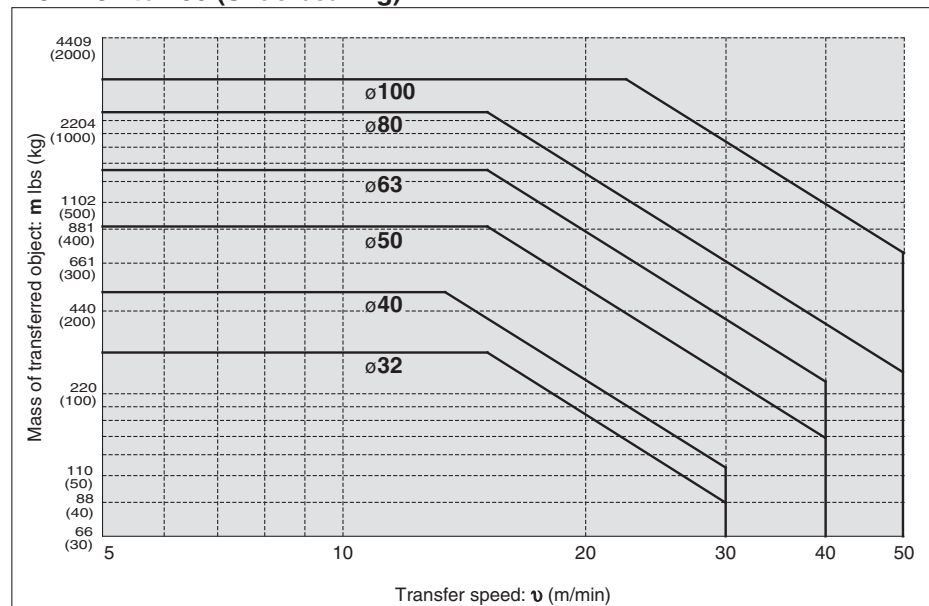

* Refer to graphs (13) and (15) if line pressure is applied by a roller conveyor after the workpiece is stopped.

Construction/Series MGPM

MGPM12 to 25

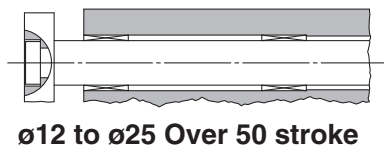
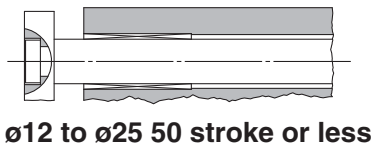
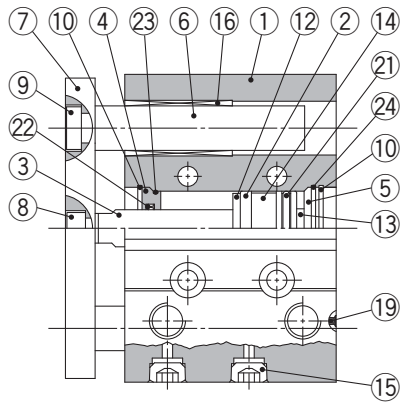

MGPM32 to 100

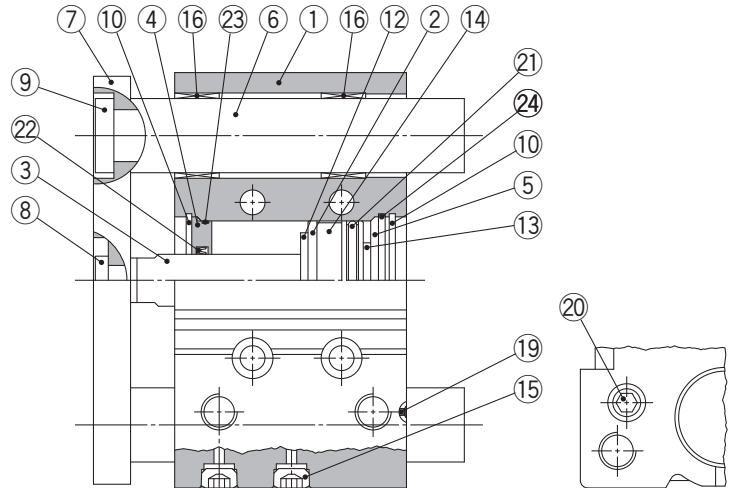

ø63 or more

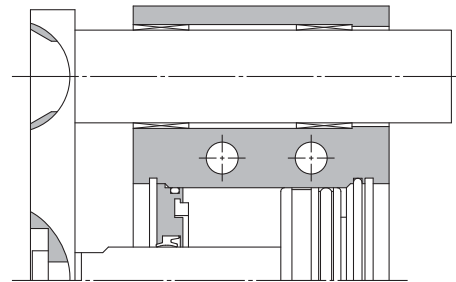

ø50 or more

Component Parts

No.	Description	Material	Note
1	Body	Aluminum alloy	Hard anodized
2	Piston	Aluminum alloy	Chromated
3	Piston rod	Stainless steel	ø12 to ø25
		Carbon steel	ø32 to ø100 Hard chrome plated
4	Collar	Aluminum alloy	Chromated
5	Head cover	Aluminum alloy	ø12 to ø63 Chromated
			ø80, ø100 Painted
6	Guide rod	Carbon steel	Hard chrome plated
7	Plate	Carbon steel	Nickel plated
8	Plate mounting bolt	Carbon steel	Nickel plated
9	Guide bolt	Carbon steel	Nickel plated
10	Retaining ring	Carbon tool steel	Phosphate coated
11	Retaining ring	Carbon tool steel	Phosphate coated
12	Bumper A	Urethane	
13	Bumper B	Urethane	
14	Magnet	—	
15	Plug Hexagon socket head plug	Carbon steel	ø12, ø16 Nickel plated
			ø20 to ø100
16	Slide bearing	Babbitt	

Component Parts

No.	Description	Material	Note
17	Ball bushing		
18	Spacer	Aluminum alloy	
19	Steel ball	Carbon steel	ø12 to ø50
20	Plug	Carbon steel	ø63 to ø100 Nickel plated
21*	Piston seal	NBR	
22*	Rod seal	NBR	
23*	Gasket A	NBR	
24*	Gasket B	NBR	

Replacement Parts/Seal Kit

Bore size (mm)	Kit no.	Contents	Bore size (mm)	Kit no.	Contents
12	MGP12-Z-PS	Set of nos. above ①, ②, ③, ④	40	MGP40-Z-PS	Set of nos. above ①, ②, ③, ④
16	MGP16-Z-PS		50	MGP50-Z-PS	
20	MGP20-Z-PS		63	MGP63-Z-PS	
25	MGP25-Z-PS		80	MGP80-Z-PS	
32	MGP32-Z-PS		100	MGP100-Z-PS	

* Seal kit includes ① to ④. Order the seal kit, based on each bore size.
 * Since the seal kit does not include a grease pack, order it separately.
Grease pack part no.: GR-S-010 (10 g)

Series MGP

Construction/Series MGPL, Series MGPA

MGPL12 to 25
MGPA12 to 25

MGPL32 to 100
MGPA32 to 100

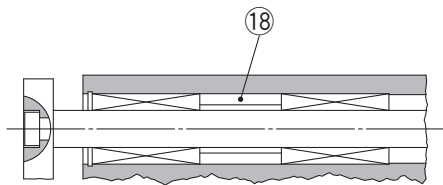
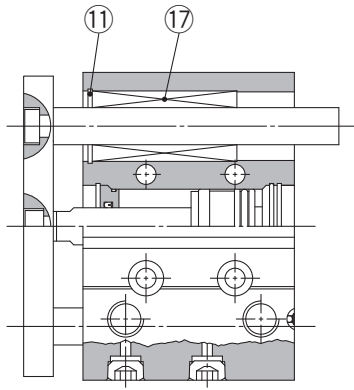

ø12 to ø25 Over 100 stroke

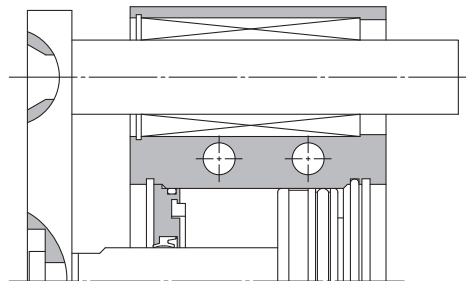
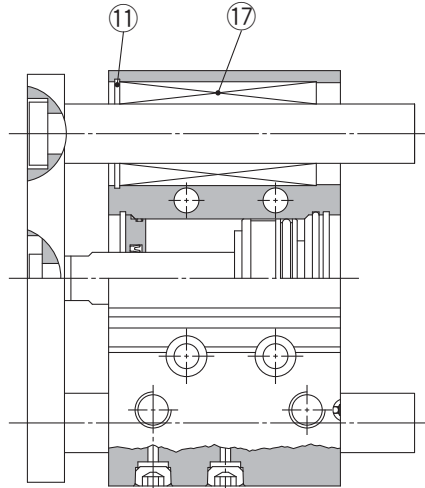

ø50 or more

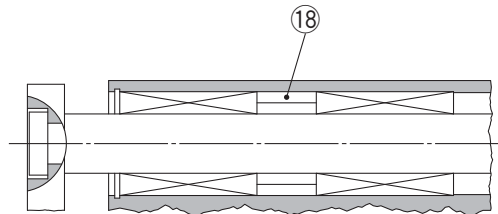

**ø32 to ø63 Over 100 stroke
ø80, ø100 Over 200 stroke**

ø12 to ø25/MGPM, MGPL, MGPA

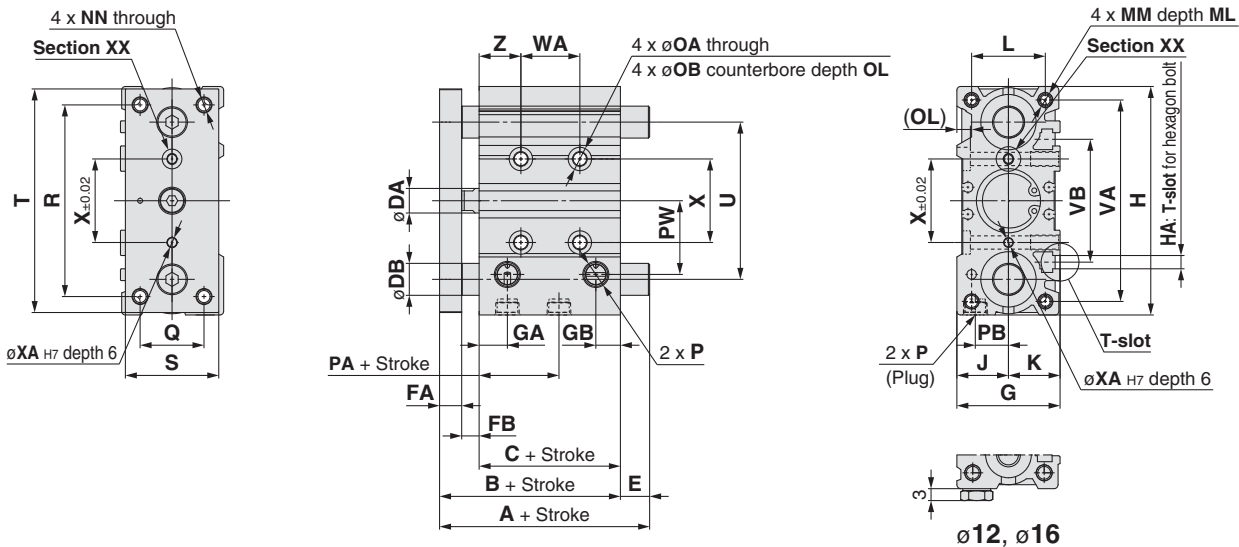
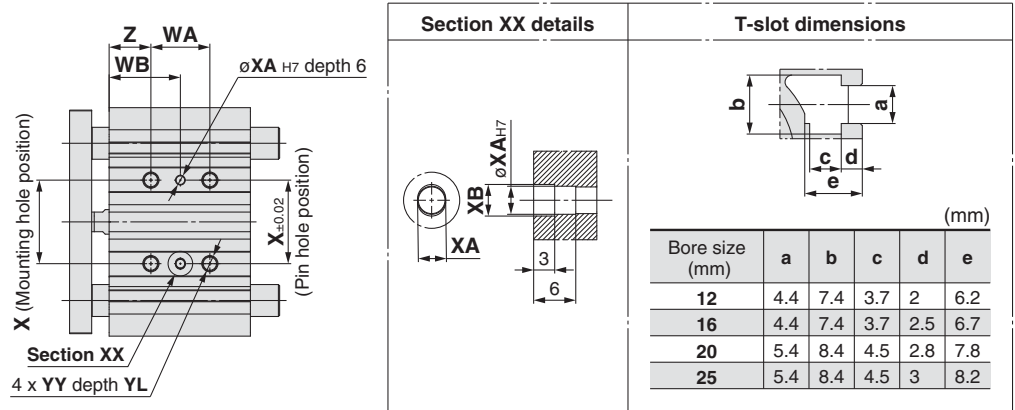

- * The use of a slot (width XA, length XB, depth 3) allows for a relaxed pin pitch tolerance, with the pin hole (øXA_{H7}, depth 6) as the reference, without affecting mounting accuracy.
- * For intermediate strokes other than standard strokes, refer to "Manufacture of Intermediate Strokes" on page 4.
- * For bore sizes with ø12 and ø16, only M5 x 0.8 is available.
- * Choice of Rc, NPT, G port is available for bore sizes with ø20 or more. (Refer to page 3.)

MGPM, MGPL, MGPA Common Dimensions

Bore size (mm)	Standard stroke (mm)	B	C	DA	FA	FB	G	GA	GB	H	HA	J	K	L	MM	ML	NN	OA	OB	OL	P		
																					Nil	TN	TF
12	10,20,30,40,50,75,100	42	29	6	7	6	26	10	7	58	M4	13	13	18	M4 x 0.7	10	M4 x 0.7	4.3	8	4.5	M5 x 0.8	—	—
16	125,150,175,200,250	46	33	8	7	6	30	10.5	7.5	64	M4	15	15	22	M5 x 0.8	12	M5 x 0.8	4.3	8	4.5	M5 x 0.8	—	—
20	20,30,40,50,75,100,125,150	53	37	10	8	8	36	11.5	9	83	M5	18	18	24	M5 x 0.8	13	M5 x 0.8	5.4	9.5	5.5	Rc1/8	NPT1/8	G1/8
25	175,200,250,300,350,400	53.5	37.5	10	9	7	42	11.5	10	93	M5	21	21	30	M6 x 1.0	15	M6 x 1.0	5.4	9.5	5.5	Rc1/8	NPT1/8	G1/8

Bore size (mm)	PA	PB	PW	Q	R	S	T	U	VA	VB	WA				WB				X	XA	XB	YY	YL	Z		
											30 st or less	Over 30 st 100 st or less	Over 100 st 200 st or less	Over 200 st 300 st or less	30 st or less	Over 30 st 100 st or less	Over 100 st 200 st or less	Over 200 st 300 st or less								
12	13	8	18	14	48	22	56	41	50	37	20	40	110	200	—	15	25	60	105	—	23	3	3.5	M5 x 0.8	10	5
16	14.5	10	19	16	54	25	62	46	56	38	24	44	110	200	—	17	27	60	105	—	24	3	3.5	M5 x 0.8	10	5
20	13.5	10.5	25	18	70	30	81	54	72	44	24	44	120	200	300	29	39	77	117	167	28	3	3.5	M6 x 1.0	12	17
25	12.5	13.5	30	26	78	38	91	64	82	50	24	44	120	200	300	29	39	77	117	167	34	4	4.5	M6 x 1.0	12	17

MGPM (Slide bearing) A, DB, E Dimensions

Bore size (mm)	A				DB	E			
	50 st or less	Over 50 st 100 st or less	Over 100 st 200 st or less	Over 200 st		50 st or less	Over 50 st 100 st or less	Over 100 st 200 st or less	Over 200 st
12	42	60.5	82.5	82.5	8	0	18.5	40.5	40.5
16	46	64.5	92.5	92.5	10	0	18.5	46.5	46.5
20	53	77.5	110	110	12	0	24.5	24.5	57
25	53.5	77.5	109.5	109.5	16	0	24	24	56

MGPL (Ball bushing)

MGPA (High precision ball bushing) A, DB, E Dimensions

Bore size (mm)	A				DB	E			
	30 st or less	Over 30 st 100 st or less	Over 100 st 200 st or less	Over 200 st		30 st or less	Over 30 st 100 st or less	Over 100 st 200 st or less	Over 200 st
12	43	55	84.5	84.5	6	1	13	42.5	42.5
16	49	65	94.5	94.5	8	3	19	48.5	48.5
20	59	76	100	117.5	10	6	23	47	64.5
25	65.5	81.5	100.5	117.5	13	12	28	47	64

Series MGP

ø32 to ø63/MGPM, MGPL, MGPA

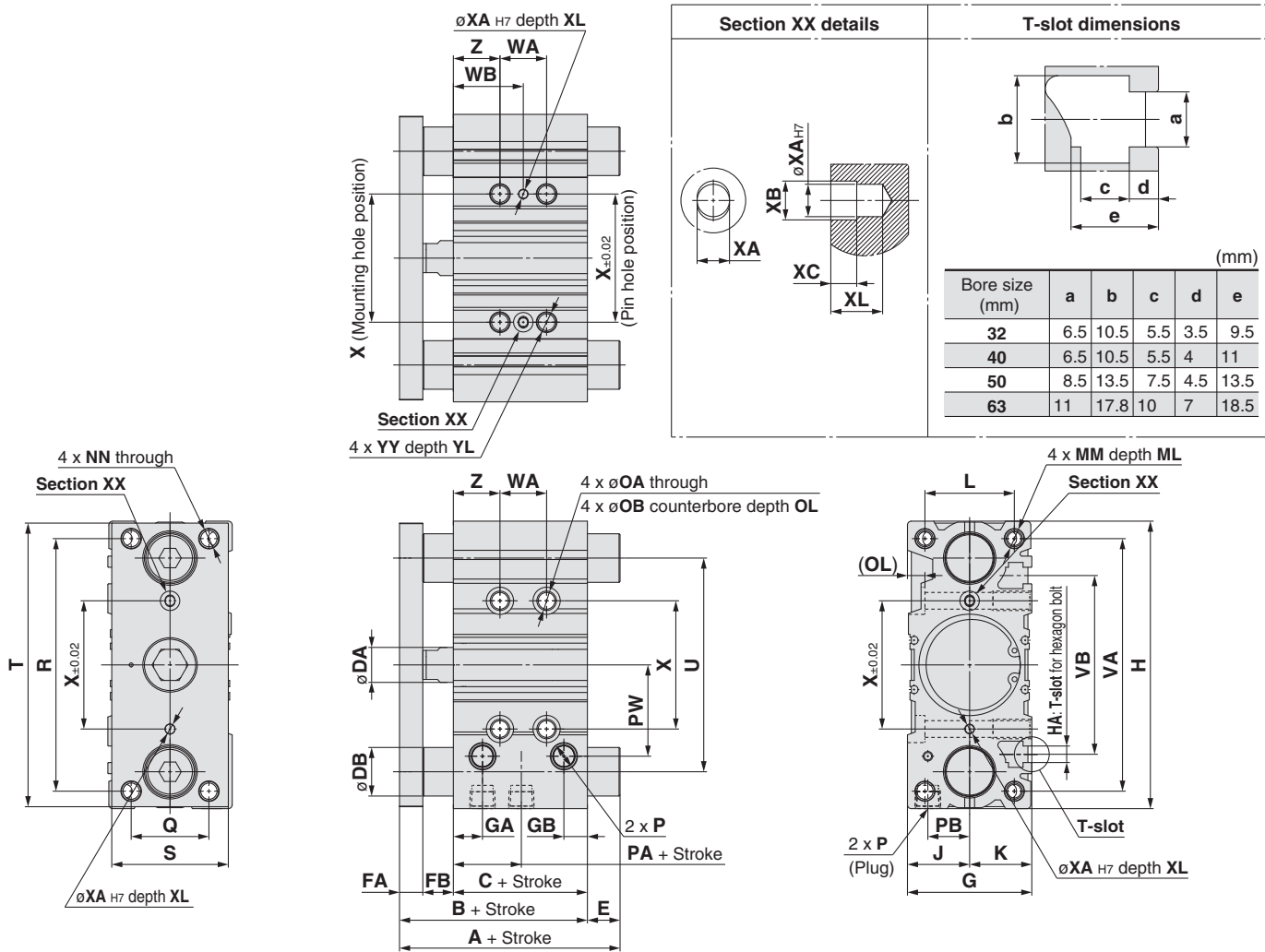

- * The use of a slot (width XA, length XB, depth XC) allows for a relaxed pin pitch tolerance, with the pin hole (øXA_{H7}, depth XL) as the reference, without affecting mounting accuracy.
- * For intermediate strokes other than standard strokes, refer to "Manufacture of Intermediate Strokes" on page 4.
- * Choice of Rc, NPT, G port is available. (Refer to page 3.)

MGPM, MGPL, MGPA Common Dimensions

(mm)

Bore size (mm)	Standard stroke (mm)	B	C	DA	FA	FB	G	GA	GB	H	HA	J	K	L	MM	ML	NN	OA	OB	OL	P		
																					NII	TN	TF
32	25,50,75	59.5	37.5	14	10	12	48	12	9	112	M6	24	24	34	M8 x 1.25	20	M8 x 1.25	6.7	11	7.5	Rc1/8	NPT1/8	G1/8
40	100,125,150	66	44	14	10	12	54	15	12	120	M6	27	27	40	M8 x 1.25	20	M8 x 1.25	6.7	11	7.5	Rc1/8	NPT1/8	G1/8
50	175,200,250	72	44	18	12	16	64	15	12	148	M8	32	32	46	M10 x 1.5	22	M10 x 1.5	8.6	14	9	Rc1/4	NPT1/4	G1/4
63	300,350,400	77	49	18	12	16	78	15.5	13.5	162	M10	39	39	58	M10 x 1.5	22	M10 x 1.5	8.6	—	9	Rc1/4	NPT1/4	G1/4

Bore size (mm)	PA	PB	PW	Q	R	S	T	U	VA	VB	WA				WB				X	XA	XB	XC	XL	YY	YL	Z		
											25 st or less	Over 25 st 100 st or less	Over 100 st 200 st or less	Over 200 st 300 st or less	25 st or less	Over 25 st 100 st or less	Over 100 st 200 st or less	Over 200 st 300 st or less										
32	6.5	16	35.5	30	96	44	110	78	98	63	24	48	124	200	300	33	45	83	121	171	42	4	4.5	3	6	M8 x 1.25	16	21
40	13	18	39.5	30	104	44	118	86	106	72	24	48	124	200	300	34	46	84	122	172	50	4	4.5	3	6	M8 x 1.25	16	22
50	9	21.5	47	40	130	60	146	110	130	92	24	48	124	200	300	36	48	86	124	174	66	5	6	4	8	M10 x 1.5	20	24
63	13	28	58	50	130	70	158	124	142	110	28	52	128	200	300	38	50	88	124	174	80	5	6	4	8	M10 x 1.5	20	24

MGPM (Slide bearing) A, DB, E Dimensions

(mm)

Bore size (mm)	A			DB	E		
	50 st or less	Over 50 st 200 st or less	Over 200 st		50 st or less	Over 50 st 200 st or less	Over 200 st
32	75	93.5	129.5	20	15.5	34	70
40	75	93.5	129.5	20	9	27.5	63.5
50	88.5	109.5	150.5	25	16.5	37.5	78.5
63	88.5	109.5	150.5	25	11.5	32.5	73.5

MGPL (Ball bushing)

MGPA (High precision ball bushing) A, DB, E Dimensions

Bore size (mm)	A				DB	E			
	50 st or less	Over 50 st 100 st or less	Over 100 st 200 st or less	Over 200 st		50 st or less	Over 50 st 100 st or less	Over 100 st 200 st or less	Over 200 st
32	79.5	96.5	116.5	138.5	16	20	37	57	79
40	79.5	96.5	116.5	138.5	16	13.5	30.5	50.5	72.5
50	91.5	112.5	132.5	159.5	20	19.5	40.5	60.5	87.5
63	91.5	112.5	132.5	159.5	20	14.5	35.5	55.5	82.5

ø80, ø100/MGPM, MGPL, MGPA

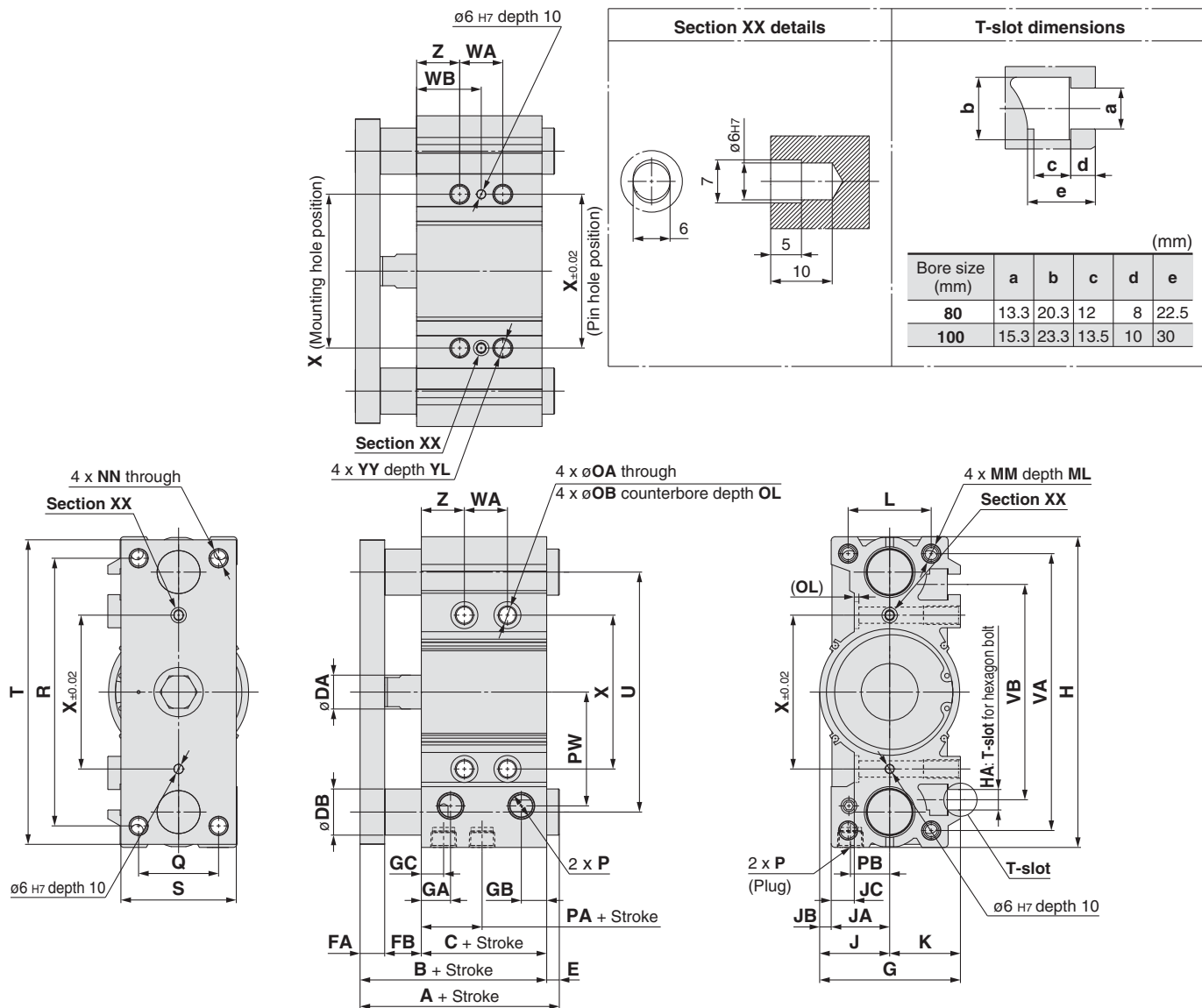

* The use of a slot (width X6, length 7, depth 5) allows for a relaxed pin pitch tolerance, with the pin hole (ø6H7, depth 10) as the reference, without affecting mounting accuracy.
 * For intermediate strokes other than standard strokes, refer to "Manufacture of Intermediate Strokes" on page 4.
 * Choice of Rc, NPT, G port is available. (Refer to page 3.)

MGPM, MGPL, MGPA Common Dimensions

Bore size (mm)	Standard stroke (mm)	B	C	DA	FA	FB	G	GA	GB	GC	H	HA	J	JA	JB	JC	K	L	MM	ML	NN	OA	OB	OL	P		
																									Nil	TN	TF
80	25,50,75,100 125,150,175,200 250,300,350,400	96.5	56.5	22	16	24	91.5	19	16.5	14.5	202	M12	45.5	38	7.5	15	46	54	M12 x 1.75	25	M12 x 1.75	10.6	17.5	3	Rc3/8	NPT3/8	G3/8
100		116	66	26	19	31	111.5	22.5	20.5	18	240	M14	55.5	45	10.5	10	56	62	M14 x 2.0	31	M14 x 2.0	12.5	20	8	Rc3/8	NPT3/8	G3/8

Bore size (mm)	PA	PB	PW	Q	R	S	T	U	VA	VB	WA					WB					X	YY	YL	Z
											25 st or less	Over 25 st 100 st or less	Over 100 st 200 st or less	Over 200 st 300 st or less	Over 300 st	25 st or less	Over 25 st 100 st or less	Over 100 st 200 st or less	Over 200 st 300 st or less	Over 300 st				
80	14.5	25.5	74	52	174	75	198	156	180	140	28	52	128	200	300	42	54	92	128	178	100	M12 x 1.75	24	28
100	17.5	32.5	89	64	210	90	236	188	210	166	48	72	148	220	320	35	47	85	121	171	124	M14 x 2.0	28	11

MGPM (Slide bearing) A, DB, E Dimensions

Bore size (mm)	A			DB	E		
	50 st or less	Over 50 st 200 st or less	Over 200 st		50 st or less	Over 50 st 200 st or less	Over 200 st
80	104.5	131.5	180.5	30	8	35	84
100	126.5	151.5	190.5	36	10.5	35.5	74.5

MGPL (Ball bushing)

MGPA (High precision ball bushing) A, DB, E Dimensions

Bore size (mm)	A				DB	E			
	25 st or less	Over 25 st 50 st or less	Over 50 st 200 st or less	Over 200 st		25 st or less	Over 25 st 50 st or less	Over 50 st 200 st or less	Over 200 st
80	104.5	128.5	158.5	191.5	25	8	32	62	95
100	119.5	145.5	178.5	201.5	30	3.5	29.5	62.5	85.5

Series MGP

Auto Switch Mounting 1

Auto Switch Proper Mounting Position (Detection at Stroke End) and Its Mounting Height

- D-A9□
- D-A9□V
- D-M9□
- D-M9□V
- D-M9□W
- D-M9□WV
- D-M9□A
- D-M9□AV

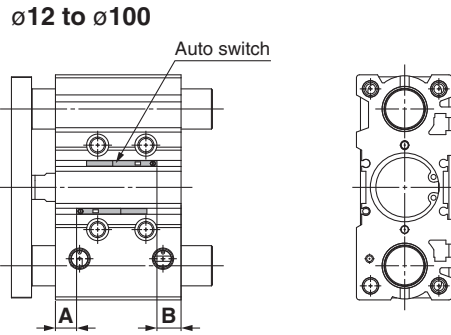

D-P3DW

ø25 to ø63

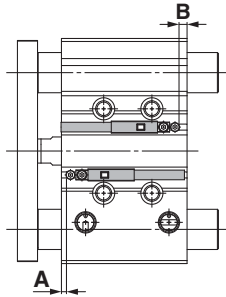

ø80, ø100

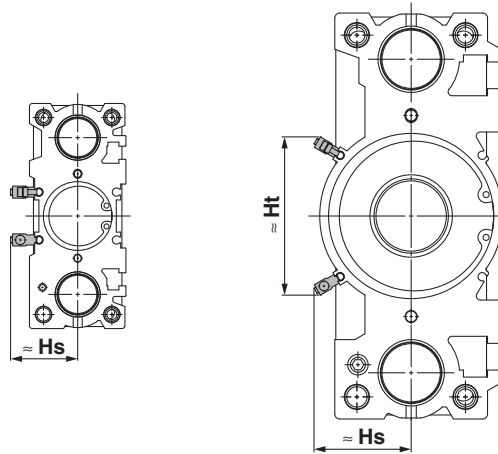

Auto Switch Proper Mounting Position Applicable Cylinder Series: MGP

(mm)

Auto switch model	D-M9□ D-M9□V D-M9□W D-M9□WV D-M9□A D-M9□AV		D-A9□ D-A9□V		D-P3DW	
	A	B	A	B	A	B
12	7.5	9.5	3.5	5.5	—	—
16	10.5	10.5	6.5	6.5	—	—
20	12.5	12.5	8.5	8.5	—	—
25	11.5	14	7.5	10	2	4.5
32	12.5	13	8.5	9	3	3.5
40	15.5	16.5	11.5	12.5	6	7
50	14.5	17	10.5	13	5.5	8
63	16.5	20	12.5	16	7	11
80	18	26	14	22	8.5	17
100	21.5	32.5	17.5	28.5	12	23

Auto Switch Mounting Height

(mm)

Auto switch model	D-A9□ D-M9□ D-M9□W D-M9□A		D-A9□V		D-M9□V D-M9□WV D-M9□AV		D-P3DW	
	Hs	Hs	Ht	Hs	Ht	Hs	Ht	
12	13.5	17	—	19.5	—	—	—	
16	16	19.5	—	22	—	—	—	
20	18.5	22	—	24.5	—	—	—	
25	20.5	24	—	26	—	30	—	
32	23	26.5	—	29	—	33	—	
40	27	30.5	—	33	—	37	—	
50	32.5	36	—	38.5	—	42.5	—	
63	39.5	43	—	45.5	—	49.5	—	
80	40	43	71.5	45	74	48	78.5	
100	50	53	83	55	85.5	58	90	

Note) Adjust the auto switch after confirming the operating conditions in the actual setting.

Minimum Stroke for Auto Switch Mounting

(mm)											
Auto switch model	No. of auto switches mounted	ø12	ø16	ø20	ø25	ø32	ø40	ø50	ø63	ø80	ø100
D-A9□	1 pc.	5 Note 1)			5						
	2 pcs.	10 Note 1)			10						
D-A9□V D-M9□V	1 pc.	5									
	2 pcs.	10									
D-M9□	1 pc.	5 Note 1)				5					
	2 pcs.	10 Note 1)	10								
D-M9□W	1 pc.	5 Note 2)									
	2 pcs.	10 Note 2)	10								
D-M9□WV D-M9□AV	1 pc.	5 Note 2)									
	2 pcs.	10									
D-M9□A	1 pc.	5 Note 2)									
	2 pcs.	10 Note 2)									
D-P3DW	1 pc.	—			15						
	2 pcs.	—			15						

Note 1) Confirm that it is possible to secure the minimum bending radius of 10 mm of the auto switch lead wire before use.

Note 2) Confirm that it is possible to securely set the auto switch(es) within the range of indicator green light ON range before use.

For in-line entry type, please also consider Note 1) shown above.

Note 3) The D-P3DW can be mounted on bore sizes ø25 to ø100.

Note 4) Bore sizes available with end-lock are ø20 to ø100.

Operating Range

(mm)											
Auto switch model	Bore size										
	12	16	20	25	32	40	50	63	80	100	
D-A9□/A9□V	7	9	9	9	9.5	9.5	9.5	11	10.5	10.5	
D-M9□/M9□V D-M9□W/M9□WV D-M9□A/M9□AV	3.5	5	5	5	6	6	6	6.5	6	7	

* Since the operating range is provided as a guideline including hysteresis, it cannot be guaranteed (assuming approximately ±30% dispersion).

It may vary substantially depending on an ambient environment.

* Please consult SMC for magnetic field resistant auto switch D-P3DW.

Other than the applicable auto switches listed in “How to Order”, the following auto switches are mountable.

Refer to pages 1719 to 1827 in Best Pneumatics No. 3 for detailed specifications.

Type	Model	Electrical entry	Features
Solid state switch	D-P4DW□	Grommet (In-line)	Diagnostic indication (2-color display) Bore size: ø32 to ø100

* With pre-wired connector is also available for solid state auto switches. For details, refer to pages 1784 and 1785 in Best Pneumatics No. 3.

* Normally closed (NC = b contact) solid state auto switches (D-F9G/F9H) are also available. For details, refer to page 1746 in Best Pneumatics No. 3.

* When installing the D-P4DW□, use the BMG7-032 auto switch mounting bracket.

Series MGP

Auto Switch Mounting 2

Auto Switch Mounting Brackets/Part No.

Applicable Cylinder Series: MGPM, MGPL, MGPA

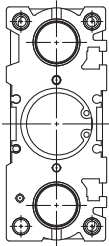
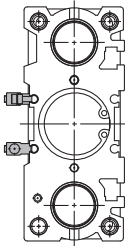
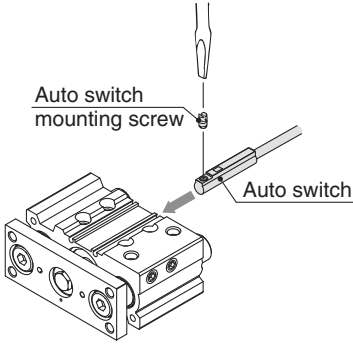
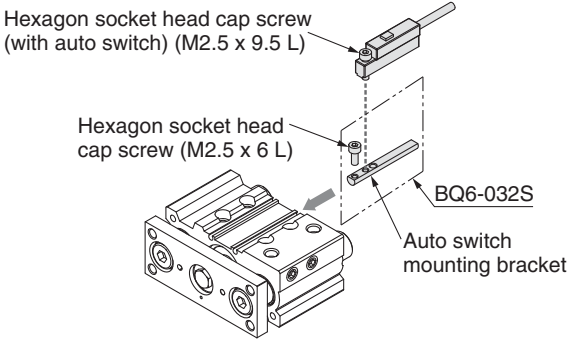
Applicable auto switches	D-M9□/M9□V D-M9□W/M9□WV D-M9□A/M9□AV D-A9□/A9□V	D-P3DW						
Bore size (mm)	ø12 to ø100	ø25 to ø100						
Auto switch mounting bracket part no.	—	BQ6-032S						
Auto switch mounting bracket fitting parts lineup/Weight	—	① Hexagon socket head cap screw (M2.5 x 6 L) ② Auto switch mounting bracket (nut) Weight: 5 g						
Auto switch mounting surfaces	Surfaces with auto switch mounting slot	Surfaces with auto switch mounting slot						
								
Mounting of auto switch	 <p>• When tightening the auto switch mounting screw, use a watchmakers' screwdriver with a handle 5 to 6 mm in diameter.</p> <p>Tightening Torque for Auto Switch Mounting Screw (N·m)</p> <table border="1"> <thead> <tr> <th>Auto switch model</th> <th>Tightening torque</th> </tr> </thead> <tbody> <tr> <td>D-M9□(V) D-M9□W(V) D-M9□A(V)</td> <td>0.05 to 0.15</td> </tr> <tr> <td>D-A9□(V)</td> <td>0.10 to 0.20</td> </tr> </tbody> </table>	Auto switch model	Tightening torque	D-M9□(V) D-M9□W(V) D-M9□A(V)	0.05 to 0.15	D-A9□(V)	0.10 to 0.20	<ol style="list-style-type: none"> Insert the protrusion on the bottom of the auto switch into the mating part of the auto switch mounting bracket and fix the auto switch and the auto switch mounting bracket temporarily by tightening the attached hexagon socket head cap screw (M2.5 x 9.5 L) 1 to 2 turns. Insert the temporarily tightened mounting bracket into the mating groove of the cylinder tube, and slide the auto switch onto the cylinder tube through the groove. Check the detecting position of the auto switch and fix the auto switch firmly with the hexagon socket head cap screw (M2.5 x 6 L, M2.5 x 9.5 L).* If the detecting position is changed, go back to step ②. <p>* The hexagon socket head cap screw (M2.5 x 6 L) is used to fix the mounting bracket and cylinder tube. This enables the replacement of the auto switch without adjusting the auto switch position.</p> <p>Note 1) Ensure that the auto switch is covered with the mating groove to protect the auto switch. Note 2) The tightening torque for the hexagon socket head cap screw (M2.5 x 6 L, M2.5 x 9.5 L) is 0.2 to 0.3 N·m. Note 3) Tighten the hexagon socket head cap screws evenly.</p> 
Auto switch model	Tightening torque							
D-M9□(V) D-M9□W(V) D-M9□A(V)	0.05 to 0.15							
D-A9□(V)	0.10 to 0.20							

Note) Auto switch mounting brackets and auto switches are enclosed with the cylinder for shipment.
For an environment that needs the water-resistant auto switch, select the D-M9□A(V) type.

Prior to Use

Auto Switch Connection and Example

Basic Wiring

Solid state 3-wire, NPN

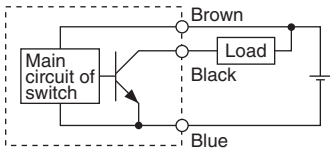

Solid state 3-wire, PNP

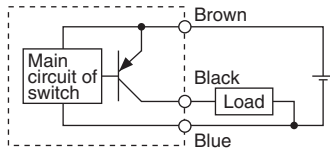

2-wire (Solid state)

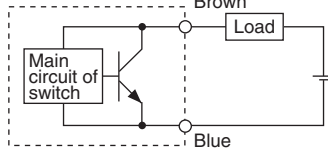

2-wire (Reed)

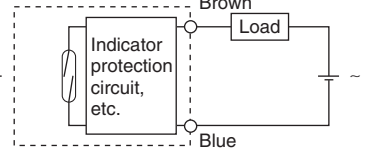

(Power supply for switch and load are separate.)

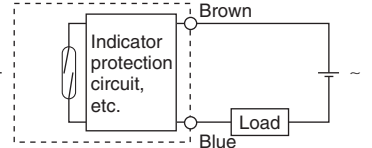
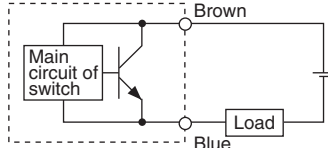
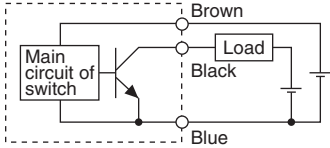

Example of Connection with PLC (Programmable Logic Controller)

• Sink input specifications 3-wire, NPN

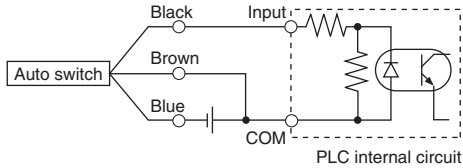

• Source input specifications 3-wire, PNP

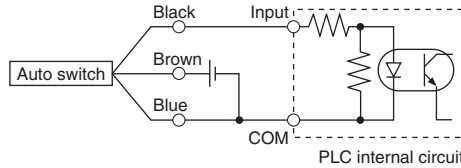

Connect according to the applicable PLC input specifications, as the connection method will vary depending on the PLC input specifications.

2-wire

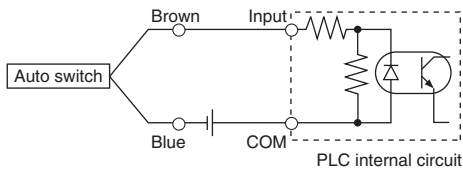

2-wire

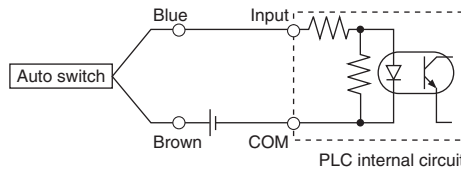

Example of AND (Series) and OR (Parallel) Connection

• 3-wire

AND connection for NPN output (Using relays)

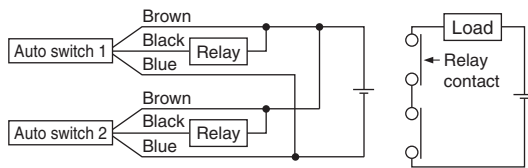

AND connection for NPN output (Performed with auto switches only)

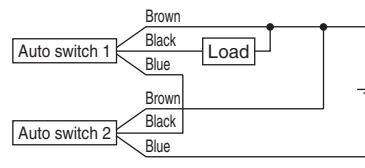

OR connection for NPN output

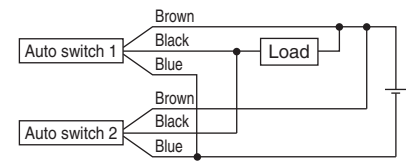

The indicator lights will light up when both of the auto switches are in the ON state.

• 2-wire

2-wire with 2-switch AND connection

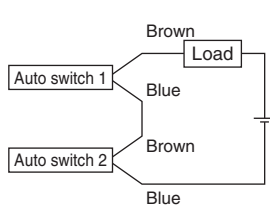

When two auto switches are connected in series, malfunction may occur because the load voltage will decrease in the ON state. The indicator lights will light up when both of the auto switches are in the ON state.

$$\begin{aligned} \text{Load voltage at ON} &= \text{Power supply voltage} - \text{Residual voltage} \times 2 \text{ pcs.} \\ &= 24 \text{ V} - 4 \text{ V} \times 2 \text{ pcs.} \\ &= 16 \text{ V} \end{aligned}$$

Example: Power supply voltage 24 VDC
Auto switch internal voltage drop 4 V

2-wire with 2-switch OR connection

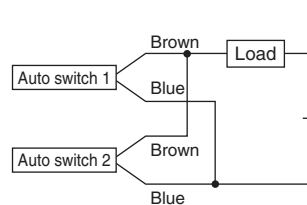

(Solid state)

When two auto switches are connected in parallel, malfunction may occur because the load voltage will increase in the OFF state.

$$\begin{aligned} \text{Load voltage at OFF} &= \text{Leakage current} \times 2 \text{ pcs.} \times \text{Load impedance} \\ &= 1 \text{ mA} \times 2 \text{ pcs.} \times 3 \text{ k}\Omega \\ &= 6 \text{ V} \end{aligned}$$

Example: Load impedance 3 kΩ
Auto switch leakage current 1 mA

(Reed)

Because there is no leakage current, the load voltage will not increase in the OFF state. However, depending on the number of auto switches in the ON state, the indicator lights may sometimes grow dim or not light up, due to the dispersion and reduction of the current flowing to the auto switches.

Global Manufacturing, Distribution and Service Network

Worldwide Subsidiaries

North & South America

- U.S.A. SMC Corporation of America
- CANADA SMC Pneumatics (Canada) Ltd.
- MEXICO SMC Corporation (México), S.A. de C.V.
- BRAZIL SMC Pneumáticos do Brasil Ltda.
- CHILE SMC Pneumatics (Chile) S.A.
- COLOMBIA SMC Colombia Sucursal de SMC Chile S.A.
- ARGENTINA SMC Argentina S.A.
- BOLIVIA SMC Pneumatics Bolivia S.r.l.
- VENEZUELA SMC Neumatica Venezuela S.A.
- PERU (Distributor) IMPECO Automatización Industrial S.A.C.
- ECUADOR (Distributor) ASSISTECH CIA. LTDA.

Asia/Oceania

- CHINA SMC (China) Co., Ltd.
- CHINA SMC Pneumatics (Guangzhou) Ltd.
- HONG KONG SMC Pneumatics (Hong Kong) Ltd.
- TAIWAN SMC Pneumatics (Taiwan) Co., Ltd.
- KOREA SMC Pneumatics Korea Co., Ltd.
- SINGAPORE SMC Pneumatics (S.E.A.) Pte. Ltd.
- MALAYSIA SMC Pneumatics (S.E.A.) Sdn. Bhd.
- THAILAND SMC (Thailand) Ltd.
- PHILIPPINES Shoketsu SMC Corporation
- INDIA SMC Pneumatics (India) Pvt. Ltd.
- ISRAEL (Distributor) Baccara Geva A.C.S. Ltd.
- INDONESIA (Distributor) PT. Sinar Mutiara Cemerlang
- VIETNAM (Distributor) Dy Dan Trading Co., Ltd.
- PAKISTAN (Distributor) Jubilee Corporation

Asia/Oceania

- SRI LANKA (Distributor) Electro-Serv (Pvt.) Ltd.
- IRAN (Distributor) Abzarchian Co. Ltd.
- U.A.E. (Distributor) Machinery People Trading Co. L.L.C.
- KUWAIT (Distributor) Esco Kuwait Equip & Petroleum App. Est.
- SAUDI ARABIA (Distributor) Assaggaft Trading Est.
- BAHRAIN (Distributor) Mohammed Jalal & Sons W.L.L. Technical & Automotive Services
- SYRIA (Distributor) Miak Corporation
- JORDAN (Distributor) Atafawok Trading Est.
- BANGLADESH (Distributor) Chemie International
- AUSTRALIA SMC Pneumatics (Australia) Pty. Ltd.
- NEW ZEALAND SMC Pneumatics (N.Z.) Ltd.
- JAPAN SMC Corporation

Europe/Africa

- GERMANY SMC Pneumatik GmbH
- SWITZERLAND SMC Pneumatik AG
- U.K. SMC Pneumatics (U.K.) Ltd.
- FRANCE SMC Pneumatique SA
- SPAIN / PORTUGAL SMC España S.A.
- ITALY SMC Italia S.p.A.
- GREECE SMC HELLAS E.P.E
- IRELAND SMC Pneumatics (Ireland) Ltd.
- NETHERLANDS (Associated company) SMC Pneumatics BV
- BELGIUM (Associated company) SMC Pneumatics N.V./S.A.
- DENMARK SMC Pneumatik A/S
- AUSTRIA SMC Pneumatik GmbH (Austria)

Europe/Africa

- CZECH REPUBLIC SMC Industrial Automation CZ s.r.o.
- HUNGARY SMC Hungary Ipari Automatizálási Kft.
- POLAND SMC Industrial Automation Polska Sp. z o.o.
- SLOVAKIA SMC Priemyselná Automatizácia Spol s.r.o.
- SLOVENIA SMC Industrijska Avtomatika d.o.o.
- BULGARIA SMC Industrial Automation Bulgaria EOOD
- CROATIA SMC Industrijska Avtomatika d.o.o.
- BOSNIA AND HERZEGOVINA (Distributor) A.M. Pneumatik d.o.o.
- SERBIA (Distributor) Best Pneumatics d.o.o.
- UKRAINE (Distributor) PNEUMOTEC Corp.
- FINLAND SMC Pneumatics Finland Oy
- NORWAY SMC Pneumatics Norway AS
- SWEDEN SMC Pneumatics Sweden AB
- ESTONIA SMC Pneumatics Estonia Oü
- LATVIA SMC Pneumatics Latvia SIA
- LITHUANIA (LIETUVA) UAB "SMC Pneumatics"
- ROMANIA SMC Romania S.r.l.
- RUSSIA SMC Pneumatik LLC.
- KAZAKHSTAN SMC Kazakhstan, LLC.
- TURKEY (Distributor) Entek Pnömatik Sanayi ve Ticaret Şirketi
- MOROCCO (Distributor) Soraflex
- TUNISIA (Distributor) Byms
- EGYPT (Distributor) Saadani Trading & Industrial Services
- NIGERIA (Distributor) Faraday Engineering Company Ltd.
- SOUTH AFRICA (Distributor) Hyflo Southern Africa (Pty.) Ltd.

U.S. & Canadian Sales Offices

WEST

- Austin
- Dallas
- Los Angeles
- Phoenix
- Portland
- San Francisco
- Vancouver

EAST

- Atlanta
- Birmingham
- Boston
- Charlotte
- Nashville
- New Jersey
- Richmond
- Rochester
- Tampa
- Montreal

CENTRAL

- Chicago
- Cincinnati
- Cleveland
- Detroit
- Indianapolis
- Milwaukee
- Minneapolis
- St. Louis
- Toronto
- Windsor

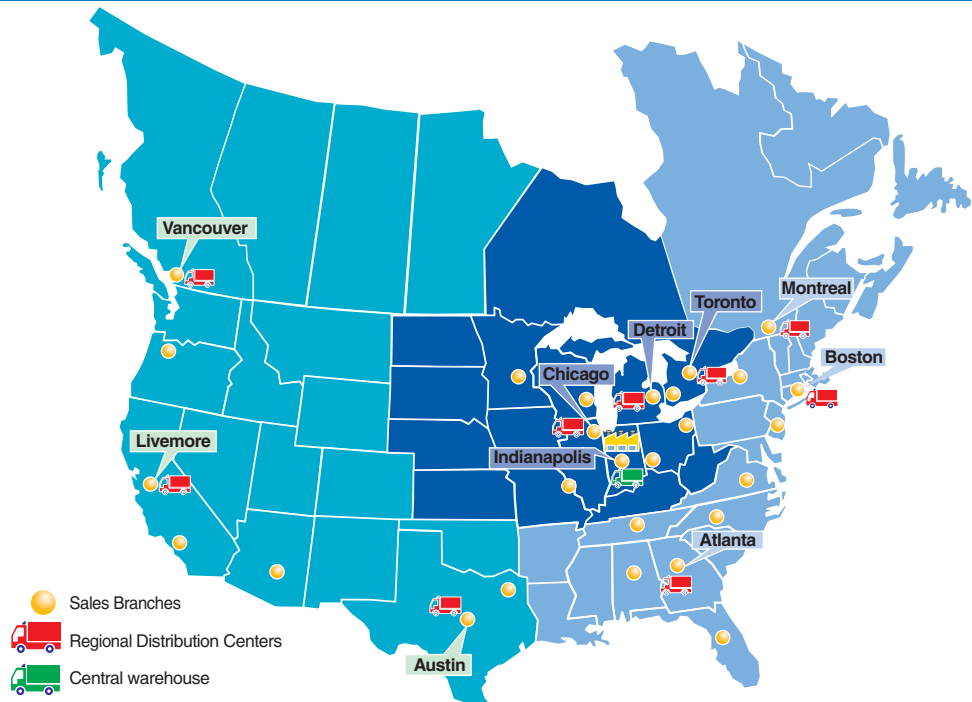

- Sales Branches
- Regional Distribution Centers
- Central warehouse

SMC Corporation of America
10100 SMC Blvd., Noblesville, IN 46060
www.smcusa.com

SMC Pneumatics (Canada) Ltd.
www.smcpcanada.com

(800) SMC.SMC1 (762-7621)

e-mail: sales@smcusa.com

For International Inquiries: www.smcworld.com

