

Clean One-touch Fittings

Series *KP/KPQ/KPG*

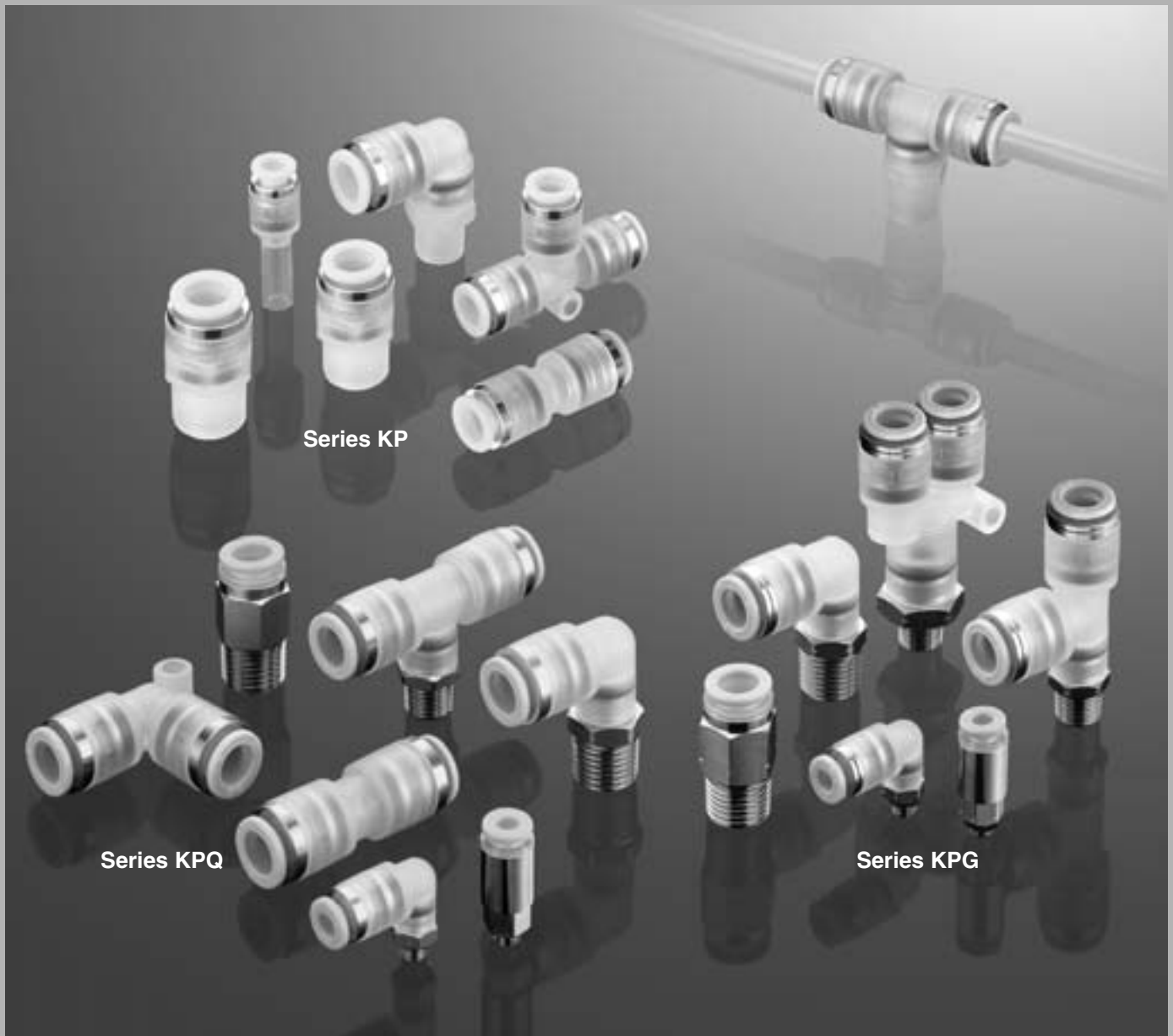

- K**
- M
- H
- KK
- D
- MS
- LQ
- MQR
- T

One-touch fittings and tubing for blowing systems and drive air

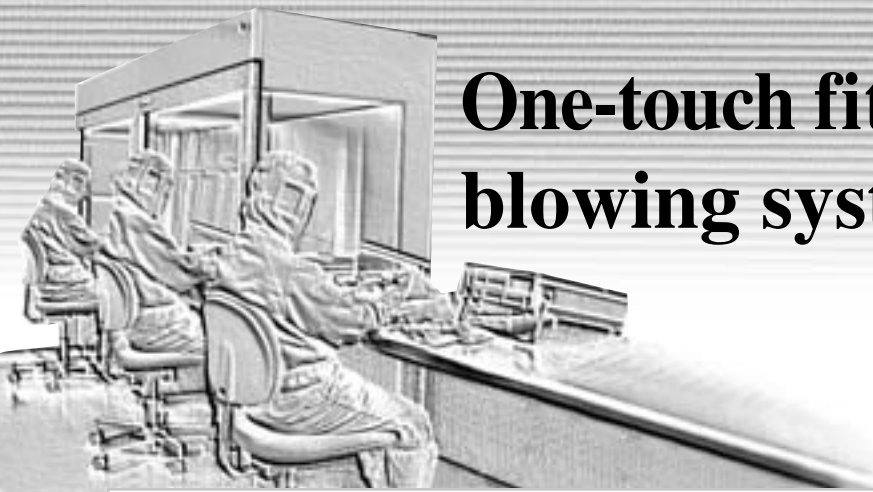

One-touch fittings (for blowing)

Series KP

- Completely oil free (Rubber parts are fluorine-coated.)
- Liquid-contact areas are non-metallic
- Parts cleaning, assembly and double packaging in a clean room
- Can be used for vacuum (-100kPa)



Series KP

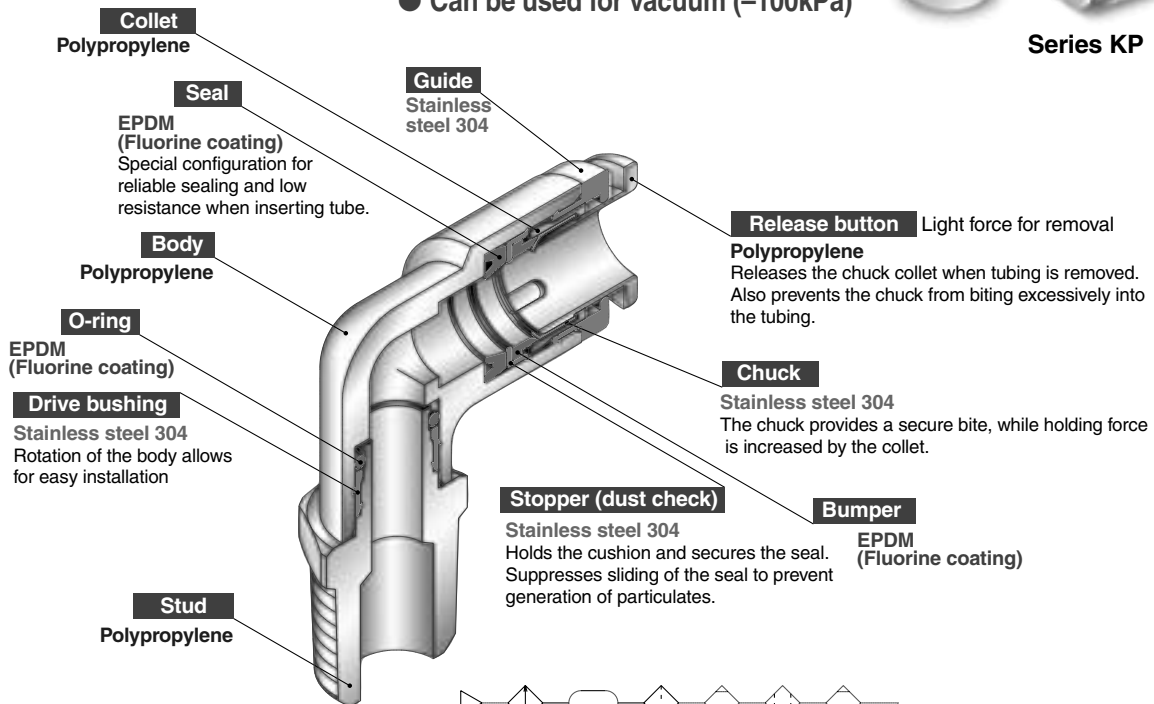

■ Clean blowing system

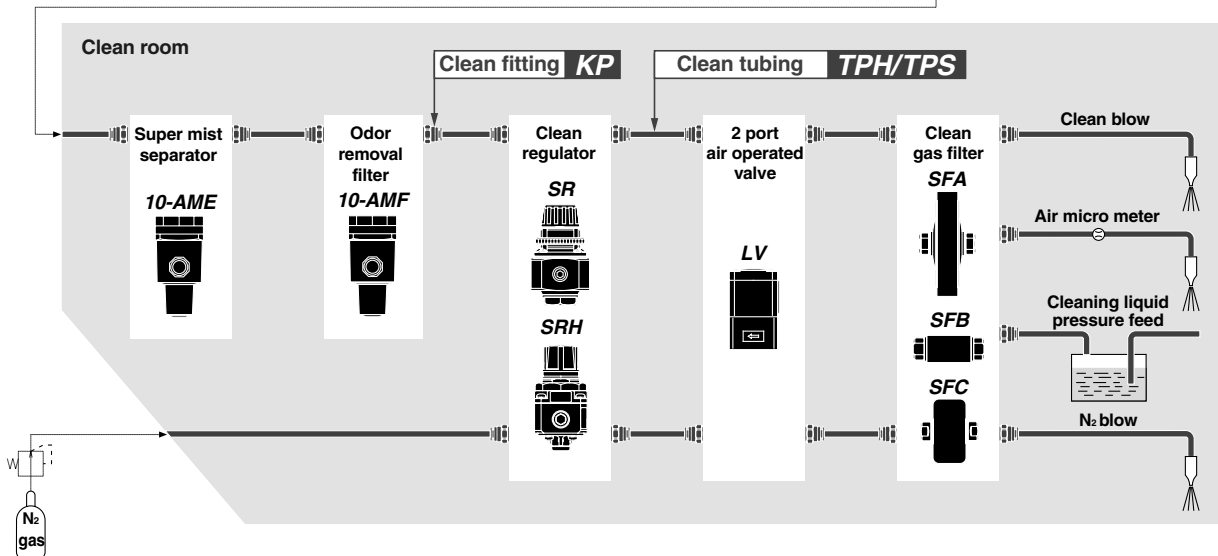
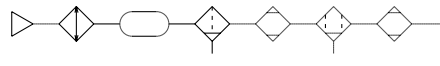

clean room systems

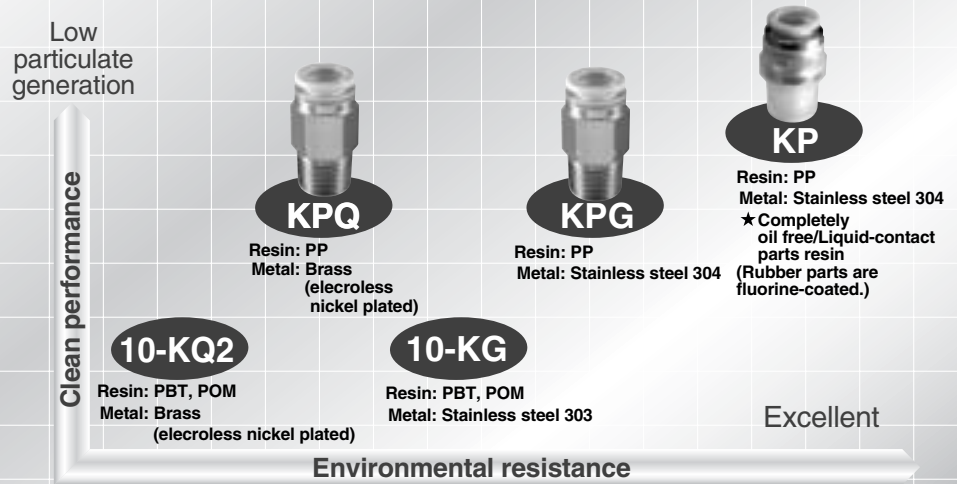

One-touch fittings (for drive system air piping)

Series **KPQ/KPG**

Brass
(electroless nickel plated)

Stainless steel 304

● Resin parts are P.P. (Polypropylene)

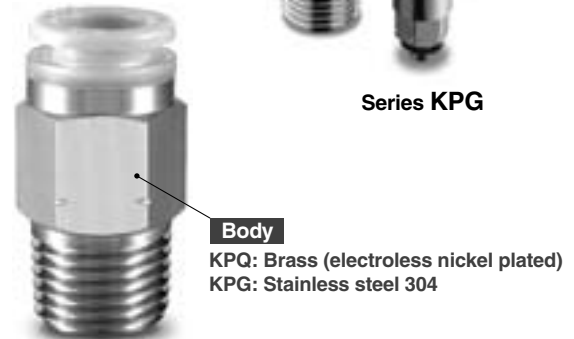
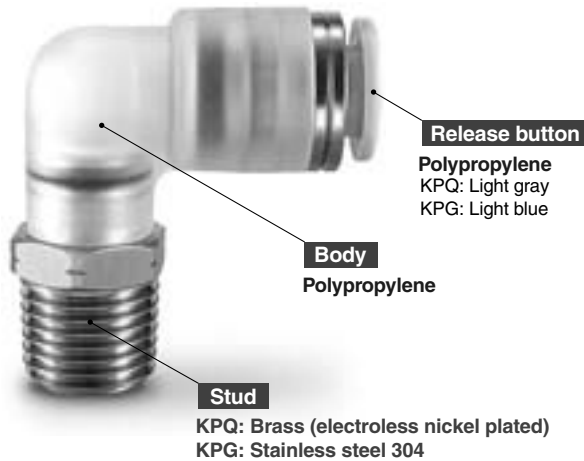

Male connector

■ Drive air piping system

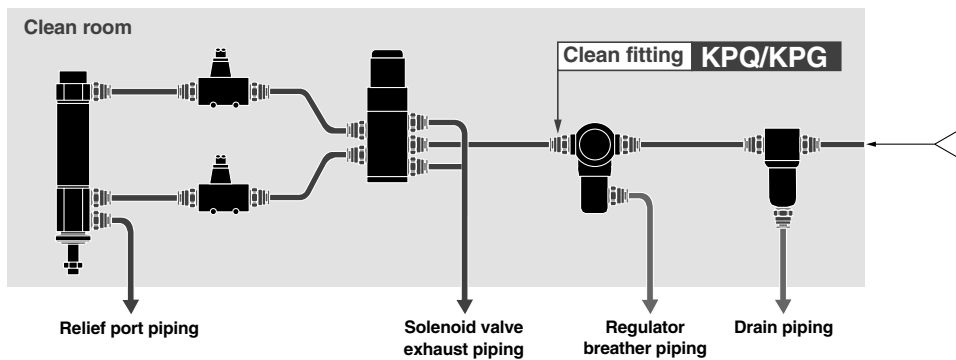

- K
- M
- H
- KK
- D
- MS
- LQ
- MQR
- T

Clean One-touch Fittings For Blowing Series *KP*



⚠ Caution

Series KP is a line of special One-touch fittings for use in clean room blowing and washing lines.

Please consult with SMC regarding other types of applications.

Seal material: The durability of EPDM with respect to mineral oils is inferior, which makes it unsuitable for piping in general pneumatic equipment.



Made to Order
(Refer to page 281 for details.)

Particulate Generation Grade Classifications

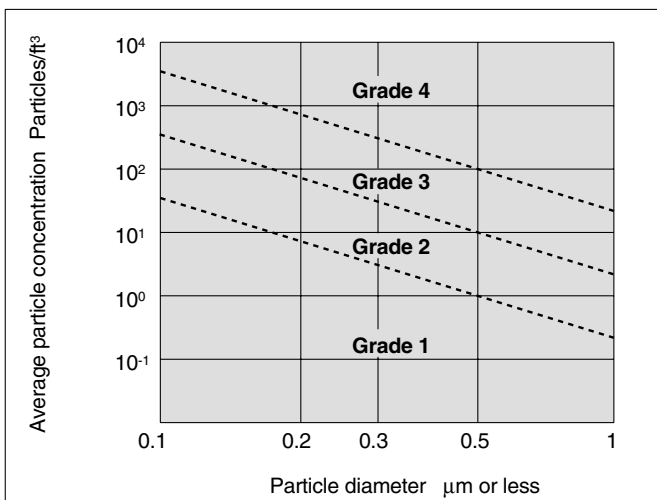

Note) Refer to Features 2 in CAT. E02-23A, "SMC Pneumatic Clean Series" for details.

Applicable Tubing

Tubing material	PFA, Polyolefin Soft polyolefin, Polyurethane
Tubing O.D.	ø4, ø6, ø8, ø10, ø12

Note 1) FEP, nylon and soft nylon tubing, and tubing not compatible with the clean series can also be used. However, the degree of clean performance will be reduced.

Note 2) Due to the softness of polyurethane tubing, it may fold when being inserted. Hold the end of the tubing and insert it all the way in.

Specifications

Particulate generation grade	Grade 1 Note 1)
Fluid	Air/Nitrogen gas/Water (pure water) Note 2)
Maximum operating pressure (20°C)	1 MPa Note 3)
Operating vacuum pressure	-100 kPa {10 Torr}
Proof pressure (20°C)	3 MPa
Ambient and fluid temperature	-20°C to 80°C
Threads	JIS B0203 (Taper thread for piping)

Note 1) Refer to particulate generation grade classifications.

Note 2) The surge pressure must be under the maximum operating pressure.

Note 3) The maximum operating pressure is the value at 20°C. Refer to the operating pressure curve for other temperatures.

Note 4) Do not use the fittings with a leak tester or for vacuum retention because they are not guaranteed for zero leakage.

Relation between Operating Temperature and Maximum Operating Pressure

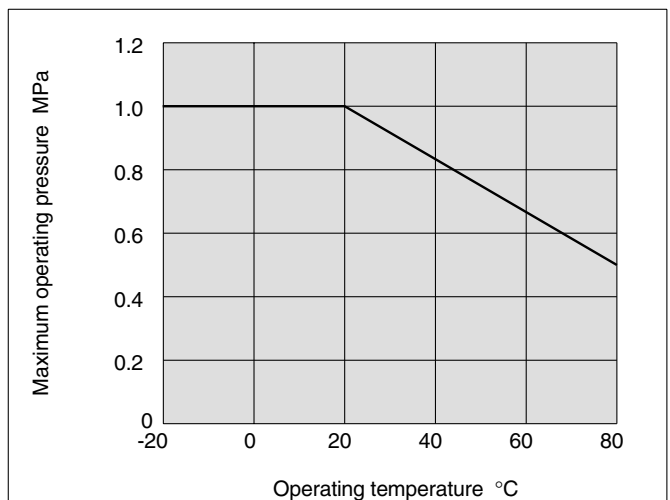

How to Order

Clean One-touch fittings (for blowing)

Model

H	Male connector, Straight union
L	Union elbow, Male elbow
T	Male branch tee, Union tee
Y	Male run tee
U	Male branch, Union "Y"
R	Plug-in reducer

Applicable tubing O.D.

04	ø4
06	ø6
08	ø8
10	ø10
12	ø12

Port size/Applicable tubing O.D.

Thread connection	01	R 1/8
	02	R 1/4
	03	R 3/8
	04	R 1/2
Tubing (rod) connection	00	Same dia. tubing
	04	ø4
	06	ø6
	08	ø8
	10	ø10
	12	ø12
		Different dia. tubing (plug-in reducer)

Made to Order
X53 With pipe tape

Applicable fitting size

04	ø4
06	ø6
08	ø8
10	ø10
12	ø12

Plug

Clean One-touch fittings

Examples: KP H 06 - 01 - [] KP P 08

Construction

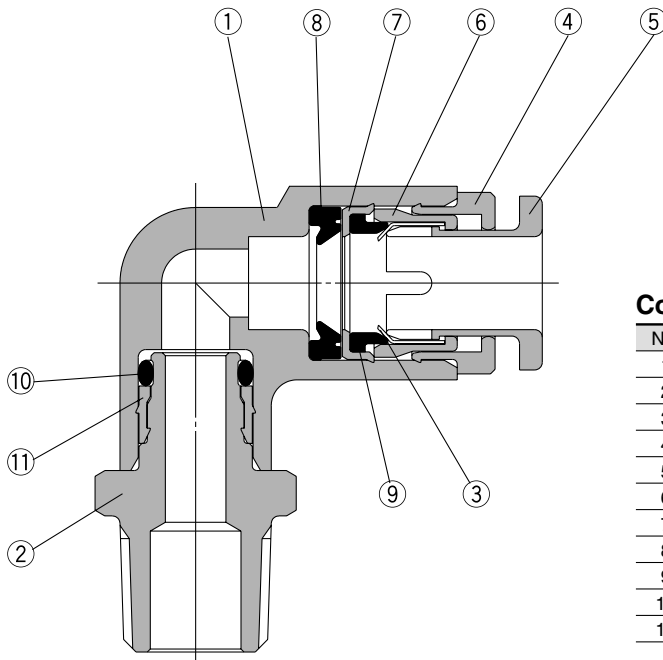

Component Parts

No.	Description	Material
1	Body	PP
2	Stud	PP
3	Chuck	Stainless steel 304
4	Guide	Stainless steel 304
5	Release button	PP (color: light green)
6	Collet	PP
7	Stopper	Stainless steel 304
8	Seal	EPDM (Fluorine-coated)
9	Bumper	EPDM (Fluorine-coated)
10	O-ring	EPDM (Fluorine-coated)
11	Drive bushing	Stainless steel 304

Series KP

Dimensions

Male Connector: KPH



Applicable tubing O.D. mm	Connection thread R	Model	H (width across flats)	L	A*	M	Effective area mm ²		Mass g
							TPH	TPS	
4	1/8	KPH04-01	12	24.4	20.5	17	4	4	3
	1/4	KPH04-02			18.5				4
6	1/8	KPH06-01	14	24.9	21	18.5	10	10	4
	1/4	KPH06-02		25.4	19.5				5
8	1/8	KPH08-01	17	31.3	27.5	20.5	26	18	6
	1/4	KPH08-02		29.3	23.5				7
10	1/4	KPH10-02	19	36.5	31	23	41	29	10
	3/8	KPH10-03		32	26				11
12	3/8	KPH12-03	22	33	27	24	58	46	12
	1/2	KPH12-04		33.5	26				13

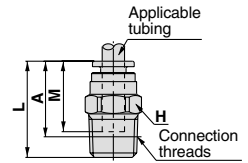

* Reference dimension for R threads after installation

Male Elbow: KPL



Applicable tubing O.D. mm	Connection thread R	Model	H (width across flats)	Note 1) ϕD_1	ϕD_2	L ₁	L ₂	A*	M	Effective area mm ²		Mass g
										TPH	TPS	
4	1/8	KPL04-01	12	10.4	10	19.7	23.2	24.5	17	3.5	3.5	4
	1/4	KPL04-02										14
6	1/8	KPL06-01	12	12.8	10	21.8	24.4	27	18.5	9	9	5
	1/4	KPL06-02										14
8	1/8	KPL08-01	14	15.2	12	25.3	26.6	30	20.5	22	15	8
	1/4	KPL08-02										14
10	1/4	KPL10-02	17	18.5	17	28.4	32.1	35.5	23	35	25	13
	3/8	KPL10-03										17
12	3/8	KPL12-03	22	20.9	22	30.4	34.3	38.5	24	50	40	15
	1/2	KPL12-04										22

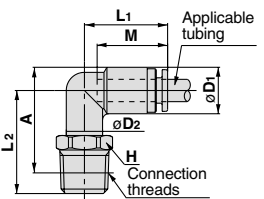

* Reference dimension for R threads after installation Note 1) ϕD_1 indicates the maximum diameter.

Male Branch Tee: KPT



Applicable tubing O.D. mm	Connection thread R	Model	H (width across flats)	Note 1) ϕD_1	ϕD_2	L ₁	L ₂	A*	M	Effective area mm ²		Mass g
										TPH	TPS	
4	1/8	KPT04-01	12	10.4	10	19.7	23.2	24.5	17	4.1	4.1	6
	1/4	KPT04-02										14
6	1/8	KPT06-01	12	12.8	10	21.8	24.4	27	18.5	11	11	8
	1/4	KPT06-02										14
8	1/8	KPT08-01	14	15.2	12	25.3	26.6	30	20.5	26.3	18.2	12
	1/4	KPT08-02										14
10	1/4	KPT10-02	17	18.5	17	28.4	32.1	35.5	23	40.8	29	20
	3/8	KPT10-03										17
12	3/8	KPT12-03	22	20.9	22	30.4	34.3	38.5	24	57.2	45.2	24
	1/2	KPT12-04										22

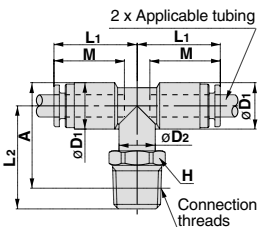

* Reference dimension for R threads after installation Note 1) ϕD_1 indicates the maximum diameter.

Male Run Tee: KPY



Applicable tubing O.D. mm	Connection thread R	Model	H (width across flats)	Note 1) ϕD_1	ϕD_2	L ₁	L ₂	A*	M	Effective area mm ²		Mass g
										TPH	TPS	
4	1/8	KPY04-01	12	10.4	10	19.7	23.2	39	17	7.5	7.5	6
	1/4	KPY04-02										14
6	1/8	KPY06-01	12	12.8	10	21.8	24.4	42	18.5	11	11	8
	1/4	KPY06-02										14
8	1/8	KPY08-01	14	15.2	12	25.3	26.6	48	20.5	21	21	12
	1/4	KPY08-02										14
10	1/4	KPY10-02	17	18.5	17	28.4	32.1	55	23	45	45	19
	3/8	KPY10-03										17
12	3/8	KPY12-03	22	20.9	22	30.4	34.3	58.5	24	57	57	21
	1/2	KPY12-04										22

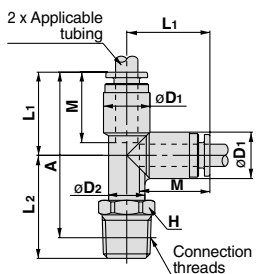

*Reference dimension for R threads after installation Note 1) ϕD_1 indicates the maximum diameter.

Male Branch "Y": KPU



Applicable tubing O.D. mm	Connection thread R	Model	H (width across flats)	Note 1) ϕD	L	P	A*	M	Effective area mm ²		Mass g
									TPH	TPS	
4	1/8	KPU04-01	12	10.4	10.4	10.4	40.5	17	7.5	7.5	7
	1/4	KPU04-02									14
6	1/8	KPU06-01	14	12.8	12.8	12.8	44.5	18.5	18	18	9
	1/4	KPU06-02									14
8	1/8	KPU08-01	17	15.2	15.2	15.2	51.5	20.5	26	26	15
	1/4	KPU08-02									17
10	1/4	KPU10-02	19	18.5	18.5	18.5	58	23	45	45	23
	3/8	KPU10-03									19
12	3/8	KPU12-03	22	20.9	20.9	20.9	62.5	24	70	70	29
	1/2	KPU12-04									22

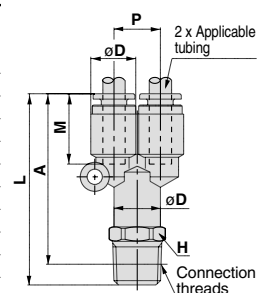

* Reference dimension for R threads after installation Note 1) ϕD indicates the maximum diameter.

Dimensions

Straight Union: KPH



Applicable tubing O.D. mm	Model	Note 1) ϕD	L	M	Effective area mm ²		Mass g
					TPH	TPS	
4	KPH04-00	10.4	35.4	17	4	4	4
6	KPH06-00	12.8	37.6	18.5	10	10	6
8	KPH08-00	15.2	42.4	20.5	26	18	10
10	KPH10-00	18.5	46.6	23	41	29	15
12	KPH12-00	20.9	48.6	24	58	46	18

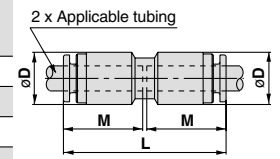

Note 1) ϕD indicates the maximum diameter.

Elbow: KPL



Applicable tubing O.D. mm	Model	Note 1) ϕD	L	Q	M	Effective area mm ²		Mass g
						TPH	TPS	
4	KPL04-00	10.4	19.7	4.5	17	3.5	3.5	3
6	KPL06-00	12.8	21.8	5.3	18.5	9	9	7
8	KPL08-00	15.2	25.3	6	20.5	22	15	11
10	KPL10-00	18.5	28.4	6.8	23	35	25	16
12	KPL12-00	20.9	30.4	7.5	24	50	40	20

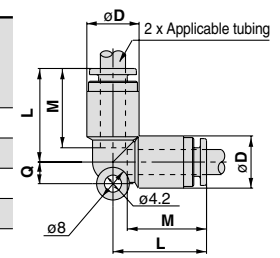

Note 1) ϕD indicates the maximum diameter.

Union Tee: KPT



Applicable tubing O.D. mm	Model	Note 1) ϕD	L	Q	M	Effective area mm ²		Mass g
						TPH	TPS	
4	KPT04-00	10.4	19.7	4.5	17	4	4	7
6	KPT06-00	12.8	21.8	5.3	18.5	10	10	9
8	KPT08-00	15.2	25.3	6	20.5	26	18	16
10	KPT10-00	18.5	28.4	6.8	23	41	29	25
12	KPT12-00	20.9	30.4	7.5	24	58	46	29

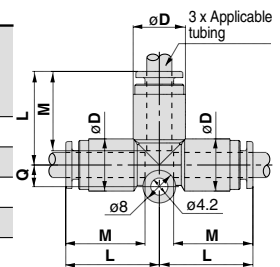

Note 1) ϕD indicates the maximum diameter.

Union "Y": KPU



Applicable tubing O.D. mm	Model	Note 1) ϕD	L ₁	L ₂	P	Q	M	Effective area mm ²		Mass g
								TPH	TPS	
4	KPU04-00	10.4	36.8	19.6	10.4	9.7	17	4	4	7
6	KPU06-00	12.8	40.1	21.8	12.8	11.7	18.5	10	10	10
8	KPU08-00	15.2	46.7	26.5	15.2	13.7	20.5	26	18	17
10	KPU10-00	18.5	52	29.7	18.5	16.1	23	41	29	26
12	KPU12-00	20.9	55.2	31.9	20.9	18.1	24	58	46	32

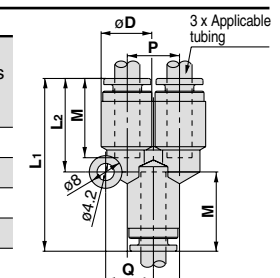

Note 1) ϕD indicates the maximum diameter.

Plug-in Reducer: KPR



Applicable tubing O.D. mm	Applicable fitting size ϕd	Model	Note 1) ϕD	L	A	M	Effective area mm ²		Mass g
							TPH	TPS	
4	6	KPR04-06	10.4	38.4	19.1	17	4	4	3
	8	KPR04-08		40.9	19.2				
6	8	KPR06-08	12.8	41.5	19.8	18.5	10	10	4
		KPR06-10		44	20.2				
8	10	KPR08-10	15.2	46	22.2	20.5	26	18	5
		KPR08-12		47					
10	12	KPR10-12	18.5	49.5	24.7	23	41	29	9

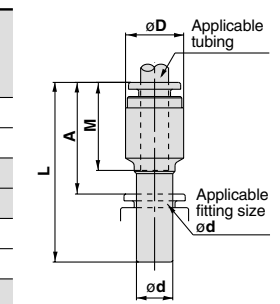

Note 1) ϕD indicates the maximum diameter.

Plug: KPP



Applicable fitting size ϕd	Model	ϕD	L	A	Mass g
4	KPP-04	6	32	13.8	0.4
6	KPP-06	8	35	15.7	0.7
8	KPP-08	10	39	17.3	1.1
10	KPP-10	12	43	19.2	1.7
12	KPP-12	14	45.5	20.7	2.5

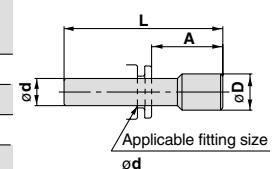

Clean One-touch Fittings For Driving Air Piping Series **KPQ/KPG**



Series KPQ
Brass (electroless nickel plated)
Release button: Light gray



Series KPG
Stainless steel 304
Release button: Light blue

Applicable Tubing

Tubing material	PFA, Polyurethane
Tubing O.D.	ø4, ø6, ø8, ø10, ø12

FEP, nylon and soft nylon tubing, and tubing not compatible with the clean series can also be used. However, the degree of clean performance will be reduced.

Specifications

Particulate generation grade	Grade 1 Note 1)
Fluid	Air
Maximum operating pressure (20°C)	1 MPa Note 2)
Operating vacuum pressure	-100 kPa
Proof pressure (20°C)	3 MPa
Ambient and fluid temperature	-5°C to 60°C
Threads	JIS B0203 (Taper thread for piping)
Oil	Fluorine-based grease

Note 1) Refer to particulate generation grade classifications

This falls outside of the grade because fluorine grease is applied to the internal seal materials.

Note 2) The maximum operating pressure is the value at 20°C. Refer to the operating pressure curve for other temperatures.

Note 3) Do not use the fittings with a leak tester or for vacuum retention because they are not guaranteed for zero leakage.



Made to Order
(Refer to page 285 for details.)

Particulate Generation Grade Classifications

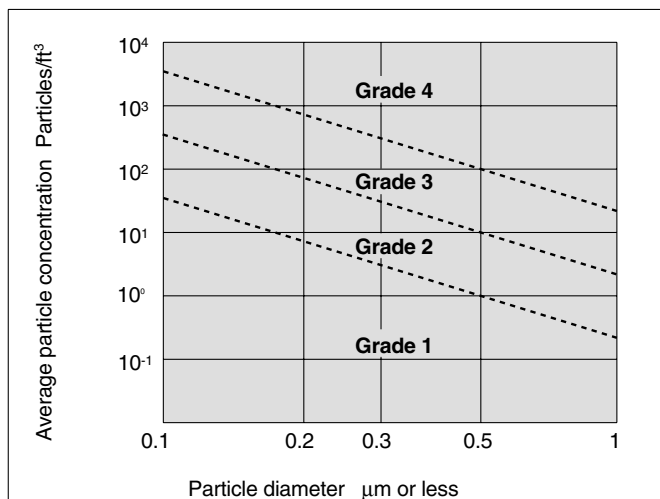

Note) Refer to Features 2 in CAT. E02-23A, "SMC Pneumatic Clean Series" for details.

Relation between Operating Temperature and Maximum Operating Pressure

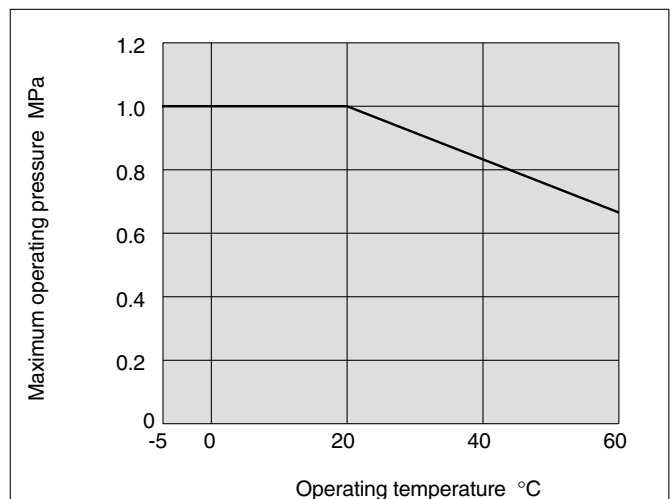

How to Order

KP Q H 06 - 01 -

• Clean One-touch fittings

• Specifications

Symbol	Specifications (metal part materials)
Q	Brass (electroless nickel plated)
G	Stainless steel 304

• Model

H	Male connector, Straight union
L	Union elbow, Male elbow
T	Male branch tee, Union tee
Y	Male run tee
U	Male branch, Union "Y"
R	Plug-in reducer

• Applicable tubing O.D.

04	ø4
06	ø6
08	ø8
10	ø10
12	ø12

Made to Order

X53	With pipe tape Grease-free
X193 Note 1)	Rubber material: EPDM (Fluorine-coated) Gasket: M-5G3 (Stainless steel 316, Special FKM) Note 2) With release bushing, Guide color: Natural

Note 1) Series KPG: Compatible with products with threads only
Note 2) M5 thread

• Port size/Applicable tubing O.D.

Thread connection		
M5		M5 x 0.8
01		R 1/8
02		R 1/4
03		R 3/8
04		R 1/2
Tubing (rod) connection	00	Same dia. tubing
	04	ø4
	06	ø6
	08	ø8
	10	ø10
12	ø12	Different dia. tubing (plug-in reducer)

KP P 08

• Applicable fitting size

04	ø4
06	ø6
08	ø8
10	ø10
12	ø12

• Plug

• Clean One-touch fittings

K

M

H

KK

D

MS

LQ

MQR

T

Construction

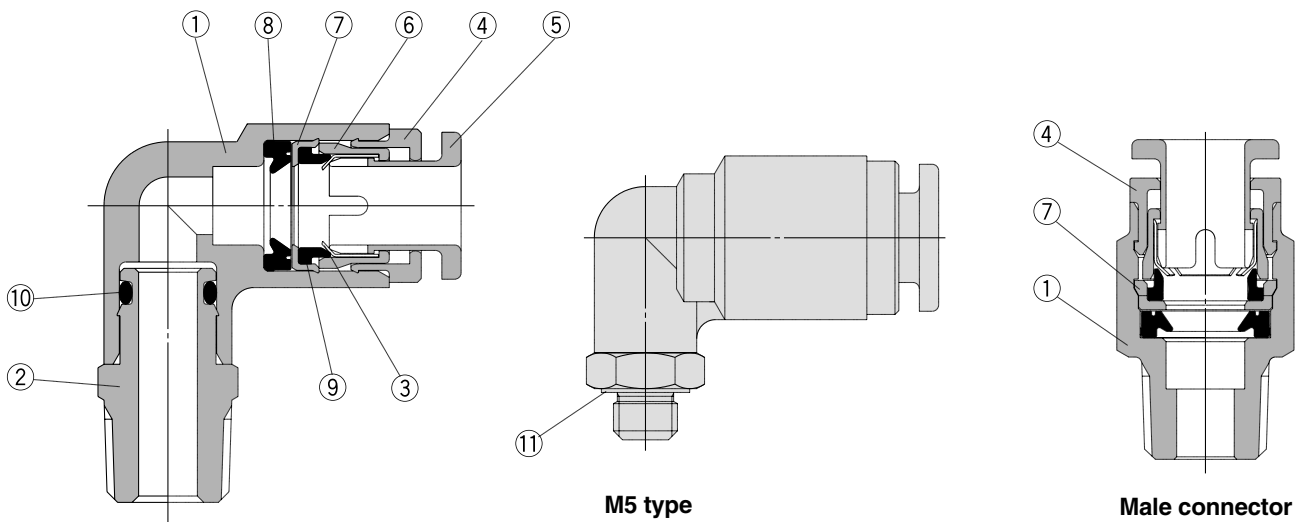

Component Parts

No.	Description	Material	
		Series KPQ	Series KPG
1	Body <input type="checkbox"/> With male connector	PP	
		C3604 (electroless nickel plated)	Stainless steel 304
2	Stud	C3604 (electroless nickel plated)	Stainless steel 304
3	Chuck	Stainless steel 304	
4	Guide <input type="checkbox"/> With male connector	C3604 (electroless nickel plated)	
		PP	
5	Release button	PP (color: light gray)	PP (color: light blue)
6	Collet	PP	
7	Stopper <input type="checkbox"/> With male connector	Stainless steel 304	
		PP	
8	Seal	NBR	
9	Bumper	NBR	
10	O-ring	NBR	
11	Gasket	Stainless steel 304, NBR	

Series KPQ/KPG

Dimensions

Male Connector: KPQH, KPGH

(M5)



(R)



Applicable tubing O.D. mm	Connection thread R M	Model		H (width across flats)	øD	L	A*	M	Effective area mm ²		Mass g
									TPH	TPS	
4	M5 x 0.8	KPQH04-M5	—	8	10	24.4	21.5	17	4	4	4
		—	KPGH04-M5			24.9					
	1/8	KPQH04-01	KPGH04-01	10	—	23.5	18.5				
6	M5 x 0.8	KPQH04-02	KPGH04-02	14	—	21.4	16	18.5	10	10	5
		—	KPGH06-M5	8	12	25.3	22				
	1/8	KPQH06-01	KPGH06-01	12	—	23.7	18.5				
8	M5 x 0.8	KPQH06-02	KPGH06-02	14	—	24.6	19	20.5	26	18	14
		—	KPGH08-01	12	—	30.7	25.5				
	1/4	KPQH08-01	KPGH08-01	14	—	29.1	23.5				
10	M5 x 0.8	KPQH08-02	KPGH08-02	14	—	30.7	25.5	23	41	29	24
		—	KPGH10-02	17	—	36.1	30.5				
	3/8	KPQH10-03	KPGH10-03	17	—	30.9	25.5				
12	M5 x 0.8	KPQH12-03	KPGH12-03	19	—	32	26.5	24	58	46	23
		1/2	KPQH12-04	KPGH12-04	22	—	32.2				

* Reference dimension for R threads after installation

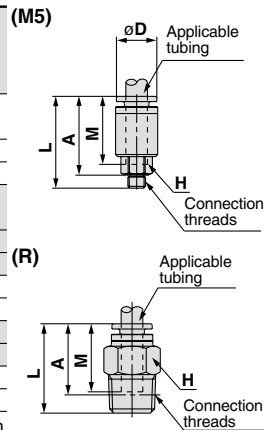

Male Elbow: KPQL, KPGL

(M5)



(R)



Applicable tubing O.D. mm	Connection thread R M	Model		H (width across flats)	Note 1) øD ₁	øD ₂	L ₁	L ₂	A*	M	Effective area mm ²		Mass g	
											TPH	TPS		
4	M5 x 0.8	KPQL04-M5	KPGL04-M5	8	10.4	8	19.7	15.3	17	17	4	4	4	
		—	KPGL04-01	10										21.1
	1/4	KPQL04-02	KPGL04-02	14										—
6	M5 x 0.8	KPQL06-M5	KPGL06-M5	8	12.8	8	21.8	15.8	18.5	18.5	10	10	6	
		—	KPGL06-01	10										22.3
	1/4	KPQL06-02	KPGL06-02	14										—
8	M5 x 0.8	KPQL08-01	KPGL08-01	12	15.2	12	25.3	23.5	26	20.5	26	18	13	
		—	KPGL08-02	14										27.9
	1/4	KPQL08-02	KPGL08-02	14										—
10	M5 x 0.8	KPQL10-02	KPGL10-02	14	18.5	17	28.4	29.4	33	23	41	29	26	
		—	KPGL10-03	17										30.8
	3/8	KPQL12-03	KPGL12-03	17										—
12	M5 x 0.8	KPQL12-03	KPGL12-03	19	20.9	17	30.4	32	37	24	58	46	38	
		1/2	KPQL12-04	KPGL12-04										22

* Reference dimension for R threads after installation Note 1) øD₁ indicates the maximum diameter.

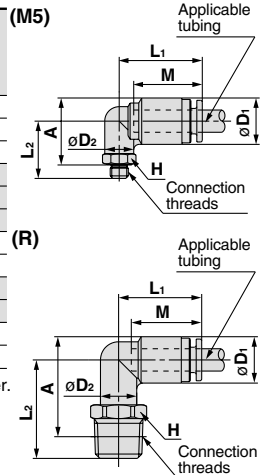

Union Tee: KPQT, KPGT

(M5)



(R)



Applicable tubing O.D. mm	Connection thread R M	Model		H (width across flats)	Note 1) øD ₁	øD ₂	L ₁	L ₂	A*	M	Effective area mm ²		Mass g		
											TPH	TPS			
4	M5 x 0.8	KPQT04-M5	KPGT04-M5	8	10.4	8	19.7	15.3	17	17	4	4	6		
		—	KPQT04-01	KPGT04-01										10	21.1
	1/4	KPQT04-02	KPGT04-02	14										—	25.5
6	M5 x 0.8	KPQT06-M5	KPGT06-M5	8	12.8	8	21.8	15.8	18.5	18.5	10	10	7		
		—	KPQT06-01	KPGT06-01										10	22.3
	1/4	KPQT06-02	KPGT06-02	14										—	26.7
8	M5 x 0.8	KPQT08-01	KPGT08-01	12	15.2	12	25.3	23.5	26	20.5	26	18	14		
		—	KPQT08-02	KPGT08-02										14	27.9
	1/4	KPQT08-02	KPGT08-02	14										—	29.4
10	M5 x 0.8	KPQT10-02	KPGT10-02	14	18.5	17	28.4	29.4	33	23	41	29	29		
		—	KPQT10-03	KPGT10-03										17	30.8
	3/8	KPQT12-03	KPGT12-03	17										—	32
12	M5 x 0.8	KPQT12-03	KPGT12-03	19	20.9	17	30.4	32	37	24	58	46	41		
		1/2	KPQT12-04	KPGT12-04										22	—

* Reference dimension for R threads after installation Note 1) øD₁ indicates the maximum diameter.

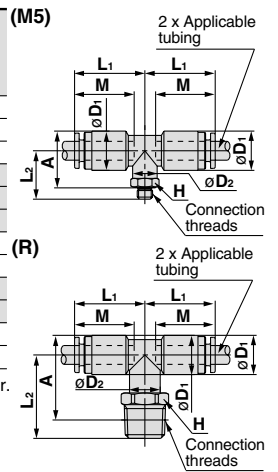

Dimensions

Male Run Tee: KPQY, KPGY

(M5)



(R)



Applicable tubing O.D. mm	Connection thread R M	Model		H (width across flats)	Note 1) ϕD_1	ϕD_2	L1	L2	A*	M	Effective area mm ²		Mass g		
		TPH	TPS												
4	M5 x 0.8	KPQY04-M5	KPGY04-M5	8	10.4	8	19.7	15.3	31.5	17	4	4	6		
	1/8	KPQY04-01	KPGY04-01	10		10							21.1	35.5	13
	1/4	KPQY04-02	KPGY04-02	14		10							25.5	39.5	19
6	M5 x 0.8	KPQY06-M5	KPGY06-M5	8	12.8	8	21.8	15.8	34	18.5	10	10	7		
	1/8	KPQY06-01	KPGY06-01	10		10							22.3	39	14
	1/4	KPQY06-02	KPGY06-02	14		10							26.7	43	20
8	1/8	KPQY08-01	KPGY08-01	12	15.2	12	25.3	23.5	43.5	20.5	26	18	14		
	1/4	KPQY08-02	KPGY08-02	14									17	27.9	47.5
10	1/4	KPQY10-02	KPGY10-02	17	18.5	17	28.4	29.4	52.5	23	41	29	29		
	3/8	KPQY10-03	KPGY10-03										30.8	54	39
	3/8	KPQY12-03	KPGY12-03										32	57	41
12	1/2	KPQY12-04	KPGY12-04	22	20.9	17	30.4	36.2	59.5	24	58	46	68		

* Reference dimension for R threads after installation Note 1) ϕD_1 indicates the maximum diameter.

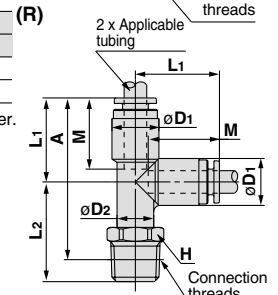
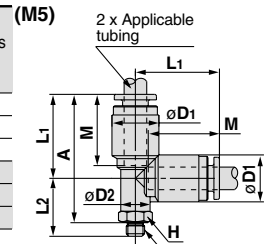

Male Branch: KPQU, KPGU

(M5)



(R)



Applicable tubing O.D. mm	Connection thread R M	Model		H (width across flats)	Note 1) ϕD	L	P	A*	M	Effective area mm ²		Mass g	
		TPH	TPS										
4	M5 x 0.8	KPQU04-M5	KPGU04-M5	11	10.4	40.7	10.4	37	17	4	4	10	
	1/8	KPQU04-01	KPGU04-01	11		42.3						11	
	1/4	KPQU04-02	KPGU04-02	14		46.7						20	
6	M5 x 0.8	KPQU06-M5	KPGU06-M5	13	12.8	43.9	12.8	40.5	18.5	10	10	12	
	1/8	KPQU06-01	KPGU06-01	13		45.5						11	
	1/4	KPQU06-02	KPGU06-02	14		49.9						21	
8	1/8	KPQU08-01	KPGU08-01	17	15.2	53.6	15.2	48.5	20.5	26	18	15	
	1/4	KPQU08-02	KPGU08-02			59.1						53.5	23
10	1/4	KPQU10-02	KPGU10-02	19	18.5	62.3	18.5	57	23	41	29	30	
	3/8	KPQU10-03	KPGU10-03			59.2						54	40
	3/8	KPQU12-03	KPGU12-03			64.9						59.5	40
12	1/2	KPQU12-04	KPGU12-04	22	20.9	69.5	20.9	62.5	24	58	46	65	

* Reference dimension for R threads after installation Note 1) ϕD indicates the maximum diameter.

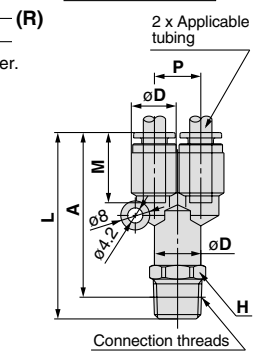
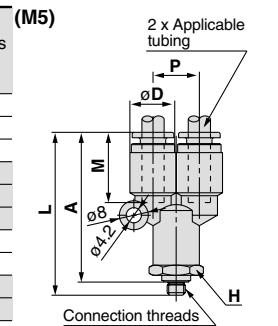

Straight Union: KPQH, KPGH



Applicable tubing O.D. mm	Model		Note 1) ϕD	L	M	Effective area mm ²		Mass g
	TPH	TPS						
4	KPQH04-00	KPGH04-00	10.4	35.4	17	4	4	4
6	KPQH06-00	KPGH06-00	12.8	37.6	18.5	10	10	6
8	KPQH08-00	KPGH08-00	15.2	42.4	20.5	26	18	10
10	KPQH10-00	KPGH10-00	18.5	46.6	23	41	29	15
12	KPQH12-00	KPGH12-00	20.9	48.6	24	58	46	18

Note 1) ϕD indicates the maximum diameter.

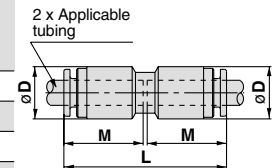

Series KPQ/KPG

Elbow: KPQL, KPGL



Applicable tubing O.D. mm	Model		Note 1) ϕD	L	Q	M	Effective area mm ²		Mass g
							TPH	TPS	
4	KPQL04-00	KPGL04-00	10.4	19.7	4.5	17	3.5	3.5	3
6	KPQL06-00	KPGL06-00	12.8	21.8	5.3	18.5	9	9	7
8	KPQL08-00	KPGL08-00	15.2	25.3	6	20.5	22	15	11
10	KPQL10-00	KPGL10-00	18.5	28.4	6.8	23	35	25	16
12	KPQL12-00	KPGL12-00	20.9	30.4	7.5	24	50	40	20

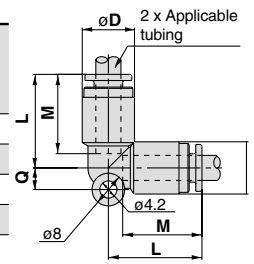

Note 1) ϕD indicates the maximum diameter.

Union Tee: KPQT, KPGT



Applicable tubing O.D. mm	Model		Note 1) ϕD	L	Q	M	Effective area mm ²		Mass g
							TPH	TPS	
4	KPQT04-00	KPGT04-00	10.4	19.7	4.5	17	4	4	7
6	KPQT06-00	KPGT06-00	12.8	21.8	5.3	18.5	10	10	9
8	KPQT08-00	KPGT08-00	15.2	25.3	6	20.5	26	18	16
10	KPQT10-00	KPGT10-00	18.5	28.4	6.8	23	41	29	25
12	KPQT12-00	KPGT12-00	20.9	30.4	7.5	24	58	46	29

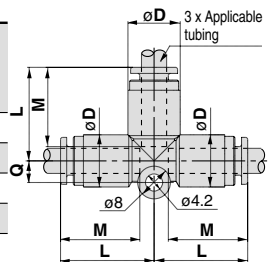

Note 1) ϕD indicates the maximum diameter.

Union "Y": KPQU, KPGU



Applicable tubing O.D. mm	Model		Note 1) ϕD	L ₁	L ₂	P	Q	M	Effective area mm ²		Mass g
									TPH	TPS	
4	KPQU04-00	KPGU04-00	10.4	36.8	19.6	10.4	9.7	17	4	4	7
6	KPQU06-00	KPGU06-00	12.8	40.1	21.8	12.8	11.7	18.5	10	10	10
8	KPQU08-00	KPGU08-00	15.2	46.7	26.5	15.2	13.7	20.5	26	18	17
10	KPQU10-00	KPGU10-00	18.5	52	29.7	18.5	16.1	23	41	29	26
12	KPQU12-00	KPGU12-00	20.9	55.2	31.9	20.9	18.1	24	58	46	32

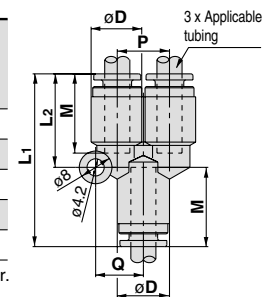

Note 1) ϕD indicates the maximum diameter.

Plug-in Reducer: KPQR, KPGR



Applicable tubing O.D. mm	Applicable fitting size ϕd	Model		Note 1) ϕD	L	A	M	Effective area mm ²		Mass g
								TPH	TPS	
4	6	KPQR04-06	KPGR04-06	10.4	38.4	19.1	17	4	4	3
	8	KPQR04-08	KPGR04-08		40.9	19.2				
6	8	KPQR06-08	KPGR06-08	12.8	41.5	19.8	18.5	10	10	4
	10	KPQR06-10	KPGR06-10		44	20.2				
8	10	KPQR08-10	KPGR08-10	15.2	46	22.2	20.5	26	18	5
	12	KPQR08-12	KPGR08-12		47					
10	12	KPQR10-12	KPGR10-12	18.5	49.5	24.7	23	41	29	9

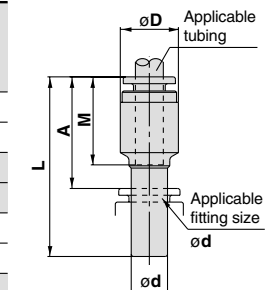

Note 1) ϕD indicates the maximum diameter.

Plug: KPP



Applicable fitting size ϕd	Model	ϕD	L	A	Mass g
4	KPP-04	6	32	13.8	0.4
6	KPP-06	8	35	15.7	0.7
8	KPP-08	10	39	17.3	1.1
10	KPP-10	12	43	19.2	1.7
12	KPP-12	14	45.5	20.7	2.5

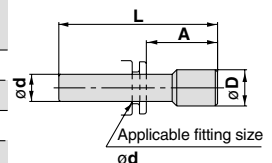

* The plug is common for series KPQ, KPG and KP.



Series KP/KPQ/KPG

Specific Product Precautions 1

Be sure to read before handling.

Refer to front matters 58 and 59 for Safety Instructions and pages 13 to 16 for Fittings and Tubing Precautions.

Selection

⚠ Caution

1. Please consult with SMC regarding fluids other than air, water and nitrogen gas.

Handling

⚠ Caution

1. Store away from direct sunlight at 40°C or less.
2. Open the inner package of double packaging in a clean room or other clean environment.

Installation of Threads

⚠ Caution

Be sure to wrap sealing tape around the taper threads for both resin and metal threads.

If used without sealing tape air leakage can occur.

1. Series KP (with resin thread)

- 1) Wrapping of pipe tape
Wrap the pipe tape 2 to 3 times around the threads, leaving 1.5 to 2 thread ridges exposed at the end of the threads.
- 2) Tightening
After tightening by hand, tighten an additional 2 to 3 turns using a tightening tool.

2. Series KPQ/KPG (with metal thread)

- 1) For M5
After tightening by hand, tighten approximately 1/6 turn further using a tightening tool. Reference values for the tightening torque are 1 to 1.5 N·m. Excessive tightening can cause air leakage due to thread damage or deformation of the gasket, etc. Insufficient tightening can cause loose threads and air leakage, etc.

Installation of Threads

⚠ Caution

2) Taper thread

(1) Wrapping of pipe tape

Wrap the pipe tape 2 to 3 times around the threads, leaving 1 thread ridges exposed at the end of the threads.

- (2) When installing, tighten with the proper torque shown in the table below. As a rule, this corresponds to two or three turns with a tool after tightening by hand.

Connection thread size	Proper tightening torque (N·m)
R 1/8	7 to 9
R 1/4	12 to 14
R 3/8	22 to 24
R 1/2	28 to 30

3. Tightening tools

Tighten with an appropriate wrench using the hexagon wrench flats on the body.

Position the wrench on the base as close as possible to the threads. If the size of the wrench is not suitable for the hexagon wrench flats, the wrench flats may be crushed.

Installation and Removal of Tubing

⚠ Caution

1. Installation of tubing

- 1) Grease is not used due to the Series KP oil-free specifications. For this reason, greater insertion force is required when tubing is installed. In particular, polyurethane tubing may fold when inserted due to its softness. Hold the end of the tubing, and insert it all the way in slowly and securely. Refer to dimension "M" in the dimension drawings for guidance on the insertion depth of tubing.

2. Removal of tubing

- 1) The outside diameter of tubes that have been used at high temperatures or for long periods of time will expand, and in some cases pipe fittings cannot be reattached. Tubes that cannot be attached should be discarded and replaced with new ones.

K

M

H

KK

D

MS

LQ

MQR

T



Series **KP/KPQ/KPG**

Specific Product Precautions 2

Be sure to read before handling.

Refer to front matters 58 and 59 for Safety Instructions and pages 13 to 16 for Fittings and Tubing Precautions.

Operating Environment

Warning

1. Do not use in environments or locations where there is a danger of damage to fittings and tubing.

For fitting and tubing materials, refer to specifications and construction drawings, etc.

2. Provide shade in locations which receive direct sunlight.

Caution

1. Series KP are special One-touch fittings for use on clean blowing and washing lines.

Please consult with SMC regarding other types of applications.

Seal material: The durability of EPDM with respect to mineral oils is inferior, making it unsuitable for piping in general pneumatic equipment.

Use Series KPQ and KPG for piping to general pneumatic equipment.

Maintenance

Caution

1. Tightening of blow fittings (resin taper threads for piping)

Since Series KP taper threads are made of resin, minute leakage may gradually occur due to stress relaxation. Perform periodic inspections, and if leakage is detected correct the problem by further tightening. If additional tightening becomes ineffective, replace the fitting with a new product.

2. Check for the following during regular maintenance, and replace components as necessary.

- a) Scratches, gouges, abrasion, corrosion
- b) Leakage, refer to item 3 regarding taper thread leakage.
- c) Twisting, flattening or distortion of tubing
- d) Hardening, deterioration or softness of tubing

3. Do not repair or patch the replaced tubing or fittings for reuse.

Clean One-touch Fittings For Driving Air Piping Series *KPQ/KPG*



Series KPQ
Brass (electroless nickel plated)
Release button: Light gray



Series KPG
Stainless steel 304
Release button: Light blue



Made to Order
(Refer to page 285 for details.)

Particulate Generation Grade Classifications

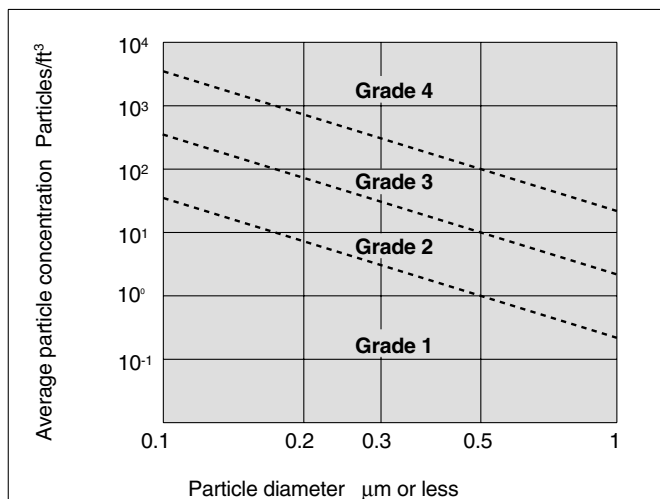

Note) Refer to Features 2 in CAT. E02-23A, "SMC Pneumatic Clean Series" for details.

Relation between Operating Temperature and Maximum Operating Pressure

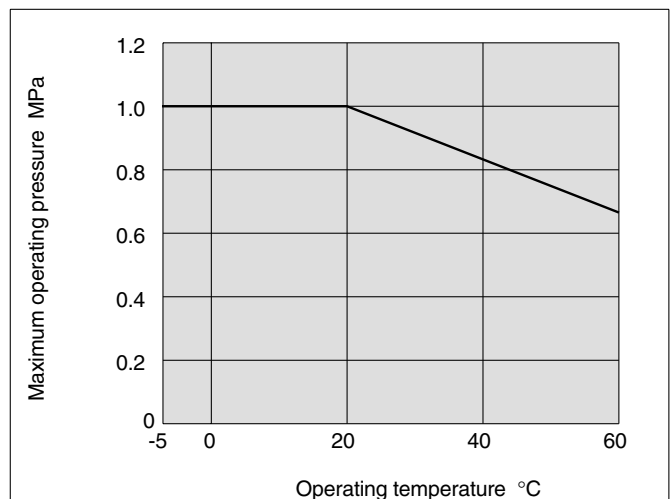

Applicable Tubing

Tubing material	PFA, Polyurethane
Tubing O.D.	ø4, ø6, ø8, ø10, ø12

FEP, nylon and soft nylon tubing, and tubing not compatible with the clean series can also be used. However, the degree of clean performance will be reduced.

Specifications

Particulate generation grade	Grade 1 Note 1)
Fluid	Air
Maximum operating pressure (20°C)	1 MPa Note 2)
Operating vacuum pressure	-100 kPa
Proof pressure (20°C)	3 MPa
Ambient and fluid temperature	-5°C to 60°C
Threads	JIS B0203 (Taper thread for piping)
Oil	Fluorine-based grease

Note 1) Refer to particulate generation grade classifications

This falls outside of the grade because fluorine grease is applied to the internal seal materials.

Note 2) The maximum operating pressure is the value at 20°C. Refer to the operating pressure curve for other temperatures.

Note 3) Do not use the fittings with a leak tester or for vacuum retention because they are not guaranteed for zero leakage.

How to Order

Example Part Number: KP Q H 06 - 01 - []

Specifications

Symbol	Specifications (metal part materials)
Q	Brass (electroless nickel plated)
G	Stainless steel 304

Model

H	Male connector, Straight union
L	Union elbow, Male elbow
T	Male branch tee, Union tee
Y	Male run tee
U	Male branch, Union "Y"
R	Plug-in reducer

Applicable tubing O.D.

04	ø4
06	ø6
08	ø8
10	ø10
12	ø12

Made to Order

X53	With pipe tape Grease-free
X193 Note 1)	Rubber material: EPDM (Fluorine-coated) Gasket: M-5G3 (Stainless steel 316, Special FKM) Note 2) With release bushing, Guide color: Natural

Note 1) Series KPG: Compatible with products with threads only
Note 2) M5 thread

Port size/Applicable tubing O.D.

Thread connection	Port size	Applicable tubing O.D.
M5	M5 x 0.8	
01	R 1/8	
02	R 1/4	
03	R 3/8	
04	R 1/2	
00	Same dia. tubing	
04	ø4	Different dia. tubing (plug-in reducer)
06	ø6	
08	ø8	
10	ø10	
12	ø12	

Applicable fitting size

04	ø4
06	ø6
08	ø8
10	ø10
12	ø12

Plug

Clean One-touch fittings

Available Options: K M H KK D MS LQ MQR T

Construction

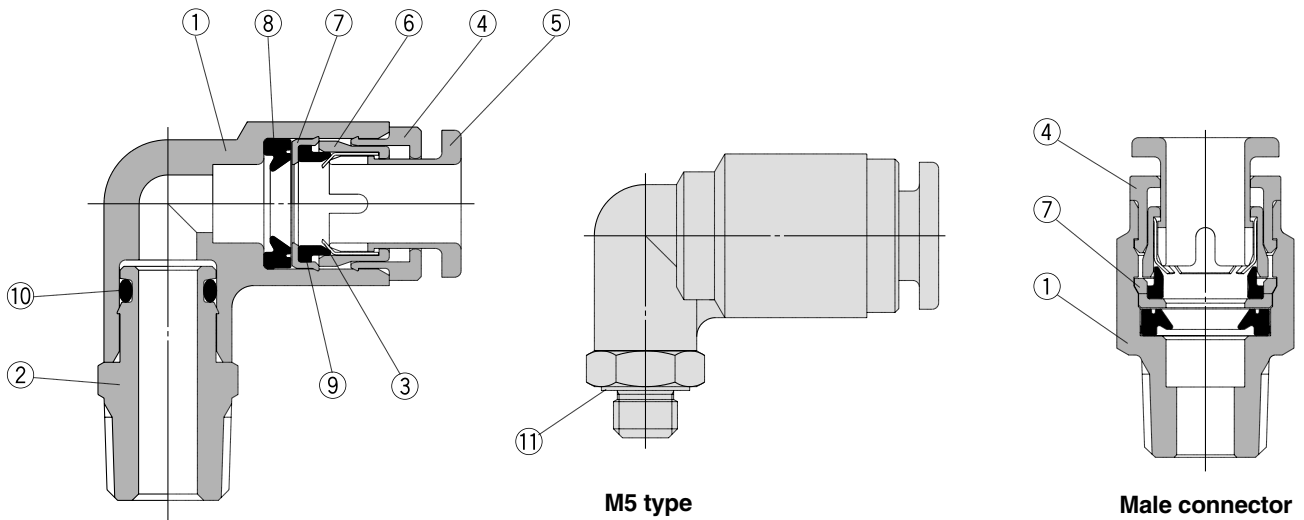

Component Parts

No.	Description	Material	
		Series KPQ	Series KPG
1	Body	PP	
		With male connector	C3604 (electroless nickel plated)
2	Stud	C3604 (electroless nickel plated)	Stainless steel 304
3	Chuck	Stainless steel 304	
4	Guide	C3604 (electroless nickel plated)	Stainless steel 304
		With male connector	PP
5	Release button	PP (color: light gray)	PP (color: light blue)
6	Collet	PP	
7	Stopper	Stainless steel 304	
		With male connector	PP
8	Seal	NBR	
9	Bumper	NBR	
10	O-ring	NBR	
11	Gasket	Stainless steel 304, NBR	

Series KPQ/KPG

Dimensions

Male Connector: KPQH, KPGH

(M5)



(R)



Applicable tubing O.D. mm	Connection thread R M	Model		H (width across flats)	øD	L	A*	M	Effective area mm ²		Mass g
									TPH	TPS	
4	M5 x 0.8	KPQH04-M5	—	8	10	24.4	21.5	17	4	4	4
		—	KPGH04-M5			24.9					
	1/8	KPQH04-01	KPGH04-01	10	—	23.5	18.5				
6	M5 x 0.8	KPQH04-02	KPGH04-02	14	—	21.4	16	18.5	10	10	5
		—	—	8	12	25.3	22				
	1/8	KPQH06-01	KPGH06-01	12	—	23.7	18.5				
8	M5 x 0.8	KPQH06-02	KPGH06-02	14	—	24.6	19	20.5	26	18	14
		—	—	8	12	25.8	22				
	1/8	KPQH08-01	KPGH08-01	12	—	30.7	25.5				
10	M5 x 0.8	KPQH08-02	KPGH08-02	14	—	29.1	23.5	23	41	29	24
		—	—	8	12	36.1	30.5				
	1/4	KPQH10-01	KPGH10-01	17	—	30.9	25.5				
12	M5 x 0.8	KPQH10-02	KPGH10-02	17	—	36.1	30.5	24	58	46	23
		—	—	8	12	32	25				
	3/8	KPQH12-03	KPGH12-03	19	—	32.2	25				

* Reference dimension for R threads after installation

(M5)

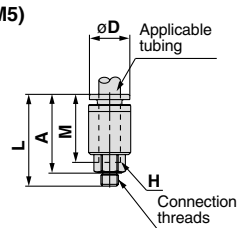

(R)

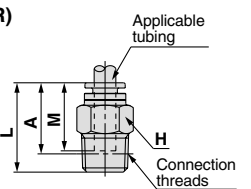

Male Elbow: KPQL, KPGL

(M5)



(R)



Applicable tubing O.D. mm	Connection thread R M	Model		H (width across flats)	Note 1) øD ₁	øD ₂	L ₁	L ₂	A*	M	Effective area mm ²		Mass g
											TPH	TPS	
4	M5 x 0.8	KPQL04-M5	KPGL04-M5	8	10.4	8	19.7	15.3	17	17	4	4	4
		—	—	8									
	1/8	KPQL04-01	KPGL04-01	10	—	25.5	25						
6	M5 x 0.8	KPQL04-02	KPGL04-02	14	12.8	10	21.8	15.8	18.5	18.5	10	10	6
		—	—	8									
	1/8	KPQL06-01	KPGL06-01	10	—	26.7	27.5						
8	M5 x 0.8	KPQL06-02	KPGL06-02	14	15.2	12	25.3	23.5	26	20.5	26	18	13
		—	—	8									
	1/8	KPQL08-01	KPGL08-01	12	—	29.4	33						
10	M5 x 0.8	KPQL08-02	KPGL08-02	14	18.5	17	28.4	30.8	34.5	23	41	29	26
		—	—	8									
	1/4	KPQL10-01	KPGL10-01	17	—	32	37						
12	M5 x 0.8	KPQL10-02	KPGL10-02	17	20.9	17	30.4	36.2	39.5	24	58	46	38
		—	—	8									
	3/8	KPQL12-03	KPGL12-03	19	—	36.2	39.5						

* Reference dimension for R threads after installation Note 1) øD₁ indicates the maximum diameter.

(M5)

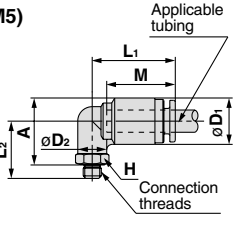

(R)

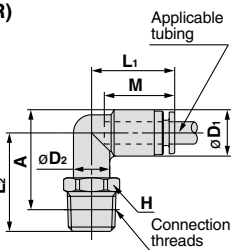

Union Tee: KPQT, KPGT

(M5)



(R)



Applicable tubing O.D. mm	Connection thread R M	Model		H (width across flats)	Note 1) øD ₁	øD ₂	L ₁	L ₂	A*	M	Effective area mm ²		Mass g
											TPH	TPS	
4	M5 x 0.8	KPQT04-M5	KPGT04-M5	8	10.4	8	19.7	15.3	17	17	4	4	6
		—	—	8									
	1/8	KPQT04-01	KPGT04-01	10	—	25.5	25						
6	M5 x 0.8	KPQT04-02	KPGT04-02	14	12.8	10	21.8	15.8	18.5	18.5	10	10	7
		—	—	8									
	1/8	KPQT06-01	KPGT06-01	10	—	26.7	27.5						
8	M5 x 0.8	KPQT06-02	KPGT06-02	14	15.2	12	25.3	23.5	26	20.5	26	18	14
		—	—	8									
	1/8	KPQT08-01	KPGT08-01	12	—	29.4	33						
10	M5 x 0.8	KPQT08-02	KPGT08-02	14	18.5	17	28.4	30.8	34.5	23	41	29	22
		—	—	8									
	1/4	KPQT10-01	KPGT10-01	17	—	32	37						
12	M5 x 0.8	KPQT10-02	KPGT10-02	17	20.9	17	30.4	36.2	39.5	24	58	46	39
		—	—	8									
	3/8	KPQT12-03	KPGT12-03	19	—	36.2	39.5						

* Reference dimension for R threads after installation Note 1) øD₁ indicates the maximum diameter.

(M5)

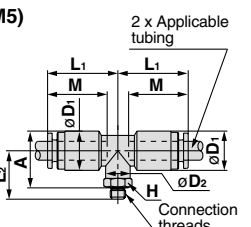

(R)

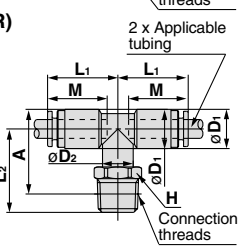

Dimensions

Male Run Tee: KPQY, KPGY

(M5)



(R)



Applicable tubing O.D. mm	Connection thread R M	Model		H (width across flats)	Note 1) ϕD_1	ϕD_2	L1	L2	A*	M	Effective area mm ²		Mass g		
		KPQY	KPGY								TPH	TPS			
4	M5 x 0.8	KPQY04-M5	KPGY04-M5	8	10.4	8	19.7	15.3	31.5	17	4	4	6		
	1/8	KPQY04-01	KPGY04-01	10		10							21.1	35.5	13
	1/4	KPQY04-02	KPGY04-02	14		10							25.5	39.5	19
6	M5 x 0.8	KPQY06-M5	KPGY06-M5	8	12.8	8	21.8	15.8	34	18.5	10	10	7		
	1/8	KPQY06-01	KPGY06-01	10		10							22.3	39	14
	1/4	KPQY06-02	KPGY06-02	14		10							26.7	43	20
8	1/8	KPQY08-01	KPGY08-01	12	15.2	12	25.3	23.5	43.5	20.5	26	18	14		
	1/4	KPQY08-02	KPGY08-02	14									17	27.9	47.5
10	1/4	KPQY10-02	KPGY10-02	17	18.5	17	28.4	29.4	52.5	23	41	29	29		
	3/8	KPQY10-03	KPGY10-03										30.8	54	39
	3/8	KPQY12-03	KPGY12-03										32	57	41
12	1/2	KPQY12-04	KPGY12-04	22	20.9	17	30.4	36.2	59.5	24	58	46	68		

* Reference dimension for R threads after installation Note 1) ϕD_1 indicates the maximum diameter.

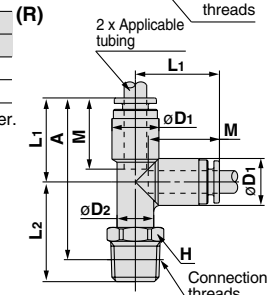
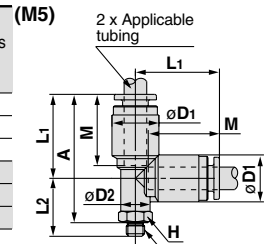

Male Branch: KPQU, KPGU

(M5)



(R)



Applicable tubing O.D. mm	Connection thread R M	Model		H (width across flats)	Note 1) ϕD	L	P	A*	M	Effective area mm ²		Mass g	
		KPQU	KPGU							TPH	TPS		
4	M5 x 0.8	KPQU04-M5	KPGU04-M5	11	10.4	40.7	10.4	37	17	4	4	10	
	1/8	KPQU04-01	KPGU04-01	42.3		41						11	
	1/4	KPQU04-02	KPGU04-02	46.7		41						20	
6	M5 x 0.8	KPQU06-M5	KPGU06-M5	13	12.8	43.9	12.8	40.5	18.5	10	10	12	
	1/8	KPQU06-01	KPGU06-01	45.5		44.5						11	
	1/4	KPQU06-02	KPGU06-02	49.9		44.5						21	
8	1/8	KPQU08-01	KPGU08-01	17	15.2	53.6	15.2	48.5	20.5	26	18	15	
	1/4	KPQU08-02	KPGU08-02	59.1		53.5						23	
10	1/4	KPQU10-02	KPGU10-02	19	18.5	62.3	18.5	57	23	41	29	30	
	3/8	KPQU10-03	KPGU10-03			59.2						54	40
	3/8	KPQU12-03	KPGU12-03			64.9						59.5	40
12	1/2	KPQU12-04	KPGU12-04	22	20.9	20.9	69.5	62.5	24	58	46	65	

* Reference dimension for R threads after installation Note 1) ϕD indicates the maximum diameter.

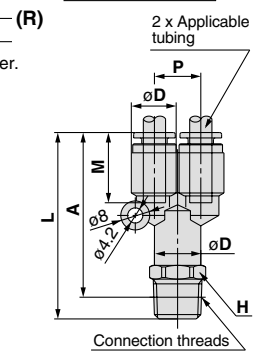
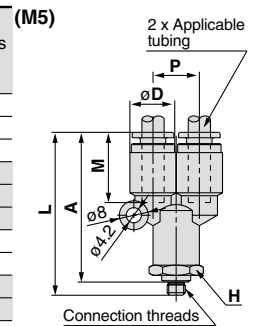

Straight Union: KPQH, KPGH



Applicable tubing O.D. mm	Model		Note 1) ϕD	L	M	Effective area mm ²		Mass g
	KPQH	KPGH				TPH	TPS	
4	KPQH04-00	KPGH04-00	10.4	35.4	17	4	4	4
6	KPQH06-00	KPGH06-00	12.8	37.6	18.5	10	10	6
8	KPQH08-00	KPGH08-00	15.2	42.4	20.5	26	18	10
10	KPQH10-00	KPGH10-00	18.5	46.6	23	41	29	15
12	KPQH12-00	KPGH12-00	20.9	48.6	24	58	46	18

Note 1) ϕD indicates the maximum diameter.

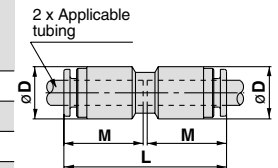

Series KPQ/KPG

Elbow: KPQL, KPGL



Applicable tubing O.D. mm	Model		Note 1) ϕD	L	Q	M	Effective area mm ²		Mass g
							TPH	TPS	
4	KPQL04-00	KPGL04-00	10.4	19.7	4.5	17	3.5	3.5	3
6	KPQL06-00	KPGL06-00	12.8	21.8	5.3	18.5	9	9	7
8	KPQL08-00	KPGL08-00	15.2	25.3	6	20.5	22	15	11
10	KPQL10-00	KPGL10-00	18.5	28.4	6.8	23	35	25	16
12	KPQL12-00	KPGL12-00	20.9	30.4	7.5	24	50	40	20

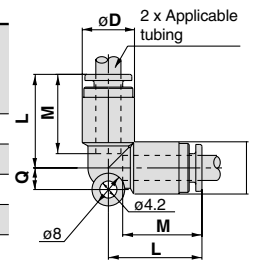

Note 1) ϕD indicates the maximum diameter.

Union Tee: KPQT, KPGT



Applicable tubing O.D. mm	Model		Note 1) ϕD	L	Q	M	Effective area mm ²		Mass g
							TPH	TPS	
4	KPQT04-00	KPGT04-00	10.4	19.7	4.5	17	4	4	7
6	KPQT06-00	KPGT06-00	12.8	21.8	5.3	18.5	10	10	9
8	KPQT08-00	KPGT08-00	15.2	25.3	6	20.5	26	18	16
10	KPQT10-00	KPGT10-00	18.5	28.4	6.8	23	41	29	25
12	KPQT12-00	KPGT12-00	20.9	30.4	7.5	24	58	46	29

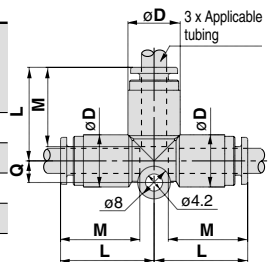

Note 1) ϕD indicates the maximum diameter.

Union "Y": KPQU, KPQU



Applicable tubing O.D. mm	Model		Note 1) ϕD	L ₁	L ₂	P	Q	M	Effective area mm ²		Mass g
									TPH	TPS	
4	KPQU04-00	KPGU04-00	10.4	36.8	19.6	10.4	9.7	17	4	4	7
6	KPQU06-00	KPGU06-00	12.8	40.1	21.8	12.8	11.7	18.5	10	10	10
8	KPQU08-00	KPGU08-00	15.2	46.7	26.5	15.2	13.7	20.5	26	18	17
10	KPQU10-00	KPGU10-00	18.5	52	29.7	18.5	16.1	23	41	29	26
12	KPQU12-00	KPGU12-00	20.9	55.2	31.9	20.9	18.1	24	58	46	32

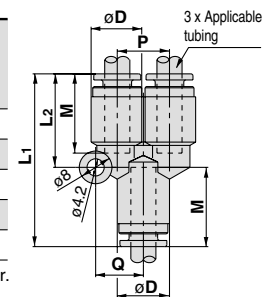

Note 1) ϕD indicates the maximum diameter.

Plug-in Reducer: KPQR, KPGR



Applicable tubing O.D. mm	Applicable fitting size ϕd	Model		Note 1) ϕD	L	A	M	Effective area mm ²		Mass g
								TPH	TPS	
4	6	KPQR04-06	KPGR04-06	10.4	38.4	19.1	17	4	4	3
	8	KPQR04-08	KPGR04-08		40.9	19.2				
6	8	KPQR06-08	KPGR06-08	12.8	41.5	19.8	18.5	10	10	4
	10	KPQR06-10	KPGR06-10		44	20.2				
8	10	KPQR08-10	KPGR08-10	15.2	46	22.2	20.5	26	18	5
	12	KPQR08-12	KPGR08-12		47					
10	12	KPQR10-12	KPGR10-12	18.5	49.5	24.7	23	41	29	9

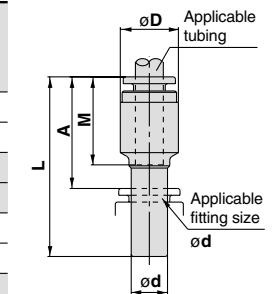

Note 1) ϕD indicates the maximum diameter.

Plug: KPP



Applicable fitting size ϕd	Model	ϕD	L	A	Mass g
4	KPP-04	6	32	13.8	0.4
6	KPP-06	8	35	15.7	0.7
8	KPP-08	10	39	17.3	1.1
10	KPP-10	12	43	19.2	1.7
12	KPP-12	14	45.5	20.7	2.5

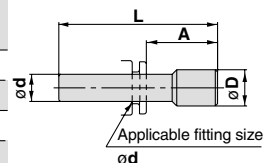

* The plug is common for series KPQ, KPG and KP.



Series KP/KPQ/KPG

Specific Product Precautions 1

Be sure to read before handling.

Refer to front matters 58 and 59 for Safety Instructions and pages 13 to 16 for Fittings and Tubing Precautions.

Selection

⚠ Caution

1. Please consult with SMC regarding fluids other than air, water and nitrogen gas.

Handling

⚠ Caution

1. Store away from direct sunlight at 40°C or less.
2. Open the inner package of double packaging in a clean room or other clean environment.

Installation of Threads

⚠ Caution

Be sure to wrap sealing tape around the taper threads for both resin and metal threads.

If used without sealing tape air leakage can occur.

1. Series KP (with resin thread)

- 1) Wrapping of pipe tape
Wrap the pipe tape 2 to 3 times around the threads, leaving 1.5 to 2 thread ridges exposed at the end of the threads.
- 2) Tightening
After tightening by hand, tighten an additional 2 to 3 turns using a tightening tool.

2. Series KPQ/KPG (with metal thread)

- 1) For M5
After tightening by hand, tighten approximately 1/6 turn further using a tightening tool. Reference values for the tightening torque are 1 to 1.5 N·m. Excessive tightening can cause air leakage due to thread damage or deformation of the gasket, etc. Insufficient tightening can cause loose threads and air leakage, etc.

Installation of Threads

⚠ Caution

2) Taper thread

(1) Wrapping of pipe tape

Wrap the pipe tape 2 to 3 times around the threads, leaving 1 thread ridges exposed at the end of the threads.

- (2) When installing, tighten with the proper torque shown in the table below. As a rule, this corresponds to two or three turns with a tool after tightening by hand.

Connection thread size	Proper tightening torque (N·m)
R 1/8	7 to 9
R 1/4	12 to 14
R 3/8	22 to 24
R 1/2	28 to 30

3. Tightening tools

Tighten with an appropriate wrench using the hexagon wrench flats on the body.

Position the wrench on the base as close as possible to the threads. If the size of the wrench is not suitable for the hexagon wrench flats, the wrench flats may be crushed.

Installation and Removal of Tubing

⚠ Caution

1. Installation of tubing

- 1) Grease is not used due to the Series KP oil-free specifications. For this reason, greater insertion force is required when tubing is installed. In particular, polyurethane tubing may fold when inserted due to its softness. Hold the end of the tubing, and insert it all the way in slowly and securely. Refer to dimension "M" in the dimension drawings for guidance on the insertion depth of tubing.

2. Removal of tubing

- 1) The outside diameter of tubes that have been used at high temperatures or for long periods of time will expand, and in some cases pipe fittings cannot be reattached. Tubes that cannot be attached should be discarded and replaced with new ones.

K

M

H

KK

D

MS

LQ

MQR

T



Series **KP/KPQ/KPG**

Specific Product Precautions 2

Be sure to read before handling.

Refer to front matters 58 and 59 for Safety Instructions and pages 13 to 16 for Fittings and Tubing Precautions.

Operating Environment

Warning

- 1. Do not use in environments or locations where there is a danger of damage to fittings and tubing.**
For fitting and tubing materials, refer to specifications and construction drawings, etc.
- 2. Provide shade in locations which receive direct sunlight.**

Caution

- 1. Series KP are special One-touch fittings for use on clean blowing and washing lines.**
Please consult with SMC regarding other types of applications.

Seal material: The durability of EPDM with respect to mineral oils is inferior, making it unsuitable for piping in general pneumatic equipment.

Use Series KPQ and KPG for piping to general pneumatic equipment.

Maintenance

Caution

- 1. Tightening of blow fittings (resin taper threads for piping)**
Since Series KP taper threads are made of resin, minute leakage may gradually occur due to stress relaxation. Perform periodic inspections, and if leakage is detected correct the problem by further tightening. If additional tightening becomes ineffective, replace the fitting with a new product.
- 2. Check for the following during regular maintenance, and replace components as necessary.**
 - a) Scratches, gouges, abrasion, corrosion
 - b) Leakage, refer to item 3 regarding taper thread leakage.
 - c) Twisting, flattening or distortion of tubing
 - d) Hardening, deterioration or softness of tubing
- 3. Do not repair or patch the replaced tubing or fittings for reuse.**