

# 3 Port Solenoid Valve

## Series VQZ100/200/300

Metal Seal

Rubber Seal

Power consumption: **0.35 w** / **0.9 w**  
 (Standard) (High pressure type, High speed response type)

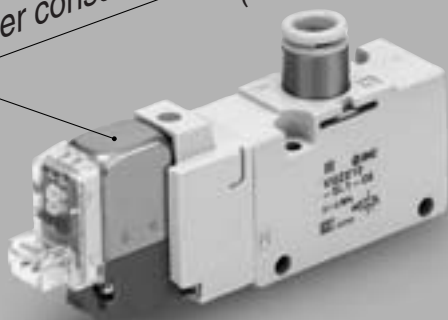

### Compact, High Flow

	Series	Valve width (mm)	Flow characteristics	
			Metal seal C [dm <sup>3</sup> /(s·bar)]	Rubber seal C [dm <sup>3</sup> /(s·bar)]
Body ported	VQZ100	10	—	0.56 (Poppet)
	VQZ200	15	1.3	1.7
	VQZ300	18	2.4	3.0
Base mounted	VQZ100	10	—	1.0 (Poppet)
	VQZ200	15	2.0	3.0
	VQZ300	18	3.2	4.1

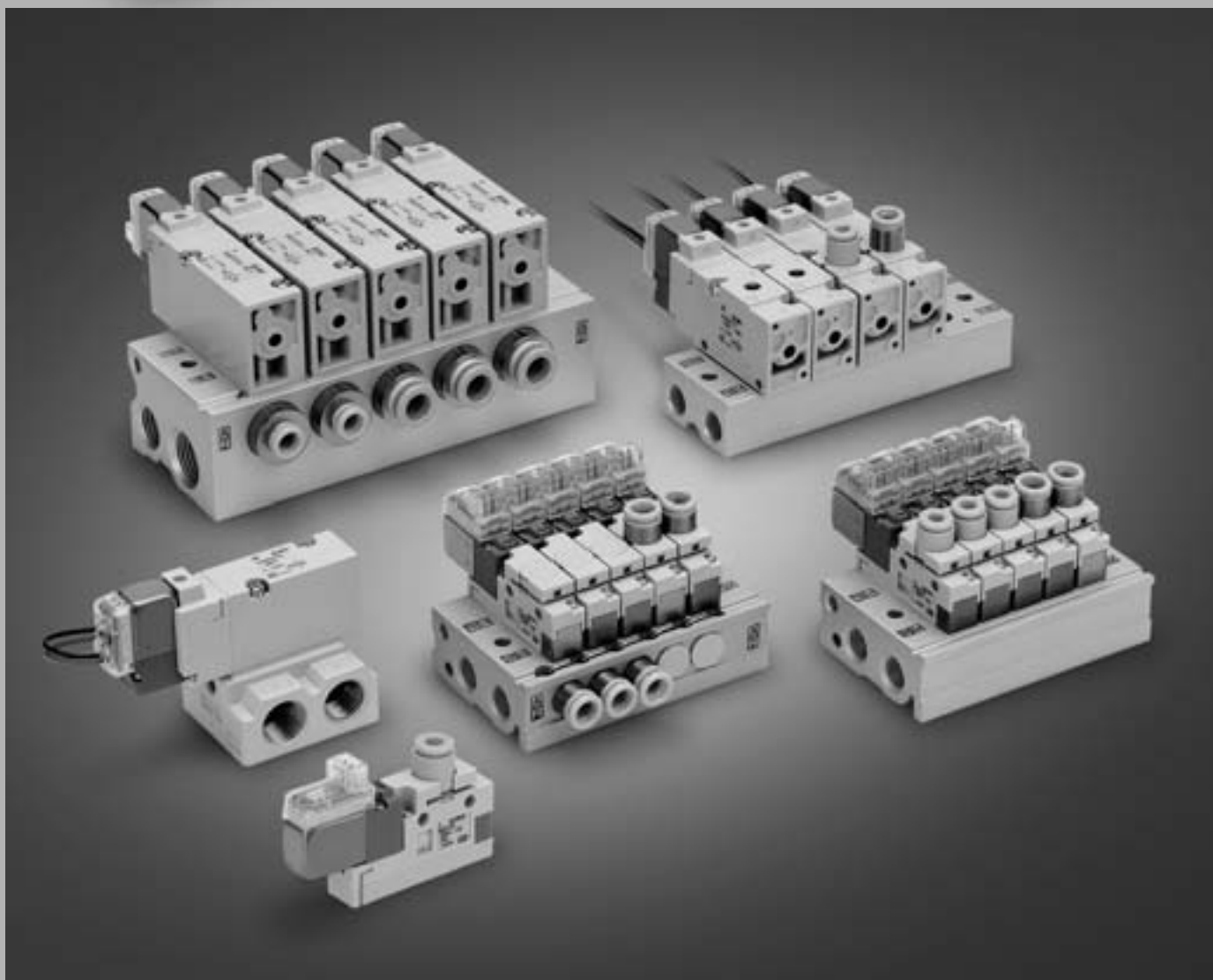

SYJ

VQZ

VP







VG

VP3□

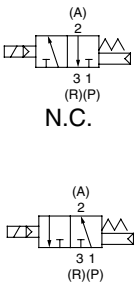
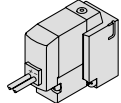
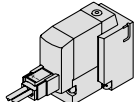
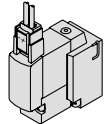
# Metal Seal / Rubber Seal 3 Port Solenoid Valve

## VQZ100/200/300

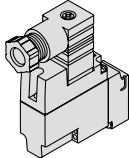
### Solenoid Valve Variations

		Sonic conductance C [dm <sup>3</sup> /(s·bar)]		Type of actuation	Voltage	Electrical entry	Light/surge voltage suppressor	Manual override	
Body ported	3 port	<b>VQZ100</b>  P.1434	Metal —	Rubber (Poppet) 0.56	 (A) 2 3 1 (R)(P) N.C.	(Standard) 12 VDC 24 VDC  (Option) 100 VAC 200 VAC 110 VAC 220 VAC	Grommet (G)   L-type plug connector (L)   M-type plug connector (M) 	With light/surge voltage suppressor  L-type plug connector (L)  M-type plug connector (M)	Non-locking push type (Tool required)
		<b>VQZ200</b>  P.1435	1.3	1.7					
		<b>VQZ300</b>  P.1435	2.4	3.0					
Base mounted	3 port	<b>VQZ100</b>  P.1450	Metal —	Rubber (Poppet) 1.0	(Except VQZ100) N.O.	DIN terminal (Y) 	DIN terminal (YZ) ( Except ) ( VQZ100 )	Locking type (Tool required)	
		<b>VQZ200</b>  P.1451	2.0	3.0					
		<b>VQZ300</b>  P.1451	3.2	4.1					

## Manifold

### Body Ported

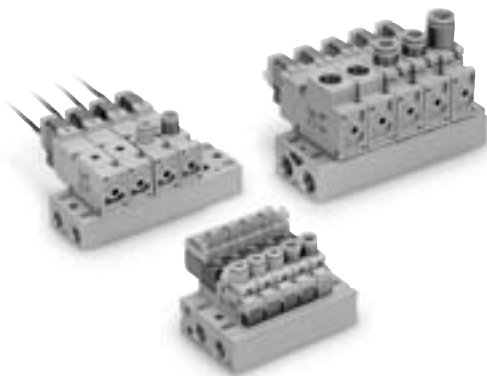

P.1441

Series	Base model	Piping direction	Piping specifications		Applicable solenoid valve	Applicable stations
			1(P), 3(R)	2(A)		
VQZ100	VV3QZ12-□□□	Top	Rc 1/8	C3 (for ø3.2) C4 (for ø4) C6 (for ø6) M5 (M5 thread)	VQZ115	2 to 20 stations
VQZ200	VV3QZ22-□□□	Top	Rc 1/8	C4 (for ø4) C6 (for ø6) M5 (M5 thread)	VQZ2□2	2 to 20 stations
VQZ300	VV3QZ32-□□□	Top	Rc 1/4	C6 (for ø6) C8 (for ø8) C10 (for ø10) Rc 1/4	VQZ3□2	2 to 20 stations

### Base Mounted



P.1457

Series	Base model	Piping direction	Piping specifications		Applicable solenoid valve	Applicable stations
			1(P), 3(R)	2(A)		
VQZ100	VV3QZ15-□□□	Side/top	Rc 1/8	C3 (for ø3.2) C4 (for ø4) C6 (for ø6) M5 (M5 thread)	VQZ115	2 to 20 stations
VQZ200	VV3QZ25-□□□	Side	Rc 1/4	C4 (for ø4) C6 (for ø6) C8 (for ø8) Rc 1/8	VQZ2□5	2 to 20 stations
VQZ300	VV3QZ35-□□□	Side	1(P) port Rc 3/8 3(R) port Rc 1/4	C6 (for ø6) C8 (for ø8) C10 (for ø10) Rc 1/4	VQZ3□5	2 to 20 stations

## Manifold Options

### Body Ported

Blanking plate assembly  
VVQZ100-10A-5  
(for VQZ100)  
VVQZ200-10A-2  
(for VQZ200)  
VVQZ300-10A-2  
(for VQZ300)

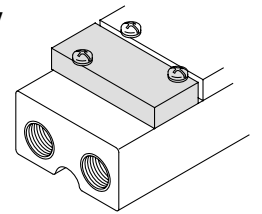

P.1447

Blanking plug

KQ2P-23  
KQ2P-04  
KQ2P-06  
KQ2P-08  
KQ2P-10

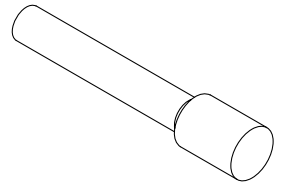

P.1447

DIN rail

AXT100-DR-□

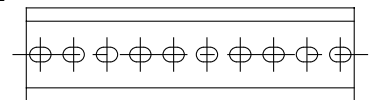

P.1447

Silencer

(for EXH port)

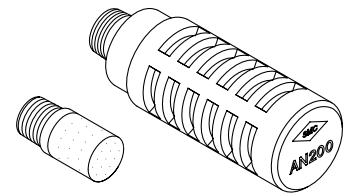

P.1447

### Base Mounted

Blanking plate assembly  
VVQZ100-10A-5  
(for VQZ100)  
VVQZ200-10A-5  
(for VQZ200)  
VVQZ300-10A-5  
(for VQZ300)

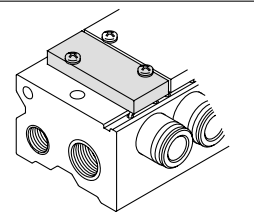

P.1464

Blanking plug

KQ2P-23  
KQ2P-04  
KQ2P-06  
KQ2P-08  
KQ2P-10

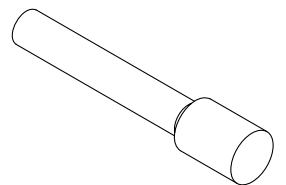

P.1464

DIN rail

AXT100-DR-□

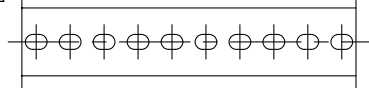

P.1464

Silencer

(for EXH port)

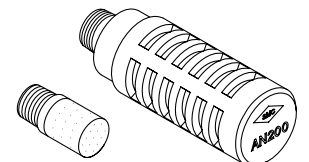

P.1464

Port plug

VVQZ100-CP (for VQZ100)

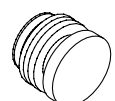

P.1464

SYJ

VQZ

VP

VG

VP3□

# 3 Port Solenoid Valve

## Series VQZ100/200/300

### Single Unit



### VQZ100 / How to Order Valve

VQZ 1 1 5 [ ] - 5 M [ ] 1 - C6 - PR [ ] - [ ]

**Series**  
1 VQZ100 body width 10 mm

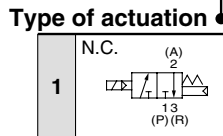

**Body type**

**Function**

Symbol	Specifications	DC (0.35 W) Note 3)	AC (0.9 W) Note 3)
Nil	Standard	○	○
K Note 1)	High pressure type	○	—
R Note 1, 2)	External pilot type	○	○
KR Note 1, 2)	High pressure/External pilot type	○	—



Note 1) Option  
Note 2) For details on external pilot type, refer to page 1448.  
Note 3) For AC specification power consumption, refer to page 1436.

### Caution

Use standard (DC) specification for continuous duty.

**Coil voltage**

1	100 VAC (50/60 Hz)
2	200 VAC (50/60 Hz)
3	110 VAC [115 VAC] (50/60 Hz)
4	220 VAC [230 VAC] (50/60 Hz)
5	24 VDC
6	12 VDC

**CE compliant**

Nil	—
Q	CE compliant

Note) For CE compliant models, DC-type only.

**Option**

Nil: None  
F: With bracket

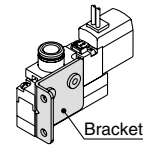

**Port size [2(A) port]**

C3	ø3.2 one-touch fitting
C4	ø4 one-touch fitting
C6	ø6 one-touch fitting
M5	M5 thread (Replaceable type)

Note) For inch size one-touch fittings, refer to page 1448.

**Manual override**

Nil: Non-locking push type  
B: Locking type (Tool required)

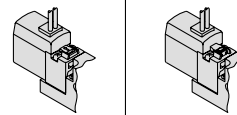

**Electrical entry**

G: Grommet (DC specification)	L: L-type plug connector with lead wire	LO: L-type plug connector without connector	M: M-type plug connector with lead wire	MO: M-type plug connector without connector
	With light/surge voltage suppressor	With light/surge voltage suppressor	With light/surge voltage suppressor	With light/surge voltage suppressor



Note) Standard lead wire length: 300 mm

Note) For applicable one-touch fitting and silencer models for this valve series, refer to page 1470.

## VQZ200/300 / How to Order Valve



Made to Order

(For details, refer to page 1436 and 1467.)

VQZ **2** **1** **2** **5** **M** **1** - **C6** - -

### Series

<b>2</b>	VQZ200 body width 15 mm
<b>3</b>	VQZ300 body width 18 mm

### Type of actuation

<b>1</b>	N.C.	(A) 2	Metal seal
	(R) (P)	3 1	
<b>2</b>	N.O.	(A) 2	Metal seal
	(R) (P)	3 1	
<b>3</b>	N.C.	(A) 2	Rubber seal
	(R) (P)	3 1	
<b>4</b>	N.O.	(A) 2	Rubber seal
	(R) (P)	3 1	

### Body type

<b>2</b>	Body ported
----------	-------------

### Function

Symbol	Specifications	DC	AC
<b>Nil</b>	Standard	(0.35 W) ○	Note 3) ○
<b>B</b> Note 1)	High speed response type	(0.9 W) ○	—
<b>K</b> Note 1)	High pressure type (Metal seal type only)	(0.9 W) ○	—
<b>R</b> Note 1, 2)	External pilot type	○	○
<b>BR</b> Note 1, 2)	High speed response/External pilot type	(0.9 W) ○	—
<b>KR</b> Note 1, 2)	High pressure/External pilot type (Metal seal type only)	(0.9 W) ○	—



Note 1) Option  
Note 2) For details on external pilot type, refer to page 1448.

Note 3) For AC specification power consumption, refer to page 1436.

### Caution

Use standard (DC) specification for continuous duty.

### Coil voltage

<b>1</b>	100 VAC (50/60 Hz)
<b>2</b>	200 VAC (50/60 Hz)
<b>3</b>	110 VAC [115 VAC] (50/60 Hz)
<b>4</b>	220 VAC [230 VAC] (50/60 Hz)
<b>5</b>	24 VDC
<b>6</b>	12 VDC

Note) For applicable one-touch fitting and silencer models for this valve series, refer to back page 1470.

### IP65 compliant

<b>Nil</b>	—
<b>W</b> Note)	Compliant

Note) VQZ200/300 DIN terminal rubber seal only (except external pilot). For details on IP65 enclosure, refer to page 1448.

### CE compliant

<b>Nil</b>	—
<b>Q</b>	CE compliant

Note) AC-type models that are CE compliant have DIN terminals only.

### Option

**Nil:** None  
**F:** With bracket

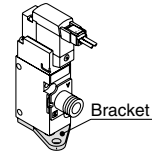

### Port size [2(A) port]

Symbol	Port size	VQZ200	VQZ300
<b>C4</b>	ø4 one-touch fitting	○	—
<b>C6</b>	ø6 one-touch fitting	○	○
<b>C8</b>	ø8 one-touch fitting	—	○
<b>C10</b>	ø10 one-touch fitting	—	○
<b>M5</b>	M5 thread	○	—
<b>02</b>	Rc 1/4	—	○

Note) For inch size one-touch fittings and option thread type, refer to page 1448.

### Manual override

**Nil:** Non-locking push type (Tool required)  
**B:** Locking type (Tool required)

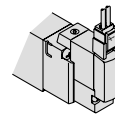
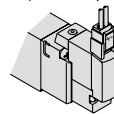

### Electrical entry

<b>G:</b> Grommet (DC specification)	<b>L:</b> L-type plug connector with lead wire	<b>LO:</b> L-type plug connector without connector	<b>M:</b> M-type plug connector with lead wire	<b>MO:</b> M-type plug connector without connector
	With light/surge voltage suppressor 	With light/surge voltage suppressor 	With light/surge voltage suppressor 	With light/surge voltage suppressor 
<b>Y:</b> DIN terminal 	<b>YO:</b> DIN terminal without connector 	<b>YZ:</b> DIN terminal 	<b>YOS:</b> DIN terminal (Note 2) without connector (DC specification) 	<b>YS:</b> DIN terminal (Note 2) without connector (DC specification) 
		With light/surge voltage suppressor 	With surge voltage suppressor 	With surge voltage suppressor 



Note 1) Standard lead wire length: 300 mm

Note 2) For AC voltage valves there is no "S" option. It is already built-in to the rectifier circuit.

SYJ

VQZ

VP

VG

VP3□

# Series VQZ100/200/300

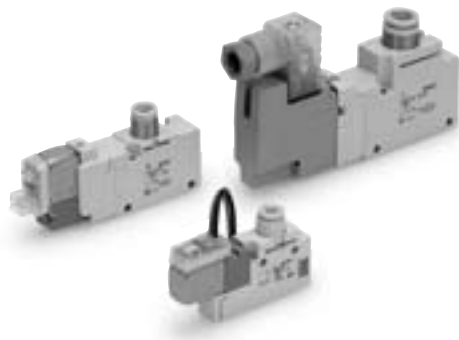

## Specifications

Valve construction	Metal seal	Rubber seal	VQZ100 (Poppet seal)
Fluid	Air, Inert gas		
Max. operating pressure (MPa)	0.7 (High pressure type: 1.0)	0.7	0.7 (High pressure type: 1.0)
Min. operating pressure (MPa)	0.1	0.15	0.15
Ambient and fluid temperature (°C)	-10 to 50 (No freezing)		
Max. operating frequency (Hz)	20	5	20
Pilot exhaust method	Individual exhaust		Common exhaust
Lubrication	Not required		
Manual override	Push type, Locking type (Tool required)		
Mounting orientation	Free		
Impact/Vibration resistance (m/s <sup>2</sup> ) <sup>Note 1)</sup>	150/30		
Enclosure*	Dustproof (DIN terminal: IP65 <sup>Note 2)</sup> )		



\* Based on IEC60529

Note 1) Impact resistance: No malfunction occurred when it is tested with a drop tester in the axial direction and at the right angles to the main valve and armature in both energized and de-energized states every once for each condition. (Value in the initial state)

Vibration resistance: No malfunction occurred in one sweep test between 45 and 2000 Hz. Test was performed to axis and right angle directions of the main valve and armature when pilot signal is ON and OFF. (Value in the initial state)

Note 2) When IP65 compliant DIN terminals are selected: VQZ<sub>3</sub>□2□-□Y□□W1-□□

## Solenoid Specifications

Electrical entry	Grommet (G) L-type plug connector (L)		M-type plug connector (M) DIN terminal (Y)	
	G, L, M		Y	
Coil rated voltage (V)	DC	24, 12		
	AC 50/60 Hz	100, 110, 200, 220*		
Allowable voltage fluctuation	±10% of rated voltage*			
Power consumption (W)	DC	Standard	0.35 [(With light: 0.4 (DIN terminal with light: 0.45)]	
		High speed response, high pressure	0.9 [(With light: 0.95 (DIN terminal with light: 1.0)]	
Apparent power (VA)*	AC	100 V	0.78 (With light: 0.81)	0.78 (With light: 0.87)
		110 V [115 V]	0.86 (With light: 0.89) [0.94 (With light: 0.97)]	0.86 (With light: 0.87) [0.94 (With light: 1.07)]
		200 V	1.18 (With light: 1.22)	1.15 (With light: 1.30)
		220 V [230 V]	1.30 (With light: 1.34) [1.42 (With light: 1.46)]	1.27 (With light: 1.46) [1.39 (With light: 1.60)]
Surge voltage suppressor	Varistor			
Indicator light	LED (Neon light when AC with DIN terminal)			



\* In common between 110 VAC and 115 VAC, and between 220 VAC and 230 VAC.

\* For 115 VAC and 230 VAC, the allowable voltage is -15% to +5% of rated voltage.

## Options

High speed response type
High pressure type (Metal seal type only)
External pilot type*

\* For details on external pilot type, refer to page 1448.



**Made to Order**  
(For details, refer to page 1467.)

Symbol	Description
X30	Pilot valve common exhaust
X90	Main valve fluoro-rubber
X113	All fluoro-rubber

## Flow Characteristics

Series	Valve construction	Model		Flow characteristics						Response time (ms) <sup>Note 1)</sup>				Note 2) Mass (g)
				1→2 (P→A)			2→3 (A→R)			Standard: 0.35 W	High speed response: 0.9 W	High pressure: 0.9 W	AC	
				C [dm <sup>3</sup> /(s·bar)]	b	Cv	C [dm <sup>3</sup> /(s·bar)]	b	Cv					
VQZ100	N.C. valve	Poppet	VQZ115	0.59	0.44	0.17	0.56	0.30	0.14	10 or less	—	13 or less	22 or less	24
VQZ200	N.C. valve	Metal seal	VQZ212	1.2	0.21	0.30	1.3	0.24	0.33	22 or less	14 or less	18 or less	34 or less	57
		Rubber seal	VQZ232	1.6	0.33	0.39	1.7	0.37	0.45	22 or less	15 or less	—	36 or less	
	N.O. valve	Metal seal	VQZ222	1.2	0.25	0.31	1.3	0.20	0.31	22 or less	14 or less	18 or less	34 or less	
		Rubber seal	VQZ242	1.6	0.36	0.40	1.7	0.36	0.45	22 or less	15 or less	—	36 or less	
VQZ300	N.C. valve	Metal seal	VQZ312	2.7	0.18	0.62	2.4	0.28	0.56	22 or less	17 or less	22 or less	34 or less	93
		Rubber seal	VQZ332	3.5	0.34	0.87	3.0	0.33	0.72	33 or less	25 or less	—	57 or less	
	N.O. valve	Metal seal	VQZ322	2.6	0.21	0.59	2.2	0.16	0.49	22 or less	17 or less	22 or less	34 or less	
		Rubber seal	VQZ342	3.5	0.38	0.88	2.9	0.27	0.69	33 or less	25 or less	—	57 or less	



Note 1) Based on JIS B 8375-1981 (Supply pressure: 0.5 MPa; with light/surge voltage suppressor: clean air)  
Response time values will change depending on pressure and air quality.

Note 2) Mass for threaded connection

## Construction

### VQZ100 Poppet type

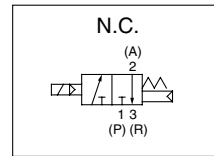
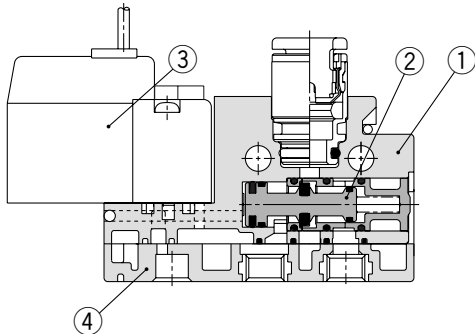

### Component Parts

No.	Description	Material	Note
1	Body	Resin	
2	Spool valve	Aluminum/HNBR	
3	Pilot valve assembly	—	
4	P, R port	Resin/Aluminum	VQZ100-12A (Standard) VQZ100-12B (External pilot type)

### VQZ200/300 Metal seal type

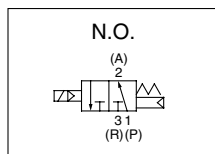
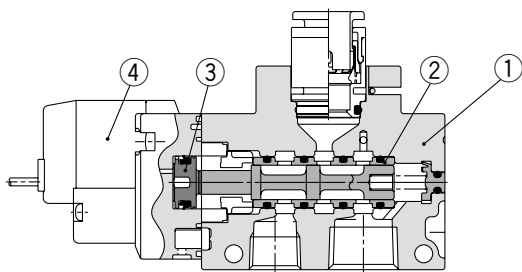
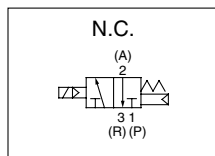
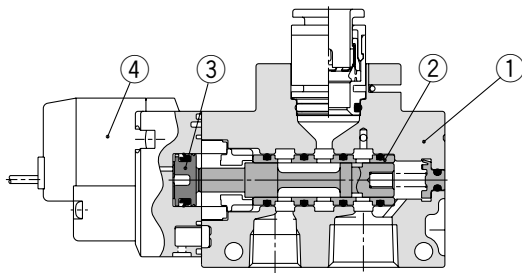

### Rubber seal type

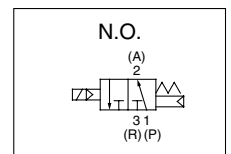
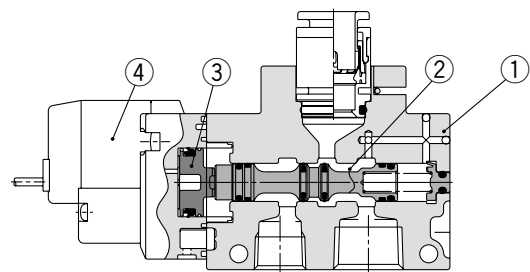
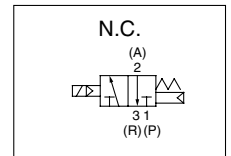
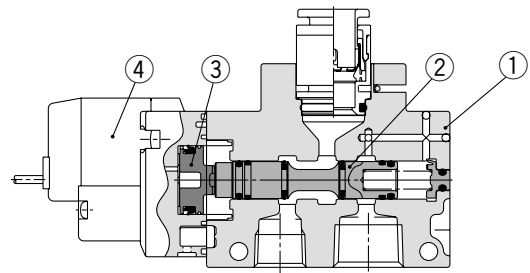

### Component Parts

No.	Description	Material	Note
1	Body	Aluminum die-casted	
2	Spool, Sleeve	Stainless steel	Metal seal
	Spool valve	Aluminum/HNBR	Rubber seal
3	Piston	Resin	
4	Pilot valve assembly	—	

Note) For "How to Order Pilot Valve Assembly", refer to page 1449.

SYJ

VQZ

VP

VG

VP3□

# Series VQZ100/200/300

## Dimensions: VQZ100

### Single Unit

Grommet (G): VQZ115□-□G□1-C3, C4, C6-PR

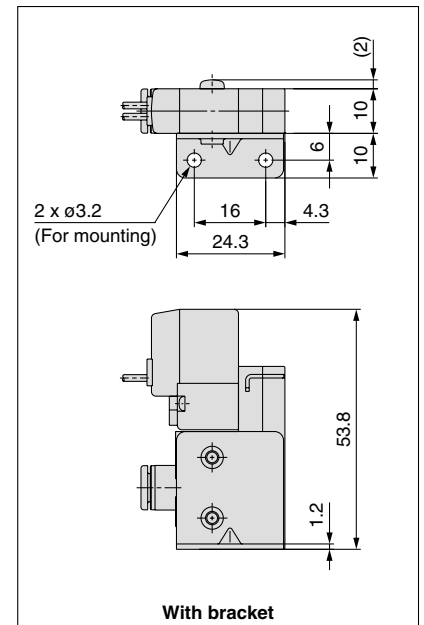
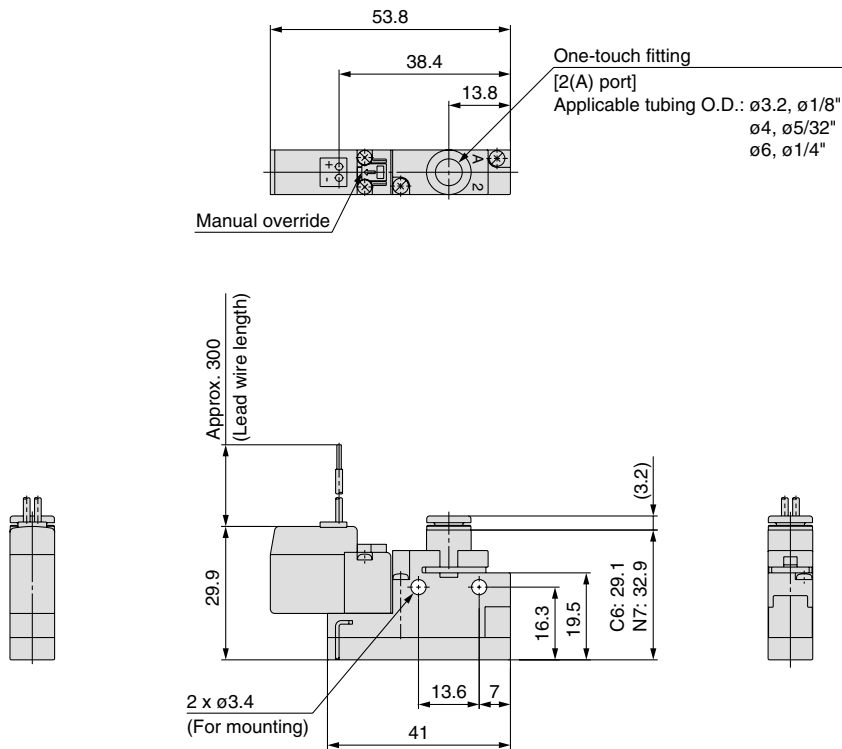

Note) For bracket assembly part no., refer to page 1449.

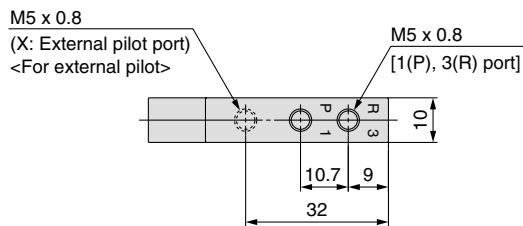

### VQZ115□-□G□1-M5-PR

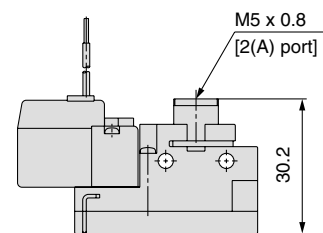

Note) For one-touch fittings for P/R port and silencer part no., refer to page 1470.

### L-type plug connector (L): VQZ115□-□L□1-C3, C4, C6-PR

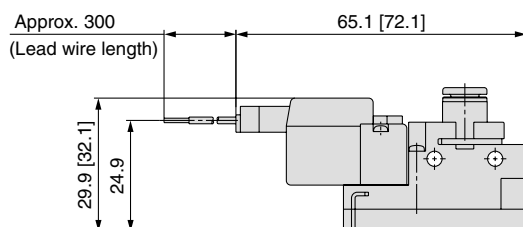

Unless otherwise indicated, dimensions are the same as Grommet (G).  
[ ] : AC

### M-type plug connector (M): VQZ115□-□M□1-C3, C4, C6-PR

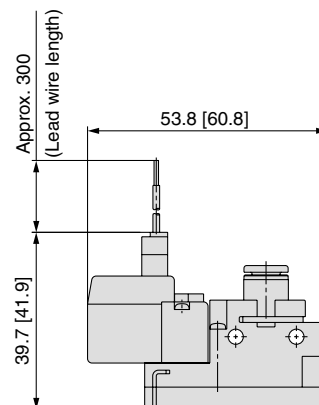

Unless otherwise indicated, dimensions are the same as Grommet (G).  
[ ] : AC



## Dimensions: VQZ200

### Single Unit

#### Grommet (G): VQZ2□2□-□G□1-C4, C6

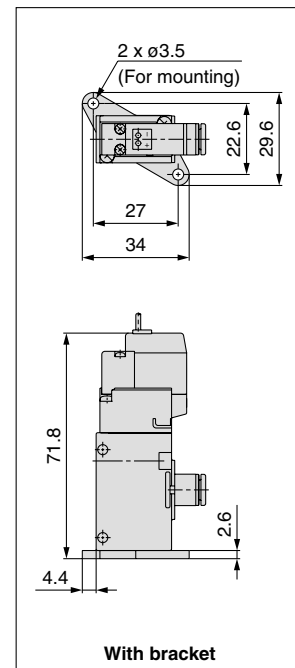
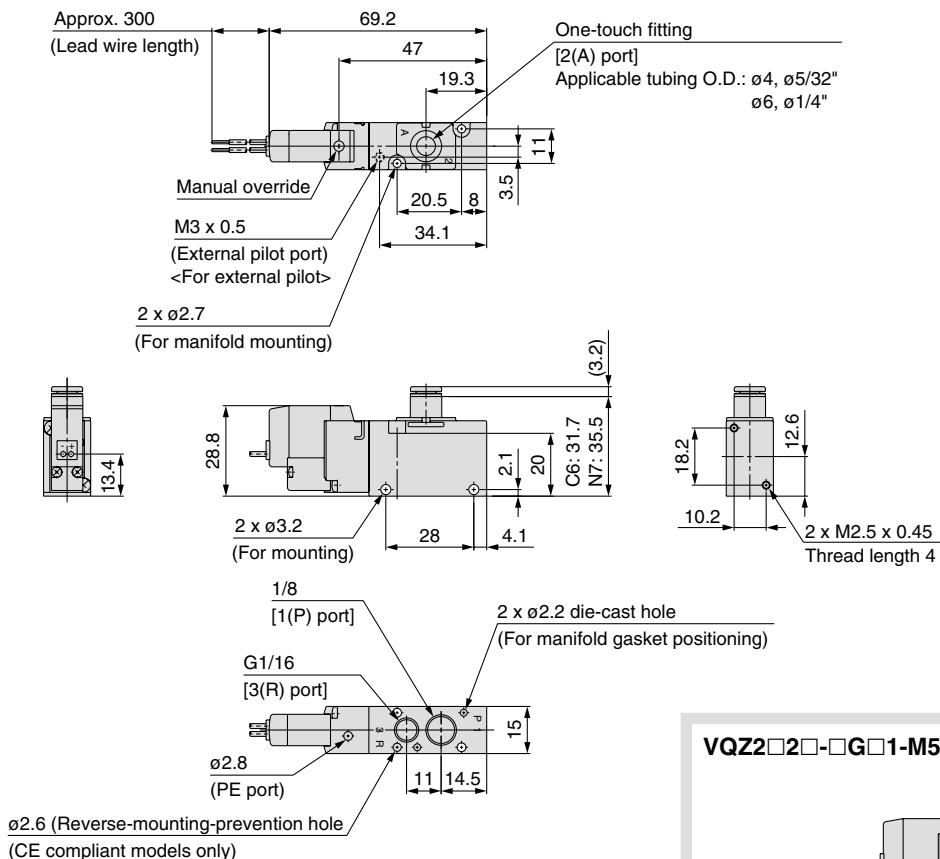

Note) For bracket assembly part no., refer to page 1449.

#### VQZ2□2□-□G□1-M5

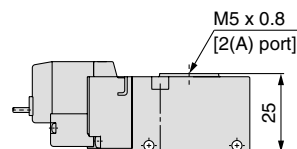

Note) For one-touch fittings for P/R port and silencer part no., refer to page 1470.

#### L-type plug connector (L): VQZ2□2□-□L□1-C4, C6

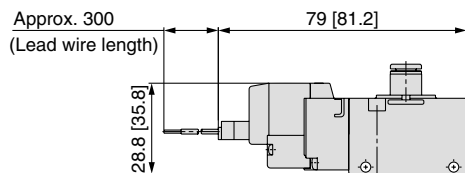

Unless otherwise indicated, dimensions are the same as Grommet (G). [ ]: AC

#### M-type plug connector (M): VQZ2□2□-□M□1-C4, C6

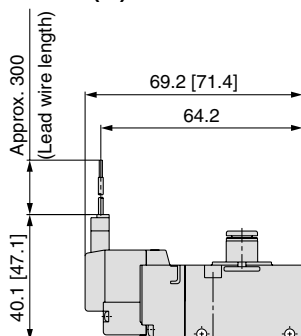

Unless otherwise indicated, dimensions are the same as Grommet (G). [ ]: AC

#### DIN terminal (Y): VQZ2□2□-□Y□1-C4, C6

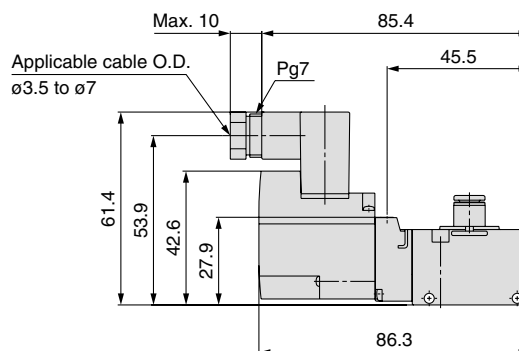

Unless otherwise indicated, dimensions are the same as Grommet (G).

SYJ

VQZ

VP

VG

VP3□

# Series VQZ100/200/300

## Dimensions: VQZ300

### Single Unit

#### Grommet (G): VQZ3□2□-□G□1-C6, C8, C10

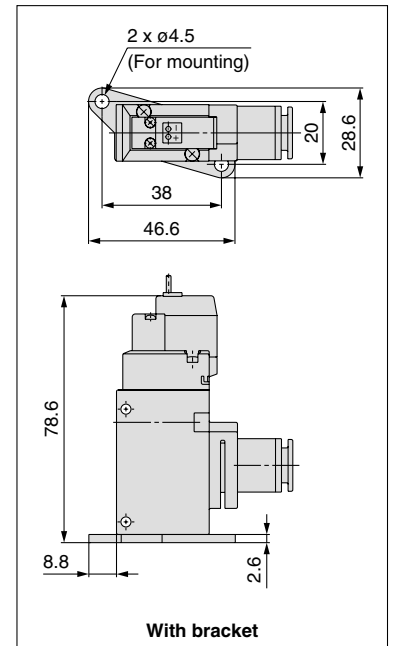
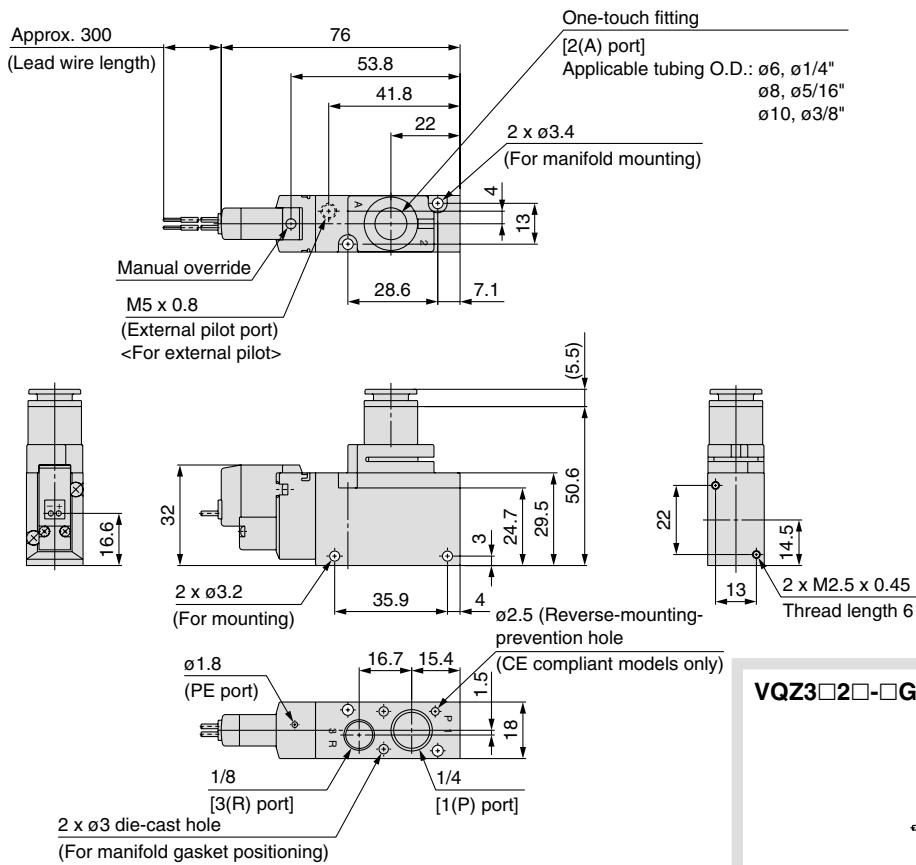

Note) For bracket assembly part no., refer to page 1449.

#### VQZ3□2□-□G□1-02

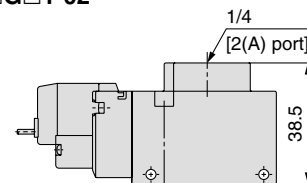

#### L-type plug connector (L): VQZ3□2□-□L□1-C6, C8, C10

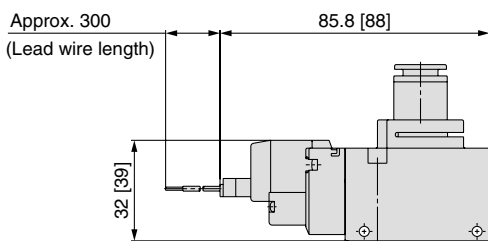

Unless otherwise indicated, dimensions are the same as Grommet (G).  
[ ]: AC

#### M-type plug connector (M): VQZ3□2□-□M□1-C6, C8, C10

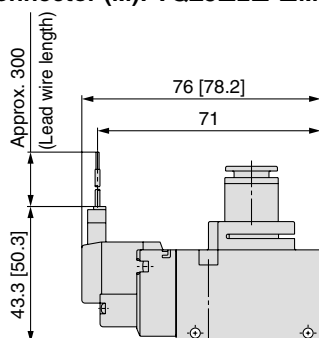

Unless otherwise indicated, dimensions are the same as Grommet (G).  
[ ]: AC

#### DIN terminal (Y): VQZ3□2□-□Y□□1-C6, C8, C10

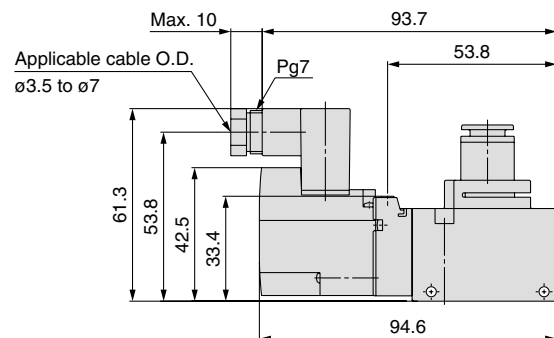

Unless otherwise indicated, dimensions are the same as Grommet (G).

Body Ported  
Plug Lead Unit

# 3 Port Solenoid Valve

## Series VQZ100/200/300

### Manifold Connector Kit



#### VQZ100 / How to Order Manifold

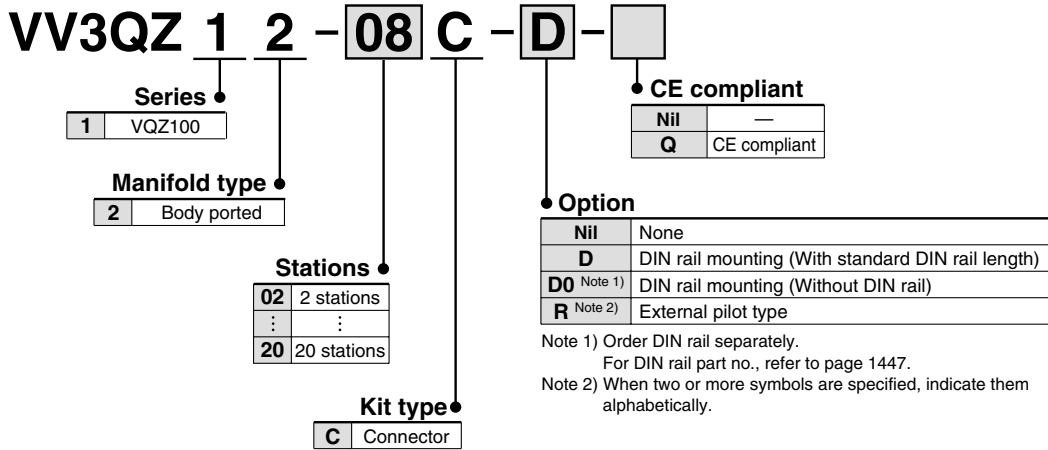

Note) For 1(P), 3(R) of optional thread type, refer to page 1448.

#### VQZ100 / How to Order Valve

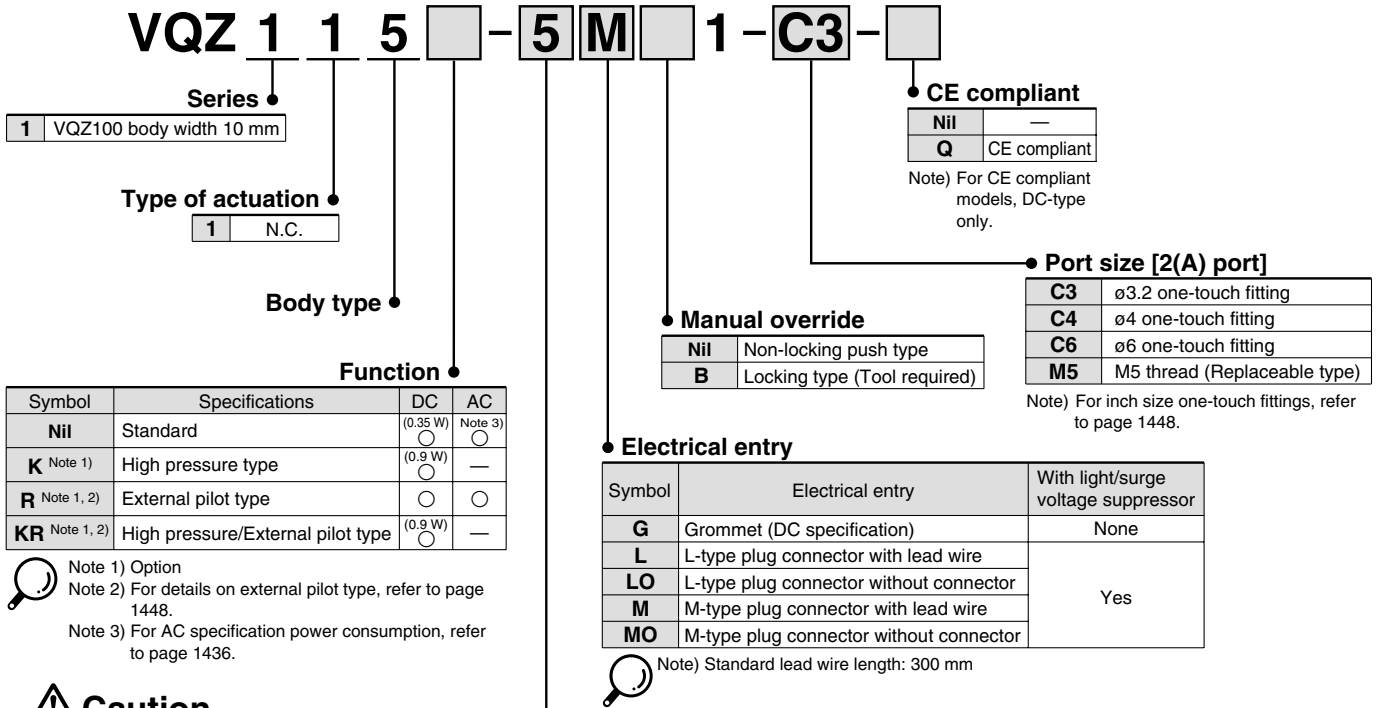

**Caution**  
Use standard (DC) specification for continuous duty.

**Coil voltage**

1	100 VAC (50/60 Hz)
2	200 VAC (50/60 Hz)
3	110 VAC [115 VAC] (50/60 Hz)
4	220 VAC [230 VAC] (50/60 Hz)
5	24 VDC
6	12 VDC

SYJ  
VQZ  
VP  
VG  
VP3□

## VQZ200/300 / How to Order Manifold



Made to Order  
(For details, refer to page 1467.)

VV3QZ **2** **2** - **08** **C** - **□** - **□**

**Series**

2	VQZ200
3	VQZ300

**Manifold type**

2	Body ported
---	-------------

**Stations**

02	2 stations
⋮	⋮
20	20 stations

**Kit type**

C	Connector
---	-----------

**CE compliant**

Nil	—
Q	CE compliant

**Option**

Nil	None
D	DIN rail mounting (With standard DIN rail length)
D0 <sup>Note)</sup>	DIN rail mounting (Without DIN rail)

Note) Order DIN rail separately.  
For DIN rail part no., refer to page 1447.

Note) For 1(P), 3(R) of optional thread type, refer to page 1448.

## VQZ200/300 / How to Order Valve

VQZ **2** **1** **2** **□** - **5** **M** **□** **□** **1** - **□** - **□**

**Series**

2	VQZ200 body width 15 mm
3	VQZ300 body width 18 mm

**Type of actuation**

1	N.C.	Metal seal
2	N.O.	Metal seal
3	N.C.	Rubber seal
4	N.O.	Rubber seal

**Body type**

2	Body ported
---	-------------

**Function**

Symbol	Specifications	DC (0.35 W)	AC (Note 3)
Nil	Standard	○	○
B <sup>Note 1)</sup>	High speed response type	(0.9 W) ○	—
K <sup>Note 1)</sup>	High pressure type (Metal seal type only)	(0.9 W) ○	—
R <sup>Note 1, 2)</sup>	External pilot type	○	○
BR <sup>Note 1, 2)</sup>	High speed response/External pilot type	(0.9 W) ○	—
KR <sup>Note 1, 2)</sup>	High pressure/External pilot type (Metal seal type only)	(0.9 W) ○	—

Note 1) Option  
Note 2) For details on external pilot type, refer to page 1448.  
Note 3) For AC specification power consumption, refer to page 1436.



**Caution**  
Use standard (DC) specification for continuous duty.

**Coil voltage**

1	100 VAC (50/60 Hz)
2	200 VAC (50/60 Hz)
3	110 VAC [115 VAC] (50/60 Hz)
4	220 VAC [230 VAC] (50/60 Hz)
5	24 VDC
6	12 VDC

**IP65 compliant**

Nil	—
W <sup>Note)</sup>	Compliant

Note) VQZ200/300 DIN terminal rubber seal only (except external pilot). For details on IP65 enclosure, refer to page 1448.

**CE compliant**

Nil	—
Q	CE compliant

Note) AC-type models that are CE compliant have DIN terminals only.

**Port size [2(A) port]**

Symbol	Port size	VQZ200	VQZ300
C4	ø4 one-touch fitting	○	—
C6	ø6 one-touch fitting	○	○
C8	ø8 one-touch fitting	—	○
C10	ø10 one-touch fitting	—	○
M5	M5 thread	○	—
02	Rc 1/4	—	○

Note) For inch size one-touch fittings and optional thread type, refer to page 1448.

**Manual override**

Nil	Non-locking push type (Tool required)
B	Locking type (Tool required)

**Electrical entry**

Symbol	Electrical entry	Light/surge voltage suppressor
G	Grommet (DC specification)	None
L	L-type plug connector with lead wire	Yes
LO	L-type plug connector without connector	
M	M-type plug connector with lead wire	
MO	M-type plug connector without connector	
Y	DIN terminal	None
YO	DIN terminal without connector	Yes
YZ	DIN terminal	
YS <sup>Note 2)</sup>	DIN terminal (DC specification)	
YOS <sup>Note 2)</sup>	DIN terminal without connector (DC specification)	(Without light)

Note 1) Standard lead wire length: 300 mm  
Note 2) For AC voltage valves there is no "S" option. It is already built-in to the rectifier circuit.

## Manifold Specifications

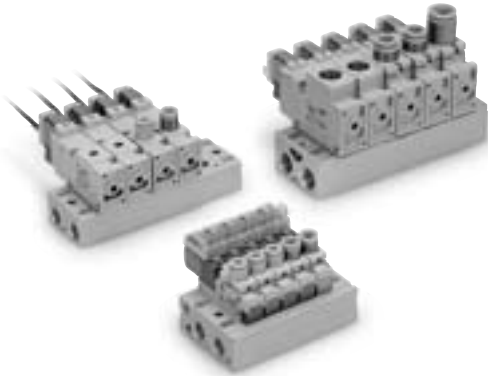

Series	Base model	Piping specifications			Applicable solenoid valve	Applicable stations	Manifold base mass (g)
		Piping direction	Port size				
			1(P), 3(R)	2(A)			
VQZ100	VV3QZ12-□□□	Top	Rc 1/8	C3 (for ø3.2) C4 (for ø4) C6 (for ø6) M5 (M5 thread)	VQZ115	2 to 20 stations	2 stations: 83 Addition per station: 19
VQZ200	VV3QZ22-□□□	Top	Rc 1/8	C4 (for ø4) C6 (for ø6) M5 (M5 thread)	VQZ2□2	2 to 20 stations	2 stations: 68 Addition per station: 20
VQZ300	VV3QZ32-□□□	Top	Rc 1/4	C6 (for ø6) C8 (for ø8) C10 (for ø10) Rc 1/4	VQZ3□2	2 to 20 stations	2 stations: 114 Addition per station: 37

## How to Order Manifold Assembly (Example)

**VV3QZ22-05C** ..... 1 set (C kit 5-station manifold base part no.)

\* **VVQZ200-10A-2** ... 1 set (Blanking plate assembly part no.)

\* **VQZ212-5M1-C6** ... 4 sets (N.C. type part no.)

→ The asterisk denotes the symbol for assembly. Prefix it to the part nos. of the solenoid valve, etc.

→ Enter in order starting from the first station on the D side.

Add the valve and option part number under the manifold base part number.  
When entry of part numbers becomes complicated, indicate by the manifold specification sheet.

SYJ

VQZ

VP

VG

VP3□

# Series VQZ100/200/300

## Dimensions: VQZ100

### VV3QZ12- Stations C

#### Grommet (G)

U side

D side

One-touch fitting

[2(A) port]

Applicable tubing O.D.:  $\phi 3.2, \phi 1/8"$   
 $\phi 4, \phi 5/32"$   
 $\phi 6, \phi 1/4"$

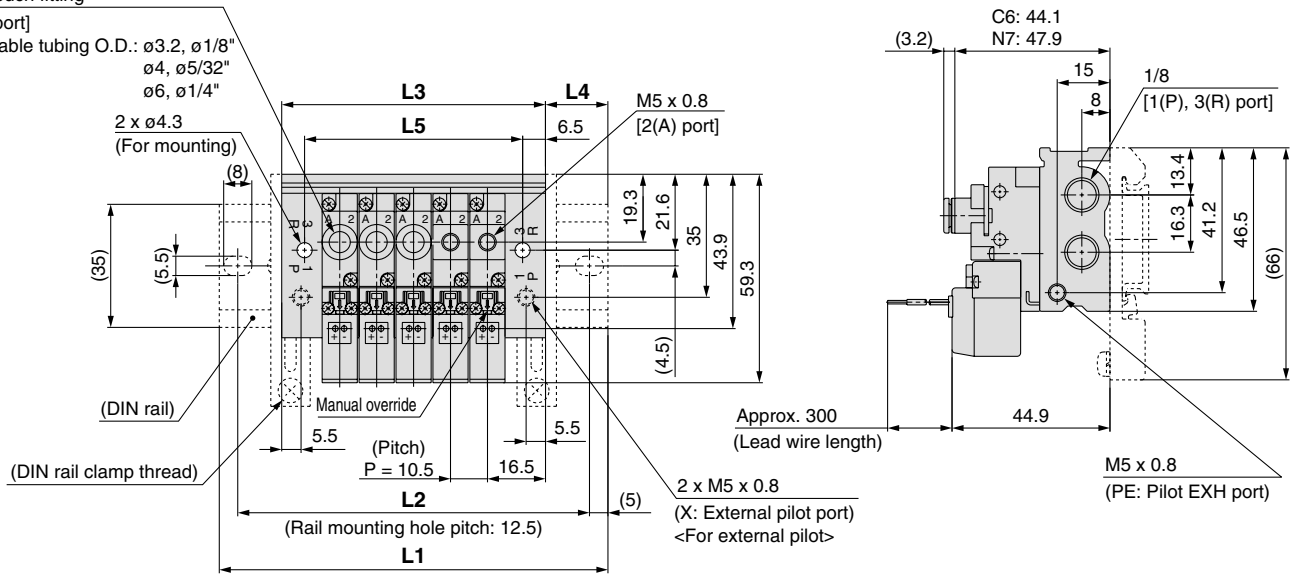

(Station n) ----- (Station 1)

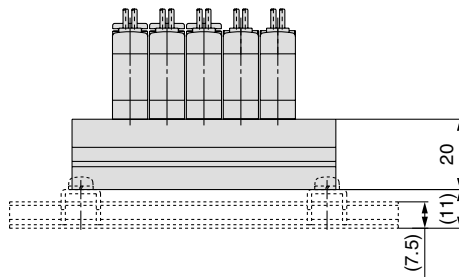

The dashed lines indicate the DIN rail mounting [-D].

#### M5

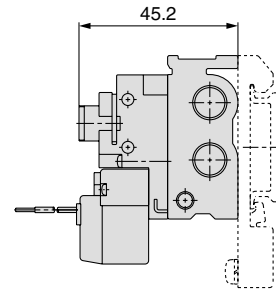

#### L-type plug connector (L)

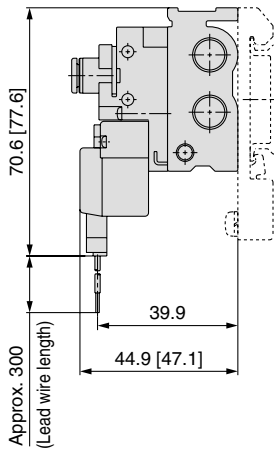

Unless otherwise indicated, dimensions are the same as Grommet (G).  
 [ ]: AC

#### M-type plug connector (M)

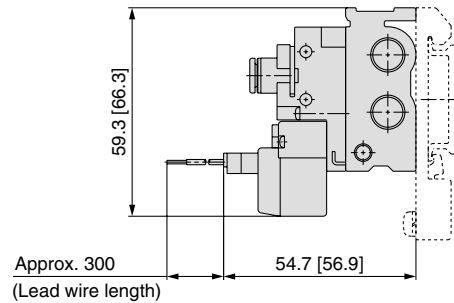

Unless otherwise indicated, dimensions are the same as Grommet (G).  
 [ ]: AC

#### Dimensions

Formula:  $L5 = 10.5n + 9.5$   $L3 = 10.5n + 22.5$  n: Stations (Max. 20 stations)

L \ n	2	3	4	5	6	7	8	9	10	11	12	13	14	15	16	17	18	19	20
L1	85.5	85.5	98	110.5	123	135.5	148	148	160.5	173	185.5	198	210.5	210.5	223	235.5	248	260.5	273
L2	75	75	87.5	100	112.5	125	137.5	137.5	150	162.5	175	187.5	200	200	212.5	225	237.5	250	262.5
L3	43.5	54	64.5	75	85.5	96	106.5	117	127.5	138	148.5	159	169.5	180	190.5	201	211.5	222	232.5
L4	21	16	17	18	19	20	21	15.5	16.5	17.5	18.5	19.5	20.5	15.5	16.5	17.5	18.5	19.5	20.5
L5	30.5	41	51.5	62	72.5	83	93.5	104	114.5	125	135.5	146	156.5	167	177.5	188	198.5	209	219.5

## Dimensions: VQZ200

### VV3QZ22- Stations C

#### Grommet (G)

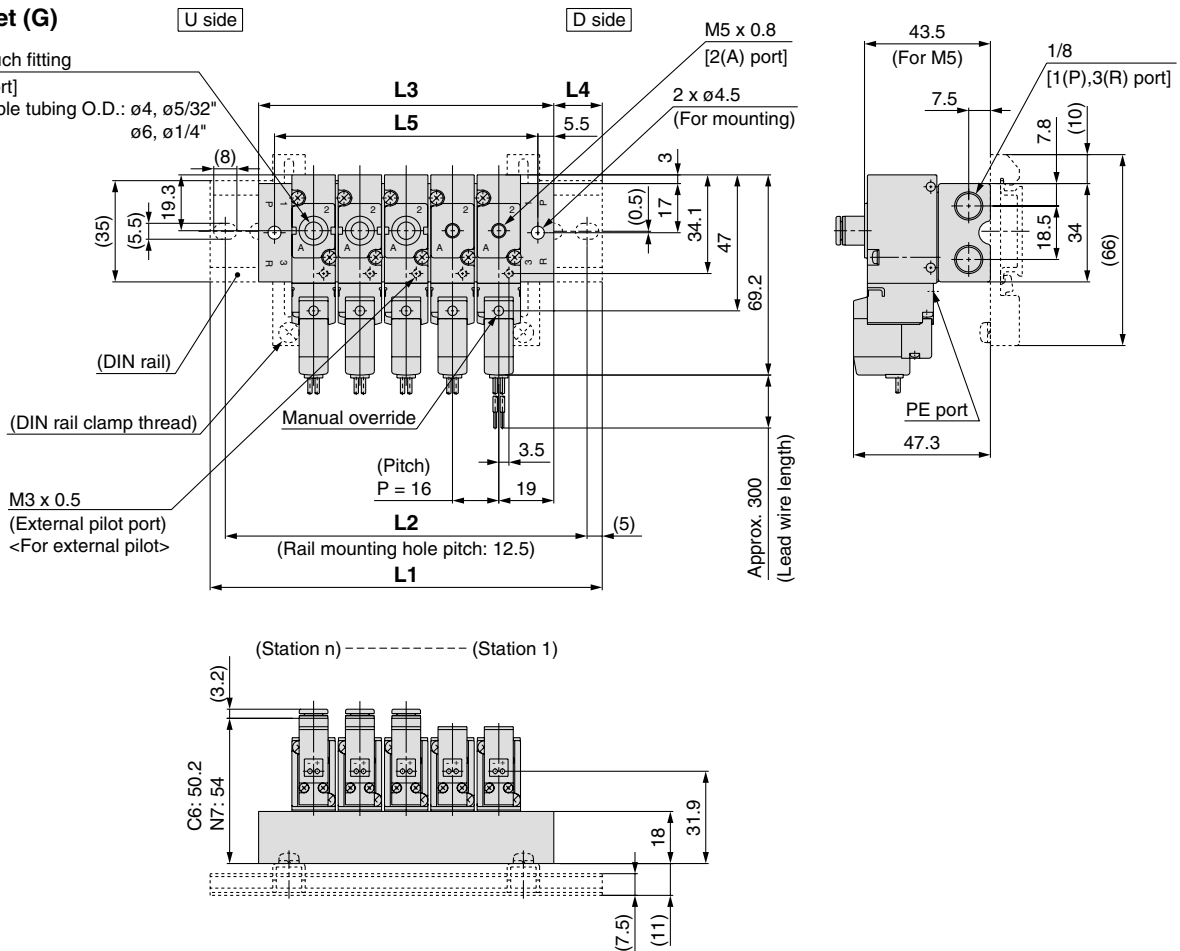

The dashed lines indicate the DIN rail mounting [-D].

#### L-type plug connector (L)

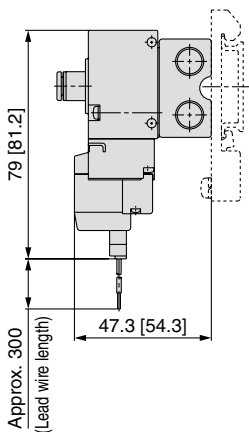

Unless otherwise indicated, dimensions are the same as Grommet (G).  
[ ]: AC

#### M-type plug connector (M)

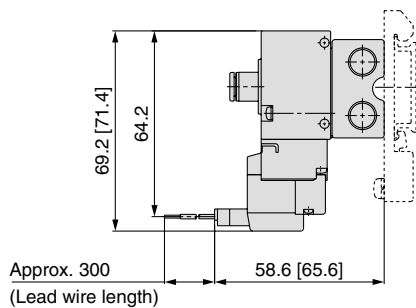

Unless otherwise indicated, dimensions are the same as Grommet (G).  
[ ]: AC

#### DIN terminal (Y)

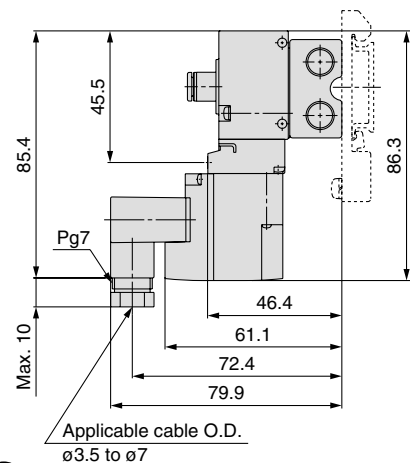

Unless otherwise indicated, dimensions are the same as Grommet (G).

#### Dimensions

Formula:  $L5 = 16n + 11$     $L3 = 16n + 22$    n: Stations (Max. 20 stations)

L \ n	2	3	4	5	6	7	8	9	10	11	12	13	14	15	16	17	18	19	20
L1	85.5	110.5	123	135.5	148	173	185.5	198	223	235.5	248	260.5	285.5	298	310.5	335.5	348	360.5	373
L2	75	100	112.5	125	137.5	162.5	175	187.5	212.5	225	237.5	250	275	287.5	300	325	337.5	350	362.5
L3	54	70	86	102	118	134	150	166	182	198	214	230	246	262	278	294	310	326	342
L4	16	20.5	18.5	17	15	19.5	18	16	20.5	19	17	15.5	20	18	16.5	21	19	17.5	15.5
L5	43	59	75	91	107	123	139	155	171	187	203	219	235	251	267	283	299	315	331

# Series VQZ100/200/300

## Dimensions: VQZ300

### VV3QZ32- Stations C

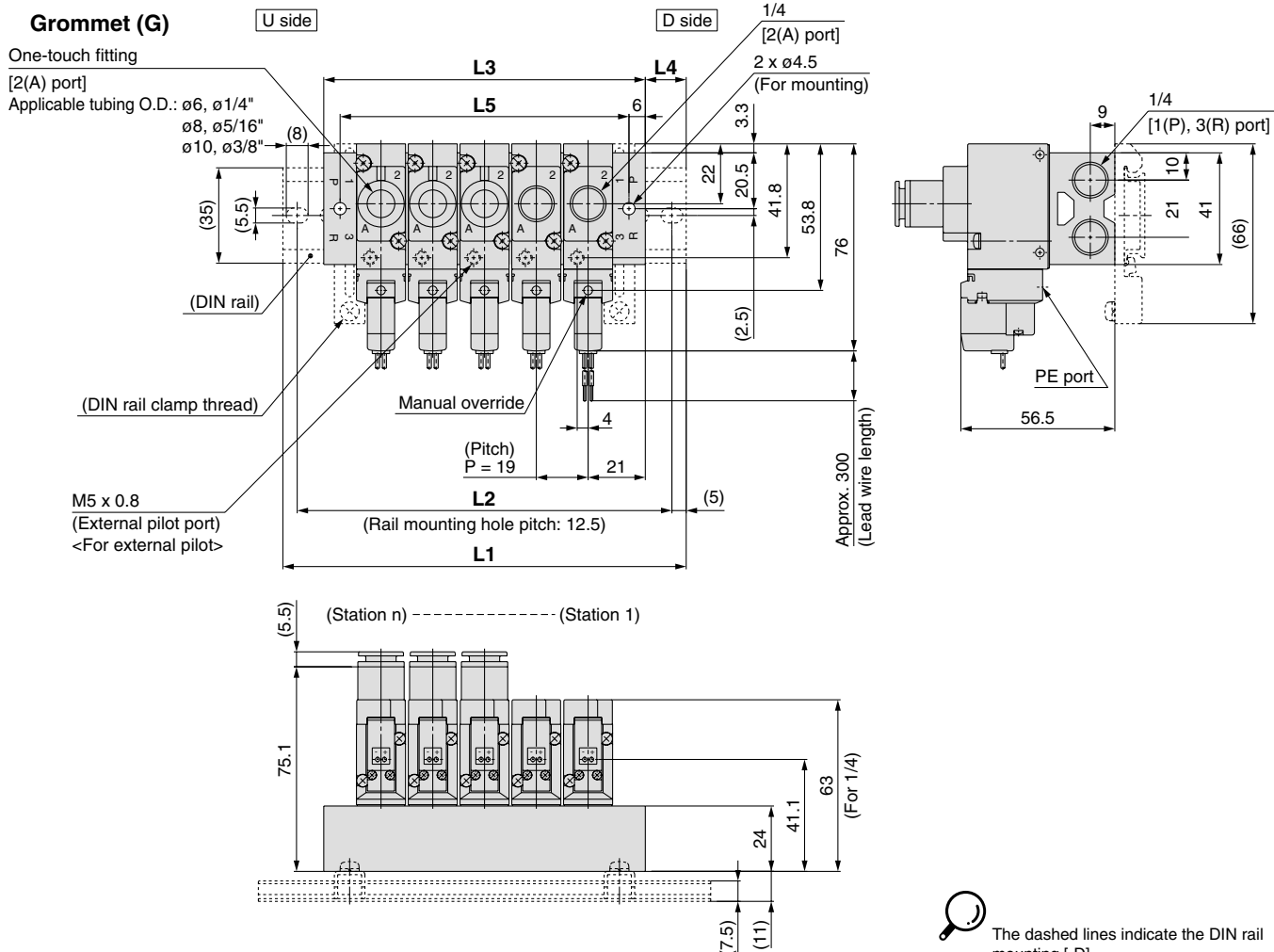

The dashed lines indicate the DIN rail mounting [-D].

#### L-type plug connector (L)

Unless otherwise indicated, dimensions are the same as Grommet (G).  
 [ ] : AC

#### M-type plug connector (M)

Unless otherwise indicated, dimensions are the same as Grommet (G).  
 [ ] : AC

#### DIN terminal (Y)

Unless otherwise indicated, dimensions are the same as Grommet (G).

**Dimensions** Formula:  $L5 = 19n + 11$   $L3 = 19n + 23$  n: Stations (Max. 20 stations)

L \ n	2	3	4	5	6	7	8	9	10	11	12	13	14	15	16	17	18	19	20
L1	98	110.5	135.5	148	173	198	210.5	235.5	248	273	285.5	310.5	323	348	360.5	385.5	398	423	435.5
L2	87.5	100	125	137.5	162.5	187.5	200	225	237.5	262.5	275	300	312.5	337.5	350	375	387.5	412.5	425
L3	61	80	99	118	137	156	175	194	213	232	251	270	289	308	327	346	365	384	403
L4	18.5	15.5	18.5	15	18	21	18	21	17.5	20.5	17.5	20.5	17	20	17	20	16.5	19.5	16.5
L5	49	68	87	106	125	144	163	182	201	220	239	258	277	296	315	334	353	372	391



## Manifold Options

### Blanking plate assembly

VVQZ100-10A-5 (for VQZ100)

VVQZ200-10A-2 (for VQZ200)

VVQZ300-10A-2 (for VQZ300)

It is used by attaching on the manifold block for being prepared for removing a valve for maintenance reasons or planning to mount a spare valve, etc.

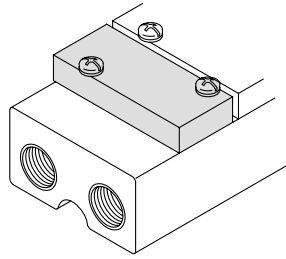

### Blanking plug

KQ2P-23

KQ2P-04

KQ2P-06

KQ2P-08

KQ2P-10

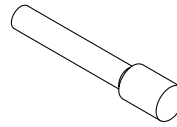
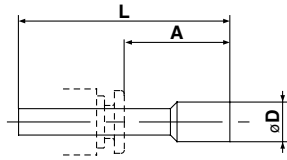

#### Dimensions

Applicable fitting size ød	Model	A	L	D
3.2	KQ2P-23	16	31.5	3.2
4	KQ2P-04	16	32	6
6	KQ2P-06	18	35	8
8	KQ2P-08	20.5	39	10
10	KQ2P-10	22	43	12

### DIN rail

AXT100-DR-□

\* As for □, enter the number from the DIN rail dimensions table.  
For L dimension, refer to the dimensions of each kit.

Each manifold can be mounted on a DIN rail.

Insert "D" at the end of the manifold part number.

The DIN rail is approximately 30 mm longer than the length of manifold.

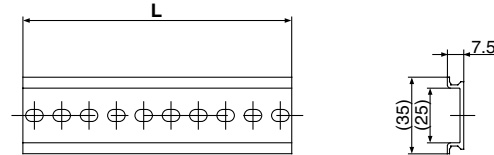

#### L Dimension

$$L = 12.5n + 10.5$$

No.	1	2	3	4	5	6	7	8	9	10	11	12	13	14	15	16	17	18	19	20
L dimension	23	35.5	48	60.5	73	85.5	98	110.5	123	135.5	148	160.5	173	185.5	198	210.5	223	235.5	248	260.5
No.	21	22	23	24	25	26	27	28	29	30	31	32	33	34	35	36	37	38	39	40
L dimension	273	285.5	298	310.5	323	335.5	348	360.5	373	385.5	398	410.5	423	435.5	448	460.5	473	485.5	498	510.5

### Silencer

(for manifold EXH port)

Silencer is installed in the manifold EXH port.

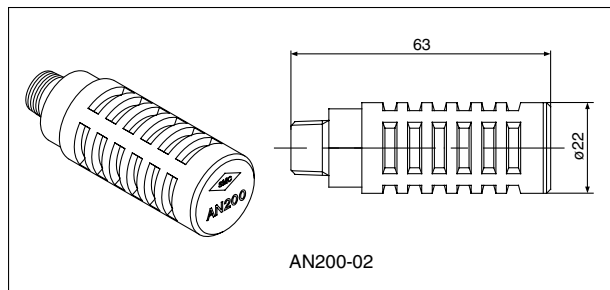
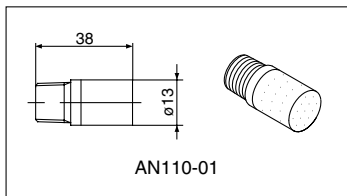

#### Dimensions

Model	Silencer part no.
VQZ100	AN110-01
VQZ200	AN110-01
VQZ300	AN200-02



For a silencer to be mounted in a single valve unit, refer to page 1470.

SYJ

VQZ

VP

VG

VP3□

# Series VQZ Body Ported

## Options

### External Pilot Specification

The external pilot specification is used when the operating pressure is below the minimum operating pressure 0.1 to 0.15 MPa or when valve is used for a vacuum application. Order a valve by adding the external pilot specification [R] to the part number.

Valve Part No.



• Entry is the same as standard products.

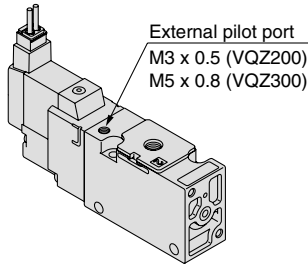

### Pressure Specifications

Series		VQZ100 <sup>Note 2)</sup>	VQZ200/300
External pilot pressure range	<sup>Note 1)</sup> Metal seal	—	0.1 to 0.7 MPa
	Rubber seal (VQZ100: poppet)	0.2 to 0.7 MPa	0.15 to 0.7 MPa
Operating pressure range <sup>Note 1)</sup>		-100 kPa to 0.7 MPa	

• <sup>Note 1)</sup> In case of the high pressure type, upper limit of max. operating pressure and external pilot pressure range is 1 MPa.  
 • <sup>Note 2)</sup> Pump down from 1(P) port when VQZ100 series vacuum type is specified. Apply pressure from 3(R) port to relieve vacuum pressure. Set the release pressure at 50% of external pilot pressure or less.

### Inch Size One-touch Fittings and Optional Threads

Inch size one-touch fittings and NPT, NPTF and G thread are available.

Valve Part No.



• Entry is the same as standard products.

		Cylinder port						
Symbol		N1	N3	N7	N9	N11	M5	O2
Applicable tubing O.D. (Inch)		ø1/8"	ø5/32"	ø1/4"	ø5/16"	ø3/8"	M5 thread	1/4 thread
2(A) port	VQZ100	●	●	●	—	—	●	—
	VQZ200	—	●	●	—	—	●	—
	VQZ300	—	—	●	●	●	—	●

• Thread type (Cylinder port and 1(P), 3(R) ports)

Nil	Rc
N	NPT
T	NPTF
F	G

• <sup>Note 1)</sup> 3(R) port of the VQZ200 is only G1/16.  
 • <sup>Note 2)</sup> Except VQZ100

• <sup>Note)</sup> Metric size one-touch fittings (□) are also available.

Manifold Part No.

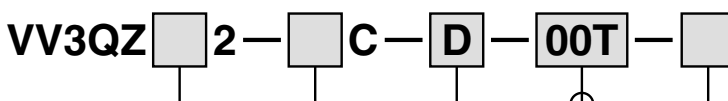

• Entry is the same as standard products.

• Thread type (1(P), 3(R) ports)

Nil	Rc
00N	NPT
00T	NPTF
00F	G

### IP65 Enclosure (Based on IEC60529)

DIN terminal is available with IP65 enclosure.

Valve Part No.

(Applicable to the VQZ200/300 rubber seal with the exception of the external pilot type)

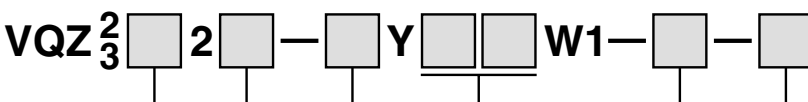

• Entry is the same as standard products.

• <sup>Note)</sup> The pilot exhaust IP65 valves is common with main valve exhaust. (The standard valve has an individual exhaust for the pilot valve.)

# Replacement Parts

## One-touch Fitting Assembly (for Cylinder port)

Fitting size	C3	C4	C6	C8	C10	M5 (VQZ100 only)
<b>VQZ100/200</b>	VVQ1000-50A-C3	VVQ1000-50A-C4	VVQ1000-50A-C6	—	—	VVQ1000-50A-M5
<b>VQZ300</b>	—	—	VVQ1000-51A-C6	VVQ1000-51A-C8	VVQ1000-51A-C10	—

Note) Purchasing order is available in units of 10 pieces.

### <Plug connector assembly>

DC: SY100-30-4A-□

100 VAC: SY100-30-1A-□

200 VAC: SY100-30-2A-□

Other AC voltages: SY100-30-3A-□

Without lead wire: SY100-30-A  
(with connector and 2 sockets only)

#### Lead wire length

Symbol	Length
Nil	300 mm
6	600 mm
10	1000 mm
15	1500 mm
20	2000 mm
25	2500 mm
30	3000 mm
50	5000 mm

### How to Order

Include the connector assembly part number together with the part number for the plug connector's solenoid valve without connector.

Example) In case of 2000 mm of lead wire

DC VQZ115-5LO1-M5-PR SY100-30-4A-20  
AC VQZ115-1LO1-M5-PR SY100-30-1A-20

### <Gasket and screw assembly>

Model	Part no.
<b>VQZ100</b>	VQZ100-GS-2
<b>VQZ200</b>	VQZ200-GS-2
<b>VQZ300</b>	VQZ300-GS-2

Note) Above part number consists of 10 units. Each unit has one gasket and two screws. Purchasing order is available in units of 10 pieces.

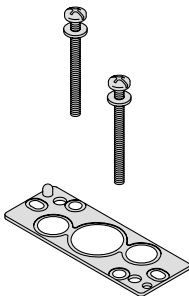

### <Pilot valve assembly>

V111 □ □ — 5 G □ □

Symbol	Specifications	DC (0.35 W)	AC (0.9 W)
Nil	Standard	○	○
<b>B</b> Note)	High speed response type (Applicable to VQZ200/300)	○	—
<b>K</b> Note)	High pressure type (Applicable to Metal seal type, Poppet seal type)	○	—

Note) Option

#### Manual override

Nil	None (Applicable to VQZ200/300)
<b>M</b>	Yes (Applicable to VQZ100)

#### Manual override (Applicable to the VQZ100)

Nil	Non-locking push type
<b>B</b>	Locking slotted type

#### Coil voltage

1	100 VAC (50/60 Hz)
2	200 VAC (50/60 Hz)
3	110 VAC (50/60 Hz)
4	220 VAC (50/60 Hz)
5	24 VDC
6	12 VDC

#### Electrical entry

Symbol	Electrical entry	Light/surge voltage suppressor
DC AC		
<b>G</b>	— Grommet (DC specification)	None
<b>LU LZ</b>	L-type plug connector with lead wire	Yes
<b>LOU LOZ</b>	L-type plug connector without connector	
<b>MU MZ</b>	M-type plug connector with lead wire	
<b>MOU MOZ</b>	M-type plug connector without connector	

Note) VQZ pilot valve electrical entry (L, M) is the opposite of the how to order of valve body.

Valve model	Pilot valve model
VQZ115□-□L□1	V111□M-□M□
VQZ115□-□M□1	V111□M-□L□

### <DIN terminal type (Applicable to the VQZ200/300)>

V115 □ □ — 5 Y — X110

Symbol	Specifications	DC (0.35 W)	AC (0.9 W)
Nil	Standard	○	○
<b>B</b> Note)	High speed response type	○	—
<b>K</b> Note)	High pressure type (Metal seal type only)	○	—

Note) Option

#### Coil voltage

1	100 VAC (50/60 Hz)
2	200 VAC (50/60 Hz)
3	110 VAC (50/60 Hz)
4	220 VAC (50/60 Hz)
5	24 VDC
6	12 VDC

#### Electrical entry

Symbol	Electrical entry	Light/surge voltage suppressor
<b>Y</b>	DIN terminal	None
<b>YO</b>	DIN terminal without connector	
<b>YZ</b>	DIN terminal with light/surge voltage suppressor	Yes
<b>YS</b> Note)	DIN terminal with surge voltage suppressor (DC specification)	Yes (Without light)
<b>YOS</b> Note)	DIN terminal with surge voltage suppressor, without connector (DC specification)	

Note) For AC voltage valves there is no "S" option. It is already built-in to the rectifier circuit.

### Caution

When replacing only the pilot valve assembly, use caution because it is not possible to convert to a V115 (DIN terminal) from a V111 (Grommet, L-type, M-type), or vice versa.

### <Bracket assembly>

Model	Part no.	Tightening torque (N·m) Note)
<b>VQZ100</b>	VQZ100-FB	0.45 to 0.55
<b>VQZ200</b>	VQZ200-FB	0.25 to 0.35
<b>VQZ300</b>	VQZ300-FB	0.25 to 0.35

Note) Tightening torque when mounting a bracket on the valve.

SYJ  
VQZ  
VP  
VG  
VP3□

# 3 Port Solenoid Valve

# Series VQZ100/200/300

# Single Unit



## VQZ100 / How to Order Valve

VQZ 1 1 5 [ ] - 5 M [ ] 1 - 01 - [ ]

Series

1	VQZ100 body width 10 mm
---	-------------------------

Type of actuation

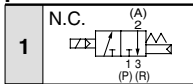

Body type

5	Base mounted
---	--------------

Function

Symbol	Specifications	DC	AC
Nil	Standard	(0.35 W)	Note 3)
K Note 1)	High pressure type	(0.9 W)	—
R Note 1, 2)	External pilot type		
KR Note 1, 2)	High pressure/External pilot type	(0.9 W)	—



Note 1) Option  
 Note 2) For details on external pilot type, refer to page 1465.  
 Note 3) For AC specification power consumption, refer to page 1452.

### Caution

Use standard (DC) specification for continuous duty.

CE compliant

Nil	—
Q	CE compliant

Note) For CE compliant models, DC-type only.

Port size [2(A) port]

CP	Without sub-plate
01	Rc 1/8

Note) For optional thread type, refer to page 1465.

Manual override

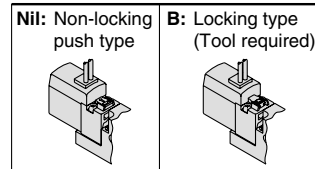

Electrical entry

G: Grommet (DC specification)	L: L-type plug connector with lead wire	LO: L-type plug connector without connector	M: M-type plug connector with lead wire	MO: M-type plug connector without connector
	With light/surge voltage suppressor	With light/surge voltage suppressor	With light/surge voltage suppressor	With light/surge voltage suppressor



Note) Standard lead wire length: 300 mm

Coil voltage

1	100 VAC (50/60 Hz)
2	200 VAC (50/60 Hz)
3	110 VAC [115 VAC] (50/60 Hz)
4	220 VAC [230 VAC] (50/60 Hz)
5	24 VDC
6	12 VDC

Note) For sub-plate part no., refer to page 1466.

## VQZ200/300 / How to Order Valve



Made to Order

(For details, refer to page 1452 and 1467.)

VQZ **2** **1** **5** **5** **M** **1** - -

Series

2	VQZ200 body width 15 mm
3	VQZ300 body width 18 mm

Type of actuation

1	N.C.	(A)	Metal seal
		2 3 1 (R) (P)	
2	N.O.	(A)	Metal seal
		2 3 1 (R) (P)	
3	N.C.	(A)	Rubber seal
		2 3 1 (R) (P)	
4	N.O.	(A)	Rubber seal
		2 3 1 (R) (P)	

Body type

5	Body mounted
---	--------------

Function

Symbol	Specifications	DC	AC
Nil	Standard	(0.35 W)	Note 3)
B Note 1)	High speed response type	(0.9 W)	—
K Note 1)	High pressure type (Metal seal type only)	(0.9 W)	—
R Note 1, 2)	External pilot type		
BR Note 1, 2)	High speed response/External pilot type	(0.9 W)	—
KR Note 1, 2)	High pressure/External pilot type (Metal seal type only)	(0.9 W)	—



Note 1) Option

Note 2) For details on external pilot type, refer to page 1465.

Note 3) For AC specification power consumption, refer to page 1452.

### Caution

Use standard (DC) specification for continuous duty.

IP65 compliant

Nil	—
W Note)	Compliant

Note) VQZ200/300 DIN terminal rubber seal only (except external pilot). For details on IP65 enclosure, refer to page 1465.

CE compliant

Nil	—
Q	CE compliant

Note) AC-type models that are CE compliant have DIN terminals only.

Port size [2(A) port]

Symbol	Port size	VQZ200	VQZ300
Nil	Without sub-plate		
01	Rc 1/8		—
02	Rc 1/4		
03	Rc 3/8	—	

Note) For optional thread type, refer to page 1465.

Manual override

Nil: Non-locking push type (Tool required)      B: Locking type (Tool required)

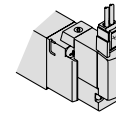
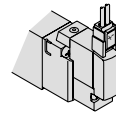

Electrical entry

G: Grommet (DC specification)	L: L-type plug connector with lead wire	LO: L-type plug connector without connector	M: M-type plug connector with lead wire	MO: M-type plug connector without connector
	With light/surge voltage suppressor 	With light/surge voltage suppressor 	With light/surge voltage suppressor 	With light/surge voltage suppressor 
Y: DIN terminal 	YO: DIN terminal without connector 	YZ: DIN terminal 	YOS: DIN terminal without connector (DC specification) 	YS: DIN terminal (DC specification) 
		With light/surge voltage suppressor 	With surge voltage suppressor 	With surge voltage suppressor 



Note 1) Standard lead wire length: 300 mm

Note 2) For AC voltage valves there is no "S" option. It is already built-in to the rectifier circuit.

Coil voltage

1	100 VAC (50/60 Hz)
2	200 VAC (50/60 Hz)
3	110 VAC [115 VAC] (50/60 Hz)
4	220 VAC [230 VAC] (50/60 Hz)
5	24 VDC
6	12 VDC

Note) For sub-plate part no., refer to page 1466.

SYJ

VQZ

VP

VG

VP3□

# Series VQZ100/200/300



## Specifications

Valve construction	Metal seal	Rubber seal	VQZ100 (Poppet seal)
Fluid	Air, Inert gas		
Max. operating pressure (MPa)	0.7 (High pressure type: 1.0)	0.7	0.7 (High pressure type: 1.0)
Min. operating pressure (MPa)	0.1	0.15	0.15
Ambient and fluid temperature (°C)	-10 to 50 (No freezing)		
Max. operating frequency (Hz)	20	5	20
Pilot exhaust method	Individual exhaust		Common exhaust
Lubrication	Not required		
Manual override	Push type, Locking type (Tool required)		
Mounting orientation	Free		
Impact/Vibration resistance (m/s <sup>2</sup> ) <sup>Note 1)</sup>	150/30		
Enclosure*	Dustproof (DIN terminal: IP65 <sup>Note 2)</sup> )		



\* Based on IEC60529

Note 1) Impact resistance: No malfunction occurred when it is tested with a drop tester in the axial direction and at the right angles to the main valve and armature in both energized and de-energized states every once for each condition. (Value in the initial state)

Vibration resistance: No malfunction occurred in one sweep test between 45 and 2000 Hz. Test was performed to axis and right angle directions of the main valve and armature when pilot signal is ON and OFF. (Value in the initial state)

Note 2) When IP65 compliant DIN terminals are selected: VQZ<sub>3</sub>□5□-□Y□□W1-□-□

## Solenoid Specifications

## Options

High speed response type
High pressure type (Metal seal type only)
External pilot type*

\* For details on external pilot type, refer to page 1465.



**Made to Order**  
(For details, refer to page 1467.)

Symbol	Description
X30	Pilot valve common exhaust
X90	Main valve fluoro-rubber
X113	All fluoro-rubber

Electrical entry		Grommet (G)	M-type plug connector (M)	
		L-type plug connector (L)	DIN terminal (Y)	
		G, L, M	Y	
Coil rated voltage (V)	DC	24, 12		
	AC 50/60 Hz	100, 110, 200, 220*		
Allowable voltage fluctuation		±10% of rated voltage*		
Power consumption (W)	DC	Standard	0.35 [(With light: 0.4 (DIN terminal with light: 0.45)]	
		High speed response, high pressure	0.9 [(With light: 0.95 (DIN terminal with light: 1.0)]	
Apparent power (VA)	AC	100 V	0.78 (With light: 0.81)	0.78 (With light: 0.87)
		110 V [115 V]	0.86 (With light: 0.89) [0.94 (With light: 0.97)]	0.86 (With light: 0.87) [0.94 (With light: 1.07)]
		200 V	1.18 (With light: 1.22)	1.15 (With light: 1.30)
		220 V [230 V]	1.30 (With light: 1.34) [1.42 (With light: 1.46)]	1.27 (With light: 1.46) [1.39 (With light: 1.60)]
Surge voltage suppressor		Varistor		
Indicator light		LED (Neon light when AC with DIN terminal)		



\* In common between 110 VAC and 115 VAC, and between 220 VAC and 230 VAC.

\* For 115 VAC and 230 VAC, the allowable voltage is -15% to +5% of rated voltage.

## Flow Characteristics

Series	Valve construction	Model		Flow characteristics						Response time (ms) <sup>Note 1)</sup>				Note 2) Mass (g)
				1→2 (P→A)			2→3 (A→R)			Standard: 0.35 W	High speed response: 0.9 W	High pressure: 0.9 W	AC	
				C [dm <sup>3</sup> /(s·bar)]	b	Cv	C [dm <sup>3</sup> /(s·bar)]	b	Cv					
VQZ100	N.C. valve	Poppet	VQZ115	0.87	0.46	0.23	1.0	0.35	0.25	10 or less	—	13 or less	22 or less	24
VQZ200	N.C. valve	Metal seal	VQZ215	1.7	0.17	0.38	2.0	0.20	0.45	22 or less	14 or less	18 or less	34 or less	52
		Rubber seal	VQZ235	2.3	0.46	0.65	3.0	0.40	0.80	22 or less	15 or less	—	36 or less	
	N.O. valve	Metal seal	VQZ225	1.7	0.18	0.38	1.8	0.21	0.39	22 or less	14 or less	18 or less	34 or less	
		Rubber seal	VQZ245	2.5	0.43	0.67	3.0	0.30	0.74	22 or less	15 or less	—	36 or less	
VQZ300	N.C. valve	Metal seal	VQZ315	3.0	0.21	0.70	3.2	0.27	0.80	22 or less	17 or less	22 or less	34 or less	78
		Rubber seal	VQZ335	4.5	0.42	1.3	4.1	0.36	1.0	33 or less	25 or less	—	57 or less	
	N.O. valve	Metal seal	VQZ325	2.9	0.21	0.72	2.9	0.16	0.69	22 or less	17 or less	22 or less	34 or less	
		Rubber seal	VQZ345	4.4	0.45	1.2	4.5	0.38	1.2	33 or less	25 or less	—	57 or less	



Note 1) Based on JIS B 8375-1981 (Supply pressure: 0.5 MPa; with light/surge voltage suppressor: clean air)

Response time values will change depending on pressure and air quality.

Note 2) Mass without sub-plate.

## Construction

### VQZ100 Poppet type

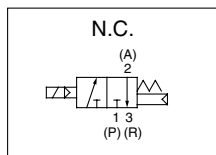
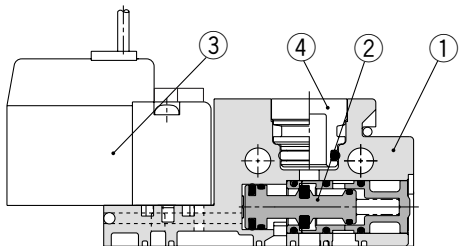

#### Component Parts

No.	Description	Material	Note
1	Body	Resin	
2	Spool valve	Aluminum/HNBR	
3	Pilot valve assembly	—	
4	Port plug	Resin/HNBR	VQZ100-CP

### VQZ200/300 Metal seal type

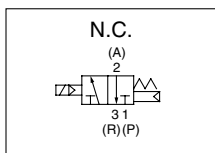
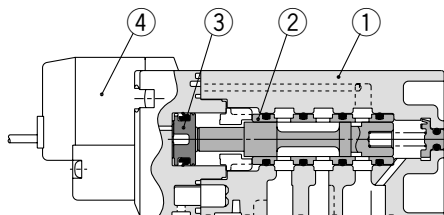

### Rubber seal type

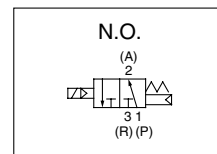
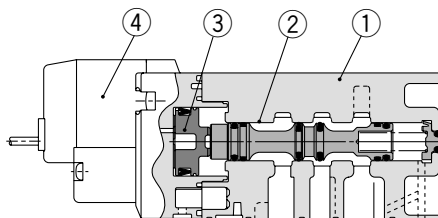
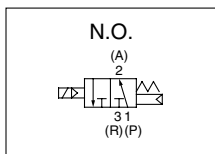
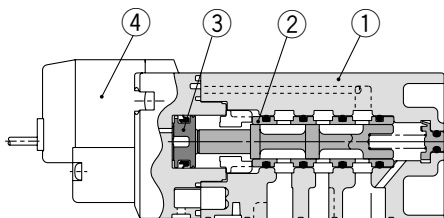
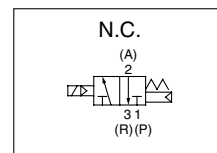
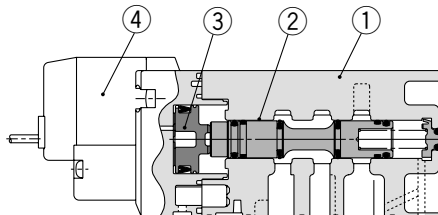

#### Component Parts

No.	Description	Material	Note
1	Body	Aluminum die-casted	
2	Spool, Sleeve	Stainless steel	Metal seal
	Spool valve	Aluminum/HNBR	Rubber seal
3	Piston	Resin	
4	Pilot valve assembly	—	

Note) For "How to Order Pilot Valve Assembly", refer to page 1466.

SYJ  
VQZ  
VP  
VG  
VP3□

# Series VQZ100/200/300

## Dimensions: VQZ100

### Single Unit

Grommet (G): VQZ115□-□G□1-01

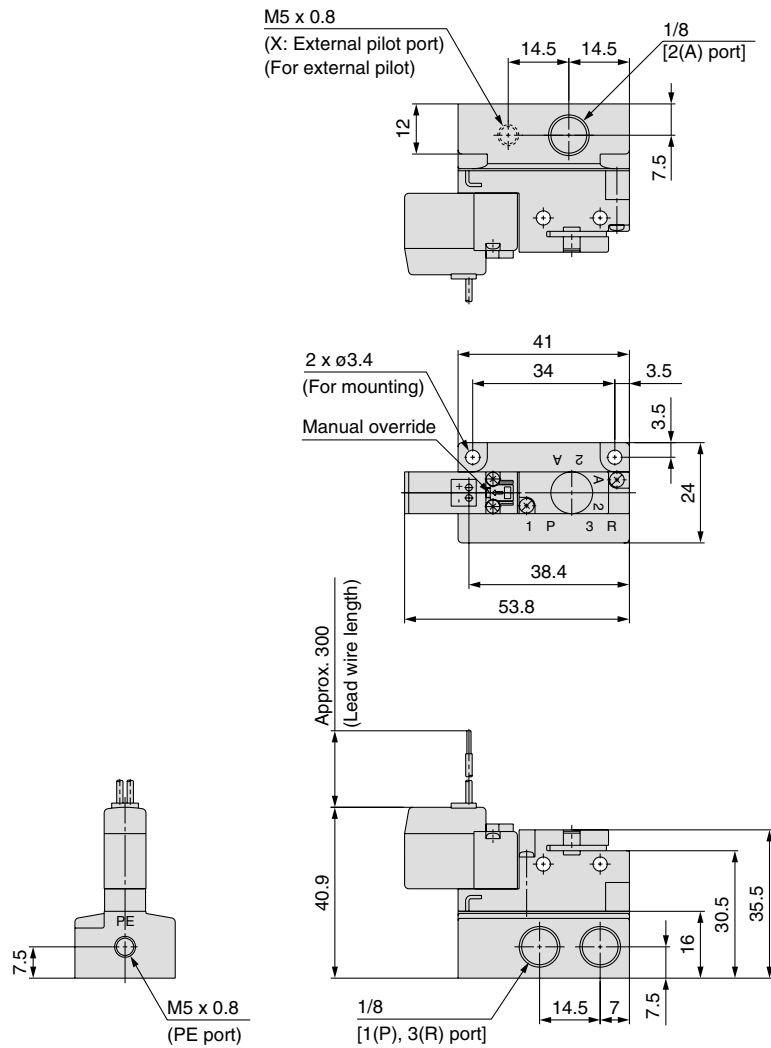

### L-type plug connector (L): VQZ115□-□L□1-01

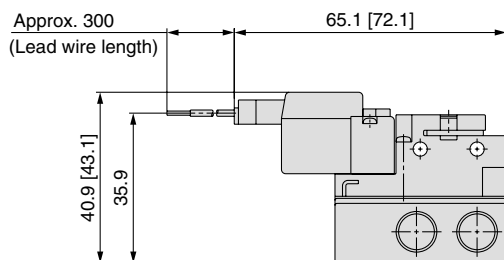

### M-type plug connector (M): VQZ115□-□M□1-01

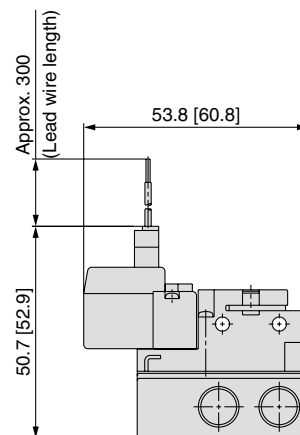

Unless otherwise indicated, dimensions are the same as Grommet (G).  
[ ]: AC

Unless otherwise indicated, dimensions are the same as Grommet (G).  
[ ]: AC



## Dimensions: VQZ200

### Single Unit

Grommet (G): VQZ2□5□-□G□1-01

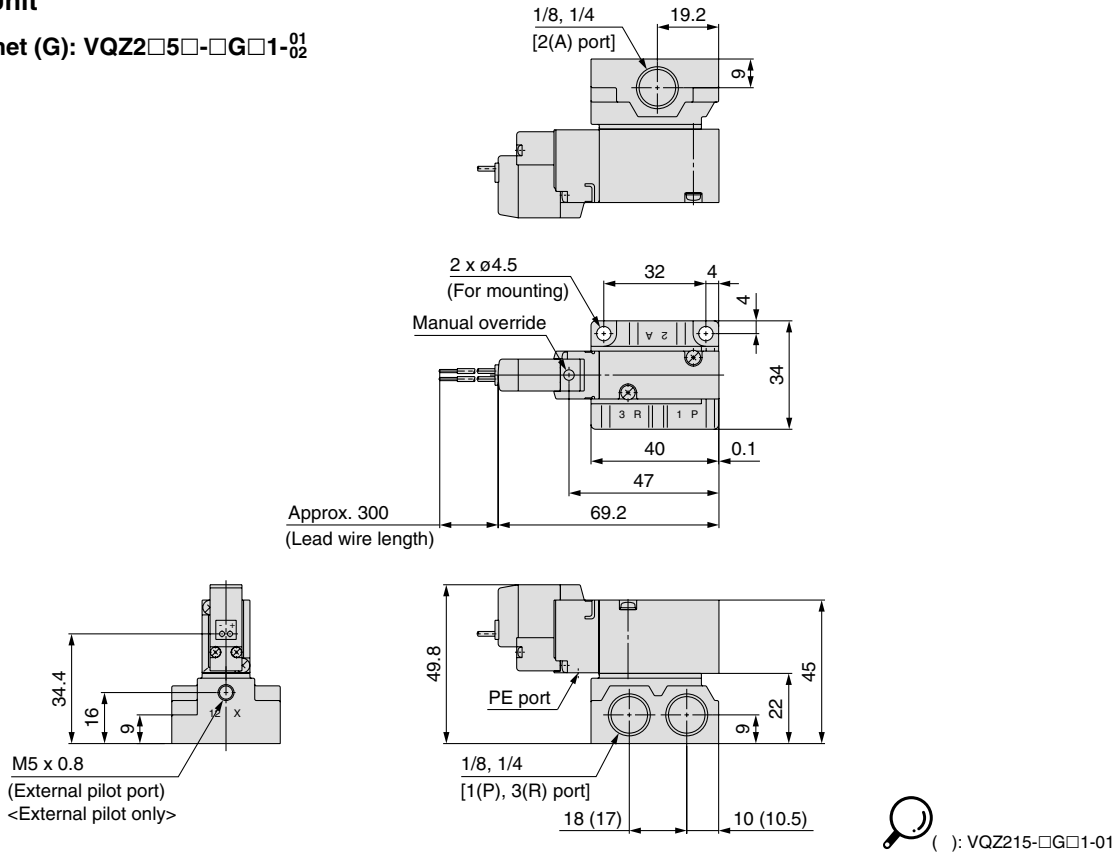

L-type plug connector (L): VQZ2□5□-□L□1-01

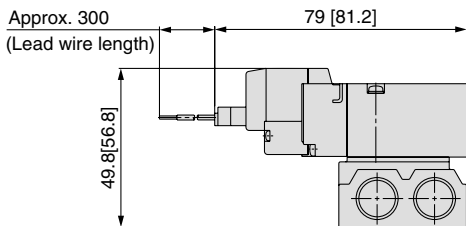

Unless otherwise indicated, dimensions are the same as Grommet (G).  
[ ]: AC

M-type plug connector (M): VQZ2□5□-□M□1-01

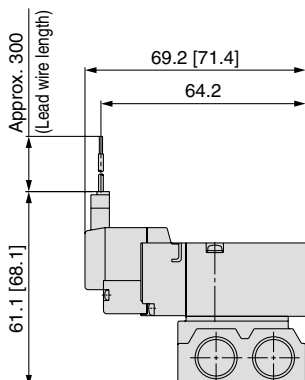

Unless otherwise indicated, dimensions are the same as Grommet (G).  
[ ]: AC

DIN terminal (Y): VQZ2□5□-□Y□1-01

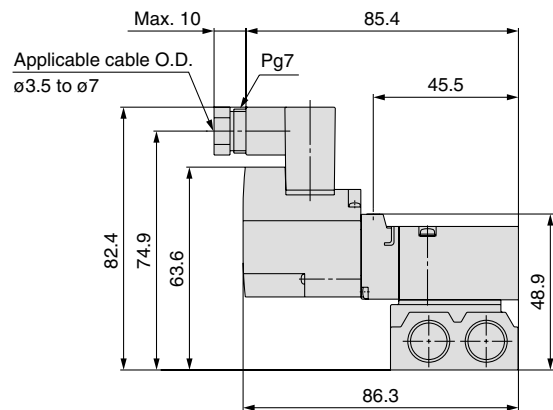

Unless otherwise indicated, dimensions are the same as Grommet (G).  
[ ]: AC

SYJ

VQZ

VP

VG

VP3□

# Series VQZ100/200/300

## Dimensions: VQZ300

### Single Unit

Grommet (G): VQZ3□5□-□G□1- $\frac{02}{03}$

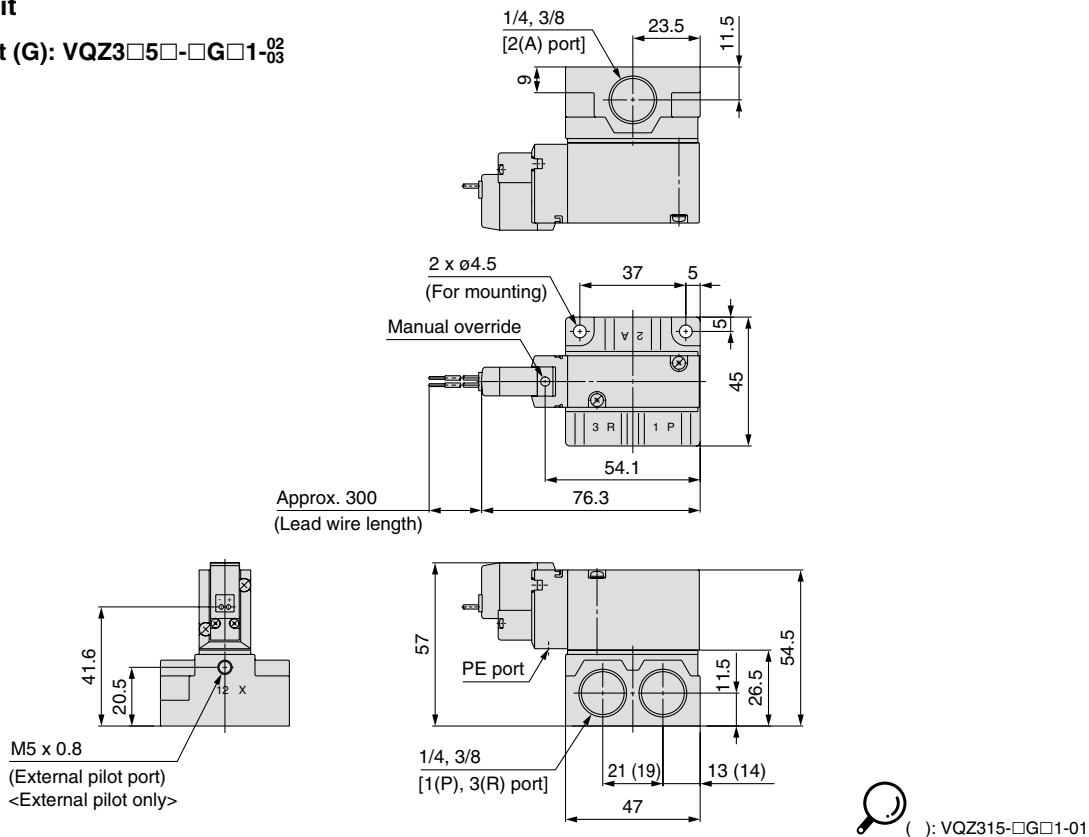

L-type plug connector (L): VQZ3□5□-□L□1- $\frac{02}{03}$

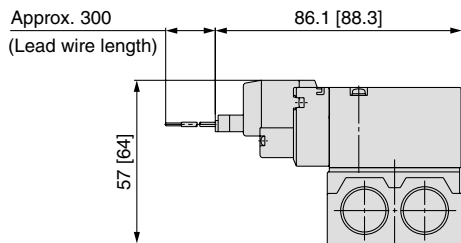

Unless otherwise indicated, dimensions are the same as Grommet (G).  
( ): AC

DIN terminal (Y): VQZ3□5□-□Y□□1- $\frac{02}{03}$

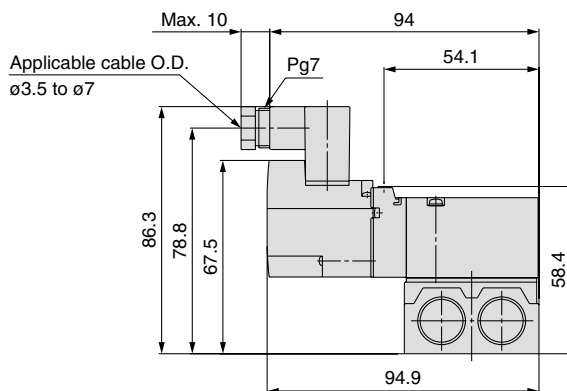

M-type plug connector (M): VQZ3□5□-□M□1- $\frac{02}{03}$

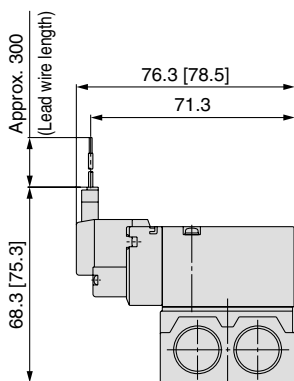

Unless otherwise indicated, dimensions are the same as Grommet (G).  
( ): AC

Unless otherwise indicated, dimensions are the same as Grommet (G).

# 3 Port Solenoid Valve

## Series VQZ100/200/300

### Manifold Connector Kit



### VQZ100 / How to Order Manifold

**VV3QZ 1 5 - 08 C6 C - [ ] - [ ]**

**Series**  
1 VQZ100

**Manifold type**  
5 Base mounted

**Stations**  
02 2 stations  
20 20 stations

**Port size [2(A) port]**

<b>C3</b>	ø3.2 one-touch fitting	For side ported
<b>C4</b>	ø4 one-touch fitting	
<b>C6</b>	ø6 one-touch fitting	
<b>M5</b>	M5 thread (Replaceable type)	For top ported
<b>CP</b> <small>Note 1)</small>	With port plug	
<b>CM</b> <small>Note 2)</small>	Mixed port sizes	—

**CE compliant**

Nil	—
Q	CE compliant

**Option**

Nil	None
D	DIN rail mounting (With standard DIN rail length)
D0 <small>Note)</small>	DIN rail mounting (Without DIN rail)
R	External pilot type

Note 1) Order DIN rail separately.  
For DIN rail part no., refer to page 1464.  
Note 2) When two or more symbols are specified, indicate them alphabetically.

**Kit type**  
C Connector

Note 1) When CP port plug is attached on all 2(A) port. Valve on manifold is top ported.  
Note 2) Specify the mixture port (including top and side piping) by the manifold specification sheet.  
Note 3) For inch size one-touch fittings, refer to page 1465.

### VQZ100 / How to Order Valve

**VQZ 1 1 5 [ ] - 5 M [ ] 1 - C4 - [ ]**

**Series**  
1 VQZ100 body width 10 mm

**Type of actuation**  
1 N.C.

**Body type**  
5 Base mouned

**Function**

Symbol	Specifications	DC	AC
Nil	Standard	(0.35 W) ○	<small>Note 3)</small> ○
K <small>Note 1)</small>	High pressure type	(0.9 W) ○	—
R <small>Note 1, 2)</small>	External pilot type	○	○
KR <small>Note 1, 2)</small>	High pressure/External pilot type	(0.9 W) ○	—

**CE compliant**

Nil	—
Q	CE compliant

Note) For CE compliant models, DC type only.

**Port size**

<b>CP</b>	With port plug	For side ported
<b>C3</b>	ø3.2 one-touch fitting	For top ported
<b>C4</b>	ø4 one-touch fitting	
<b>C6</b>	ø6 one-touch fitting	
<b>M5</b>	M5 thread	

Note) For inch size one-touch fittings, refer to page 1465.

**Manual override**

Nil	Non-locking push type (Tool required)
B	Locking type (Tool required)

**Coil voltage**

1	100 VAC (50/60 Hz)
2	200 VAC (50/60 Hz)
3	110 VAC [115 VAC] (50/60 Hz)
4	220 VAC [230 VAC] (50/60 Hz)
5	24 VDC
6	12 VDC

**Electrical entry**

Symbol	Electrical entry	Light/surge voltage suppressor
G	Grommet (DC specification)	None
L	L-plug plug connector with lead wire	Yes
LO	L-plug plug connector without connector	
M	M-plug plug connector with lead wire	
MO	M-plug plug connector without connector	

Note) Standard lead wire length: 300 mm

**Caution**  
Use standard (DC) specification for continuous duty.

SYJ  
VQZ  
VP  
VG  
VP3□

# Series VQZ100/200/300

## VQZ200/300 / How to Order Manifold



Made to Order  
(For details, refer to page 1467.)

**VV3QZ** **2** **5** - **08** **C6** **C** - **□** - **□**

**Series**

2	VQZ200
3	VQZ300

**Manifold type**

5	Base mounted
---	--------------

**Stations**

02	2 stations
⋮	⋮
20	20 stations

**Port size [2(A) port]**

Symbol	Port size	VQZ200	VQZ300
C4	ø4 one-touch fitting	○	—
C6	ø6 one-touch fitting	○	○
C8	ø8 one-touch fitting	○	○
C10	ø10 one-touch fitting	—	○
01	Rc 1/8	○	—
02	Rc 1/4	—	○
CM <sup>Note 1)</sup>	Mixed port sizes	○	○

**CE compliant**

Nil	—
Q	CE compliant

**Option**

Nil	None
D	DIN rail mounting (With standard DIN rail length)
D0 <sup>Note)</sup>	DIN rail mounting (Without DIN rail)
R	External pilot type

**Kit type**

C	Connector
---	-----------

Note 1) Specify port mixture/with port plug by means of the manifold specification sheet. Port mixture and port plug are available only for one-touch fitting type.  
Note 2) When two or more symbols are specified, indicate them alphabetically.

## VQZ200/300 / How to Order Valve

**VQZ** **2** **1** **5** - **5** **M** **□** **1** - **□**

**Series**

2	VQZ200 body width 15 mm
3	VQZ300 body width 18 mm

**Type of actuation**

1	N.C. Metal seal
2	N.O. Metal seal
3	N.C. Rubber seal
4	N.O. Rubber seal

**Body type**

5	Base mouned
---	-------------

**Function**

Symbol	Specifications	DC	AC
Nil	Standard	(0.35 W) ○ <sup>Note 3)</sup>	○
B <sup>Note 1)</sup>	High speed response type	(0.9 W) ○	—
K <sup>Note 1)</sup>	High pressure type (Metal seal type only)	(0.9 W) ○	—
R <sup>Note 1, 2)</sup>	External pilot type	○	○
BR <sup>Note 1, 2)</sup>	High speed response/External pilot type	(0.9 W) ○	—
KR <sup>Note 1, 2)</sup>	High pressure/External pilot type (Metal seal type only)	(0.9 W) ○	—

**CE compliant**

Nil	—
Q	CE marked

Note) AC-type models that are CE compliant have DIN terminals only.

**IP65 compliant**

Nil	—
W <sup>Note)</sup>	CE compliant

Note) VQZ200/300 DIN terminal rubber seal only (except external pilot). For details on IP65 enclosure, refer to page 1465.

**Manual override**

Nil	Non-locking push type (Tool required)
B	Locking type (Tool required)

**Electrical entry**

Symbol	Electrical entry	Light/surge voltage suppressor
G	Grommet (DC specification)	None
L	L-type plug connector with lead wire	Yes
LO	L-type plug connector without connector	
M	M-type plug connector with lead wire	
MO	M-type plug connector without connector	None
Y	DIN terminal	
YO	DIN terminal without connector	
YZ	DIN terminal	Yes
YS <sup>Note 2)</sup>	DIN terminal (DC specification)	Yes
YOS <sup>Note 2)</sup>	DIN terminal without connector (DC specification)	(Without light)

Note 1) Standard lead wire length: 300 mm  
Note 2) For AC voltage valves there is no "S" option. It is already built-in to the rectifier circuit.

**Coil voltage**

1	100 VAC (50/60 Hz)
2	200 VAC (50/60 Hz)
3	110 VAC [115 VAC] (50/60 Hz)
4	220 VAC [230 VAC] (50/60 Hz)
5	24 VDC
6	12 VDC

Note 1) Option  
Note 2) For details on external pilot type, refer to page 1465.  
Note 3) For AC specification power consumption, refer to page 1452.

**Caution**  
Use standard (DC) specification for continuous duty.

## Manifold Specifications



Series	Base model	Piping specifications			Applicable solenoid valve	Applicable stations	Manifold base mass (g) <sup>Note)</sup>
		Piping direction	Port size				
			1(P), 3(R)	2(A)			
VQZ100	VV3QZ15-□□□	Side/Top	Rc 1/8	C3 (for ø3.2) C4 (for ø4) C6 (for ø6) M5 (M5 thread)	VQZ115	2 to 20 stations	2 stations: 83 Addition per station: 19
VQZ200	VV3QZ25-□□□	Side	Rc 1/4	C4 (for ø4) C6 (for ø6) C8 (for ø8) Rc 1/8	VQZ2□5	2 to 20 stations	2 stations: 126 Addition per station: 38
VQZ300	VV3QZ35-□□□	Side	1(P) port Rc 3/8 3(R) port Rc 1/4	C6 (for ø6) C8 (for ø8) C10 (for ø10) Rc 1/4	VQZ3□5	2 to 20 stations	2 stations: 209 Addition per station: 60

Note) Mass for threaded connection.

## How to Order Manifold Assembly (Example)

VV3QZ25-05C6C ... 1 set (C kit 5-station manifold base part no.)

\* VVQZ200-10A-5 ... 1 set (Blanking plate assembly part no.)

\* VQZ215-5L1 ..... 4 sets (N.C. type part no.)

→ The asterisk denotes the symbol for assembly. Prefix it to the part nos. of the solenoid valve, etc.

→ Enter in order starting from the first station on the D side.

Add the valve and option part number under the manifold base part number.  
When entry of part numbers becomes complicated, indicate by the manifold specification sheet.

SYJ

VQZ

VP

VG

VP3□

# Series VQZ100/200/300

## Dimensions: VQZ100: Top Ported

VV3QZ15- Stations Port size C

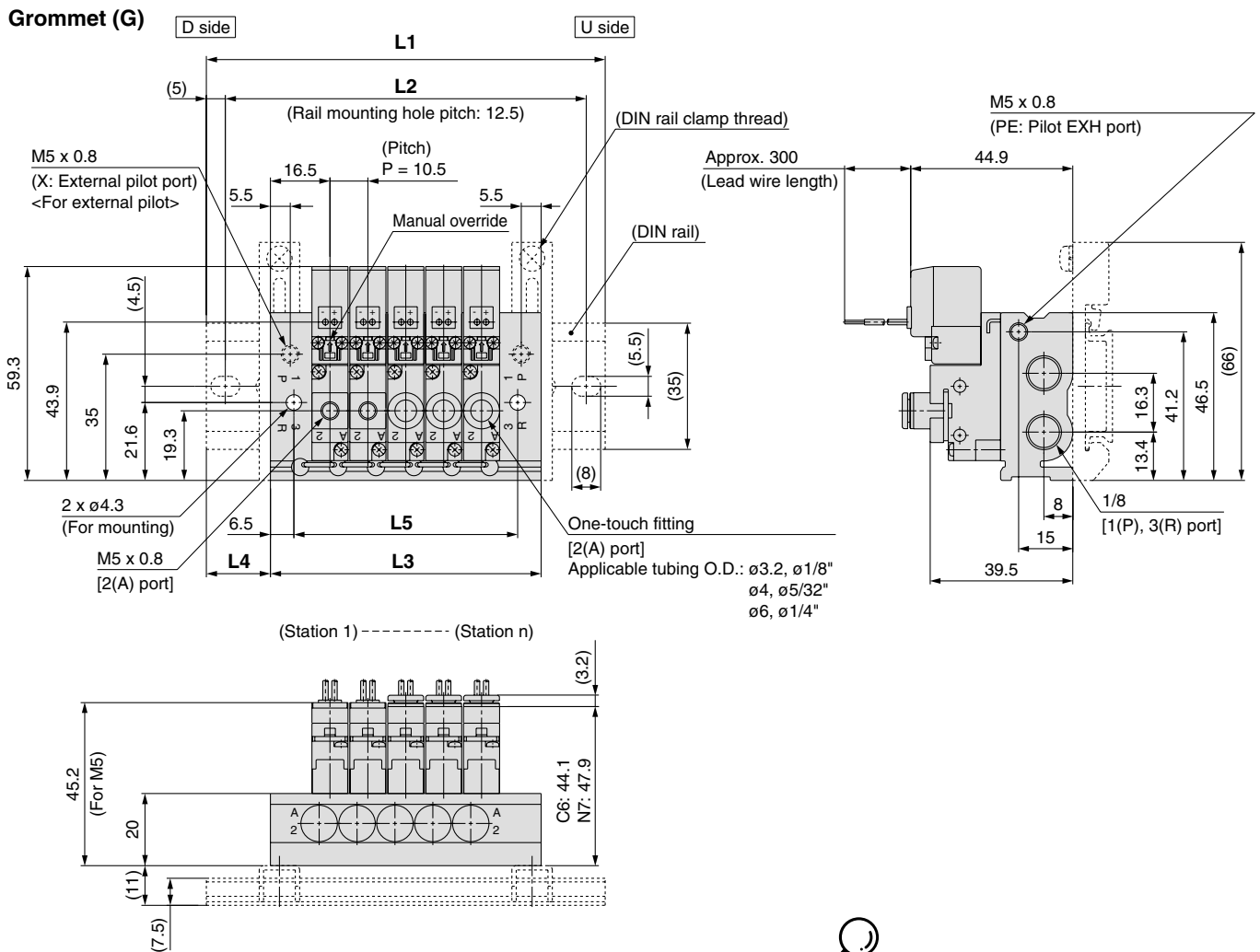

### M5

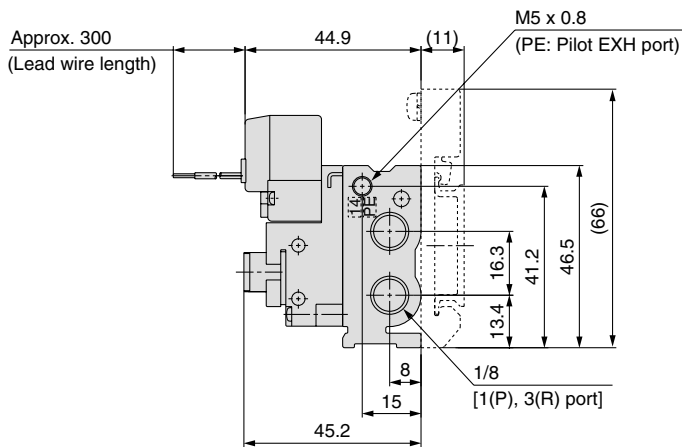

### Dimensions

Formula:  $L5 = 10.5n + 9.5$      $L3 = 10.5n + 22.5$     n: Stations (Max. 20 stations)

L \ n	2	3	4	5	6	7	8	9	10	11	12	13	14	15	16	17	18	19	20
<b>L1</b>	85.5	85.5	98	110.5	123	135.5	148	148	160.5	173	185.5	198	210.5	210.5	223	235.5	248	260.5	273
<b>L2</b>	75	75	87.5	100	112.5	125	137.5	137.5	150	162.5	175	187.5	200	200	212.5	225	237.5	250	262.5
<b>L3</b>	43.5	54	64.5	75	85.5	96	106.5	117	127.5	138	148.5	159	169.5	180	190.5	201	211.5	222	232.5
<b>L4</b>	21	16	17	18	19	20	21	15.5	16.5	17.5	18.5	19.5	20.5	15.5	16.5	17.5	18.5	19.5	20.5
<b>L5</b>	30.5	41	51.5	62	72.5	83	93.5	104	114.5	125	135.5	146	156.5	167	177.5	188	198.5	209	219.5

## Dimensions: VQZ100: Side Ported

VV3QZ15- Stations Port size C

Grommet (G)

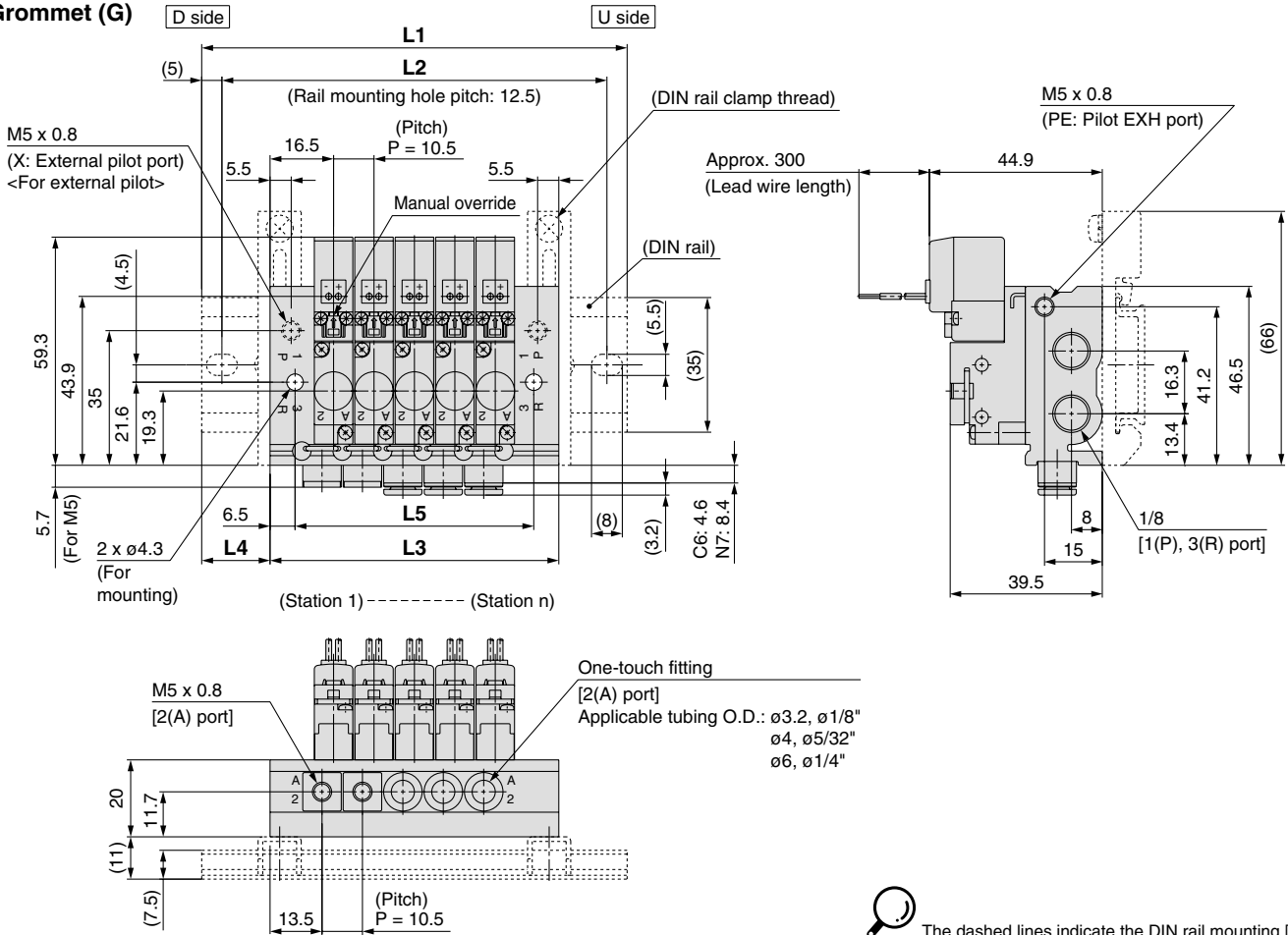

The dashed lines indicate the DIN rail mounting [-D].

### L-type plug connector (L)

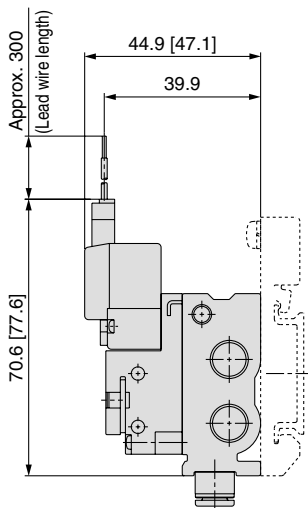

Unless otherwise indicated, dimensions are the same as Grommet (G).  
[ ]: AC

### M-type plug connector (M)

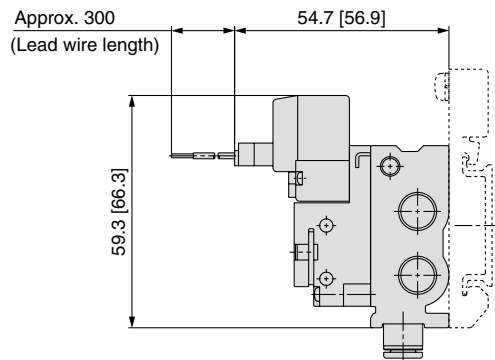

Unless otherwise indicated, dimensions are the same as Grommet (G).  
[ ]: AC

### Dimensions

Formula: L5 = 10.5n + 9.5 L3 = 10.5n + 22.5 n: Stations (Max. 20 stations)

n	2	3	4	5	6	7	8	9	10	11	12	13	14	15	16	17	18	19	20
L1	85.5	85.5	98	110.5	123	135.5	148	148	160.5	173	185.5	198	210.5	210.5	223	235.5	248	260.5	273
L2	75	75	87.5	100	112.5	125	137.5	137.5	150	162.5	175	187.5	200	200	212.5	225	237.5	250	262.5
L3	43.5	54	64.5	75	85.5	96	106.5	117	127.5	138	148.5	159	169.5	180	190.5	201	211.5	222	232.5
L4	21	16	17	18	19	20	21	15.5	16.5	17.5	18.5	19.5	20.5	15.5	16.5	17.5	18.5	19.5	20.5
L5	30.5	41	51.5	62	72.5	83	93.5	104	114.5	125	135.5	146	156.5	167	177.5	188	198.5	209	219.5

# Series VQZ100/200/300

## Dimensions: VQZ200

VV3QZ25- Stations Port size C

### Grommet (G)

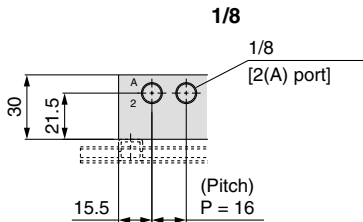
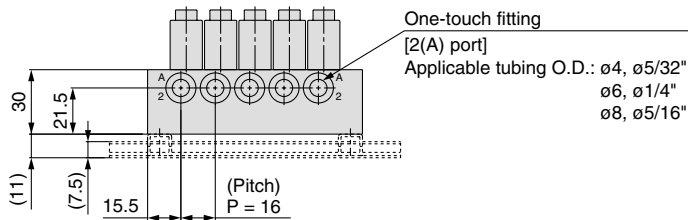
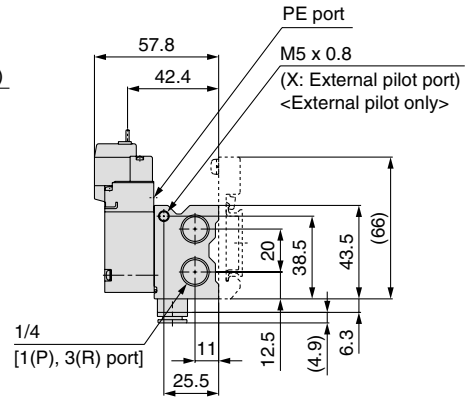
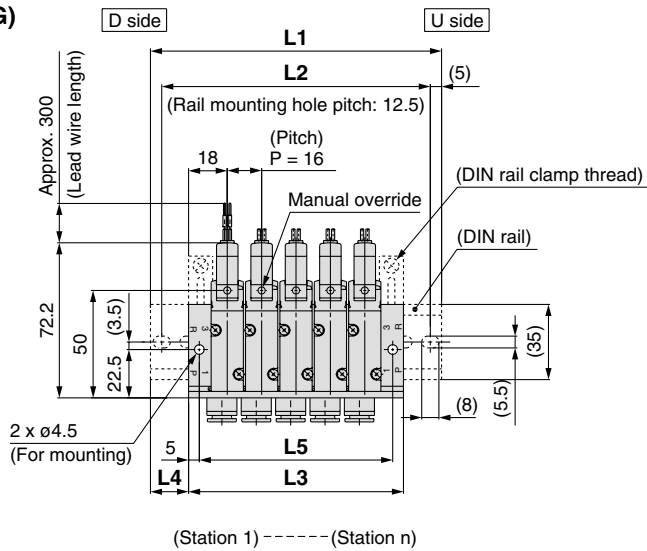

The dashed lines indicate the DIN rail mounting [-D].

### L-type plug connector (L)

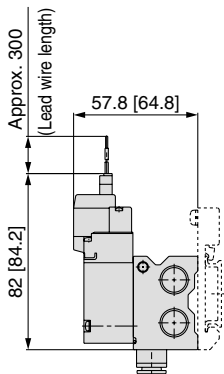

Unless otherwise indicated, dimensions are the same as Grommet (G).  
[ ]: AC

### M-type plug connector (M)

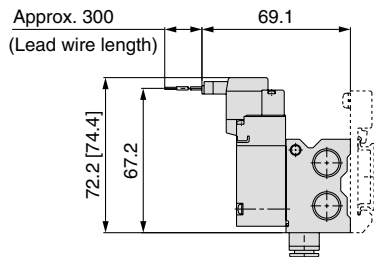

Unless otherwise indicated, dimensions are the same as Grommet (G).  
[ ]: AC

### DIN terminal (Y)

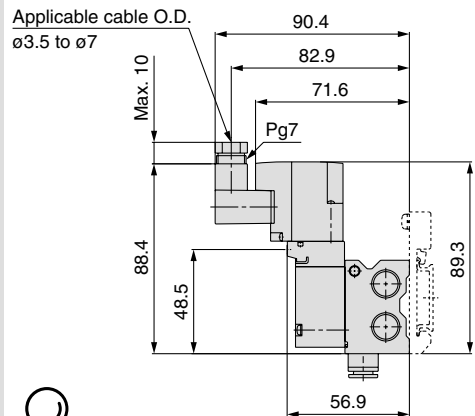

Unless otherwise indicated, dimensions are the same as Grommet (G).

### Dimensions

Formula:  $L5 = 16n + 10$   $L3 = 16n + 20$  n: Stations (Max. 20 stations)

L \ n	2	3	4	5	6	7	8	9	10	11	12	13	14	15	16	17	18	19	20
L1	85.5	98	123	135.5	148	173	185.5	198	210.5	235.5	248	260.5	285.5	298	310.5	323	348	360.5	373
L2	75	87.5	112.5	125	137.5	162.5	175	187.5	200	225	237.5	250	275	287.5	300	312.5	337.5	350	362.5
L3	52	68	84	100	116	132	148	164	180	196	212	228	244	260	276	292	308	324	340
L4	17	15	19.5	18	16	20.5	19	17	15.5	20	18	16.5	21	19	17.5	15.5	20	18.5	16.5
L5	42	58	74	90	106	122	138	154	170	186	202	218	234	250	266	282	298	314	330



## Dimensions: VQZ300

VV3QZ35- Stations Port size C

### Grommet (G)

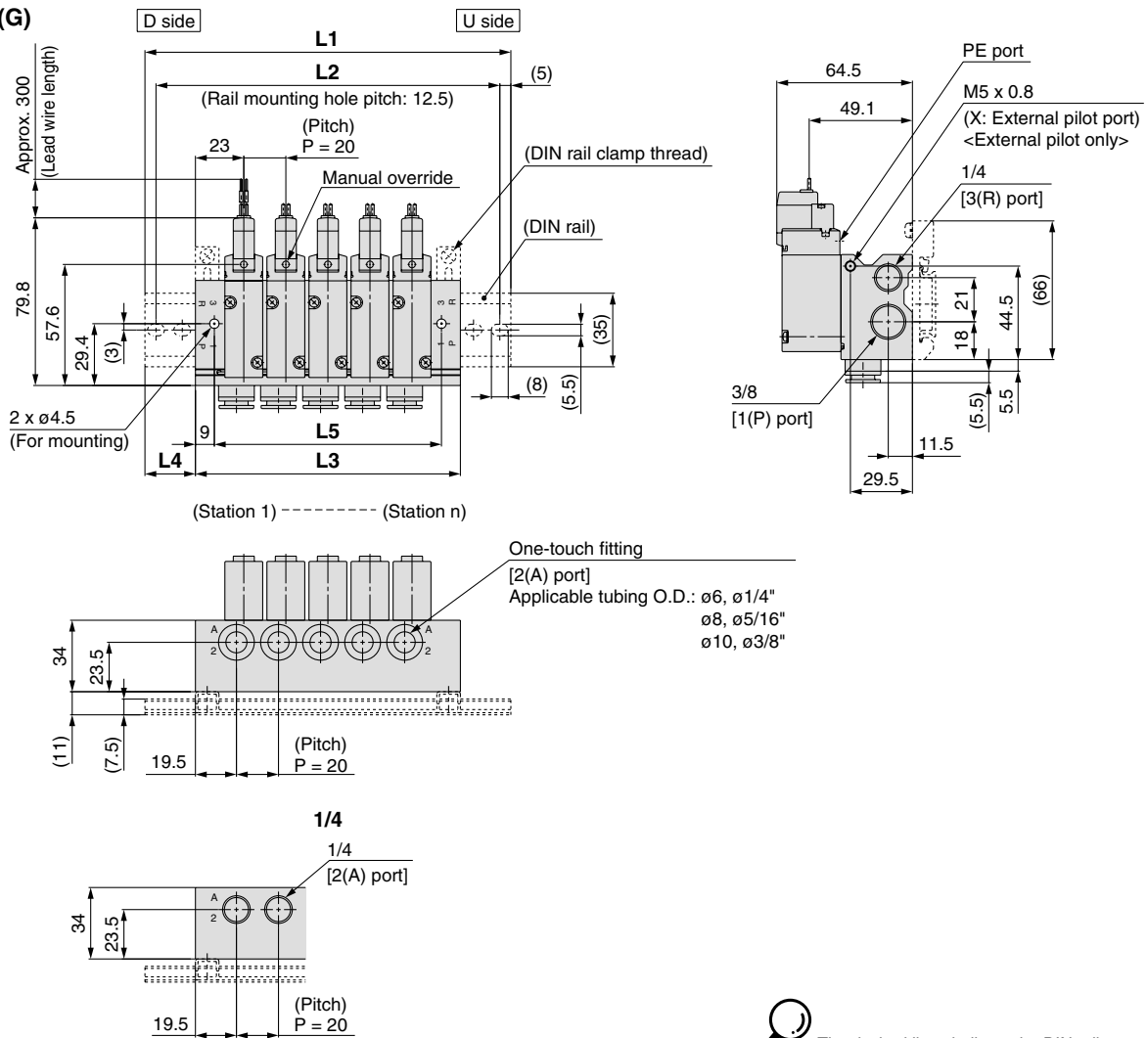

The dashed lines indicate the DIN rail mounting [-D].

### L-type plug connector (L)

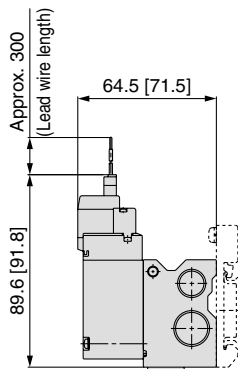

Unless otherwise indicated, dimensions are the same as Grommet (G).  
[ ]: AC

### M-type plug connector (M)

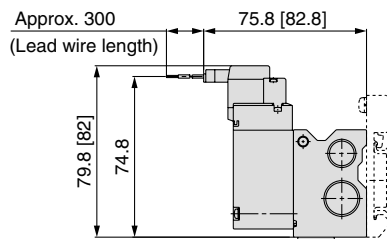

Unless otherwise indicated, dimensions are the same as Grommet (G).  
[ ]: AC

### DIN terminal (Y)

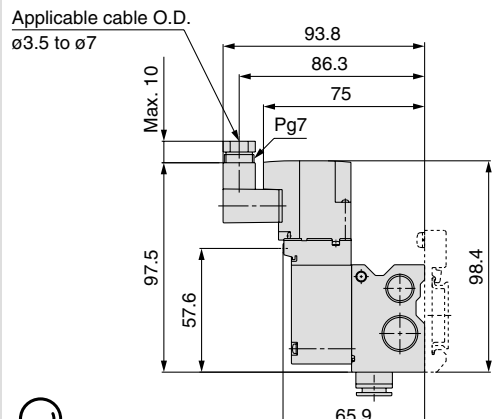

Unless otherwise indicated, dimensions are the same as Grommet (G).

### Dimensions

Formula:  $L5 = 20n + 8$   $L3 = 20n + 26$  n: Stations (Max. 20 stations)

L \ n	2	3	4	5	6	7	8	9	10	11	12	13	14	15	16	17	18	19	20
L1	98	123	148	160.5	185.5	198	223	248	260.5	285.5	298	323	348	360.5	385.5	398	423	448	460.5
L2	87.5	112.5	137.5	150	175	187.5	212.5	237.5	250	275	287.5	312.5	337.5	350	375	387.5	412.5	437.5	450
L3	66	86	106	126	146	166	186	206	226	246	266	286	306	326	346	366	386	406	426
L4	16	18.5	21	17.5	20	16	18.5	21	17.5	20	16	18.5	21	17.5	20	16	18.5	21	17.5
L5	48	68	88	108	128	148	168	188	208	228	248	268	288	308	328	348	368	388	408

# Series VQZ100/200/300

## Manifold Options

### Blanking plate assembly

VVQZ100-10A-5 (for VQZ100)

VVQZ200-10A-5 (for VQZ200)

VVQZ300-10A-5 (for VQZ300)

It is used by attaching on the manifold block for being prepared for removing a valve for maintenance reasons or planning to mount a spare valve, etc.

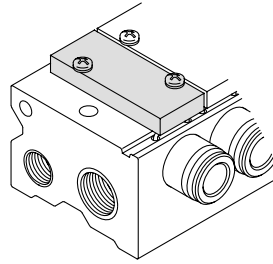

### Blanking plug

KQ2P-23

KQ2P-04

KQ2P-06

KQ2P-08

KQ2P-10

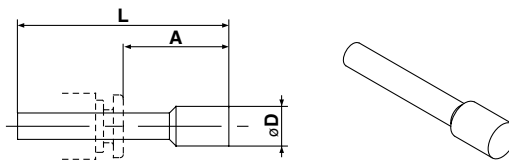

#### Dimensions

Applicable fitting size ød	Model	A	L	D
3.2	KQ2P-23	16	31.5	3.2
4	KQ2P-04	16	32	6
6	KQ2P-06	18	35	8
8	KQ2P-08	20.5	39	10
10	KQ2P-10	22	43	12

### DIN rail

AXT100-DR-□

\* As for □, enter the number from the DIN rail dimensions table.  
For L dimension, refer to the dimensions of each kit.

Each manifold can be mounted on a DIN rail.  
Insert "D" at the end of the manifold part number.  
The DIN rail is approximately 30 mm longer than the length of manifold.

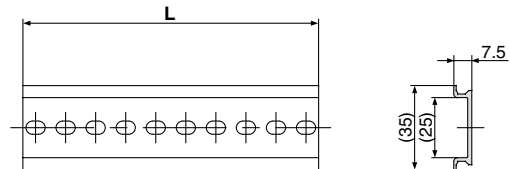

#### L Dimension

$$L = 12.5n + 10.5$$

No.	1	2	3	4	5	6	7	8	9	10	11	12	13	14	15	16	17	18	19	20
L dimension	23	35.5	48	60.5	73	85.5	98	110.5	123	135.5	148	160.5	173	185.5	198	210.5	223	235.5	248	260.5
No.	21	22	23	24	25	26	27	28	29	30	31	32	33	34	35	36	37	38	39	40
L dimension	273	285.5	298	310.5	323	335.5	348	360.5	373	385.5	398	410.5	423	435.5	448	460.5	473	485.5	498	510.5

### Silencer

(for manifold EXH port)

Silencer is installed in the manifold EXH port.

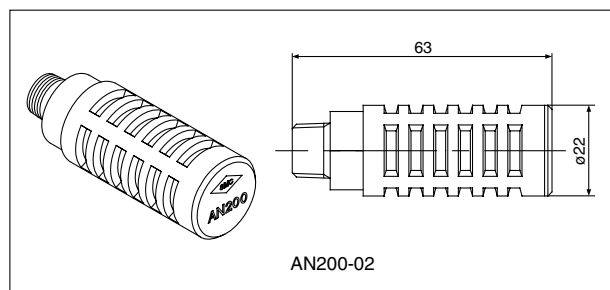
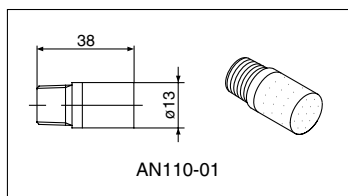

#### Dimensions

Model	Silencer part no.
VQZ100	AN110-01
VQZ200	AN200-02
VQZ300	AN200-02

### Port plug

VVQZ100-CP (for VQZ100)

This is used when changing piping location. (Side or Top)

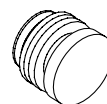

# Series VQZ Base Mounted

## Options

### External Pilot Specification

The external pilot specification is used when the operating pressure is below the minimum operating pressure 0.1 to 0.15 MPa or when valve is used for a vacuum application. Order a valve by adding the external pilot specification [R] to the part number.

Valve Part No.

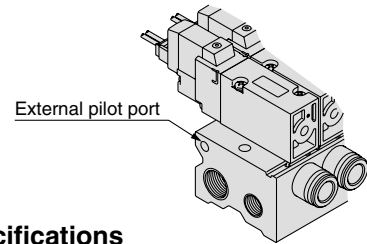
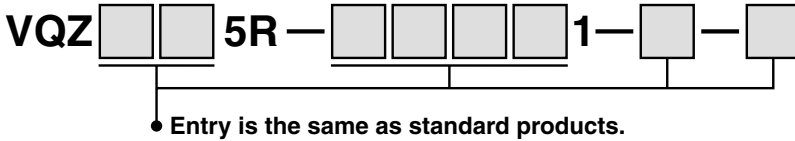

Manifold Part No.

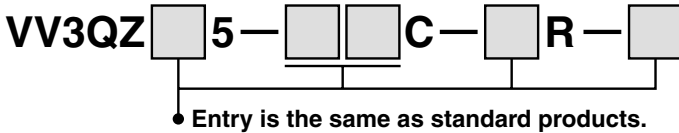

### Pressure Specifications

Series		VQZ100 <sup>Note 2)</sup>	VQZ200/300
External pilot pressure range <sup>Note 1)</sup>	Metal seal	—	0.1 to 0.7 MPa
	Rubber seal (VQZ100: poppet)	0.2 to 0.7 MPa	0.15 to 0.7 MPa
Operating pressure range <sup>Note 1)</sup>		-100 kPa to 0.7 MPa	

Note 1) In case of the high pressure type, upper limit of max. operating pressure and external pilot pressure range is 1 MPa.

Note 2) When using the VQZ100 series for a vacuum application, vacuum air through its 1(P) port. When supplying vacuum-release air, supply it through its 3(R) port. But do not supply vacuum-release air exceeding 50% for the external pilot pressure.

### Inch Size One-touch Fittings and Optional Threads

Inch size one-touch fittings and NPT, NPTF and G thread are available.

Manifold Part No.

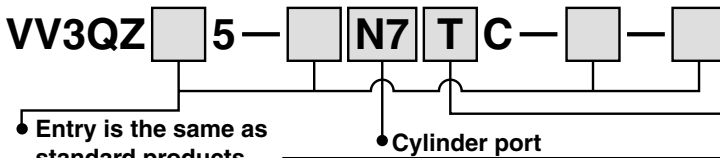

Symbol	N1	N3	N7	N9	N11	NM <sup>Note 1)</sup>	M5	01	02
Applicable tubing O.D.	ø1/8"	ø5/32"	ø1/4"	ø5/16"	ø3/8"	Mixed	M5 thread	1/8 thread	1/4 thread
Cylinder port	VQZ100	●	●	●	—	●	●	—	—
	VQZ200	—	●	●	●	●	—	●	—
	VQZ300	—	—	●	●	●	—	—	●

Nil	Rc
N	NPT
T	NPTF
F	G

Note 1) Except VQZ100, mixing one-touch fittings and thread types is impossible.

Note 2) Metric size one-touch fittings (C□) are also available.

### Optional Threads Other than Rc

Rc specifications are standard for all ports, however, NPT, NPTF and G are available for overseas markets. Add the appropriate symbol following the port size in the standard part number.

Valve Part No.

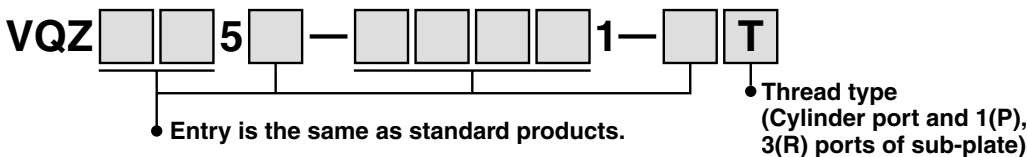

Nil	Rc
N	NPT
T	NPTF
F	G

SYJ

VQZ

VP

VG

VP3□

### IP65 Enclosure (Based on IEC60529)

DIN terminal is available with IP65 enclosure.

Valve Part No.

(Applicable to the VQZ200/300 rubber seal with the exception of the external pilot type)

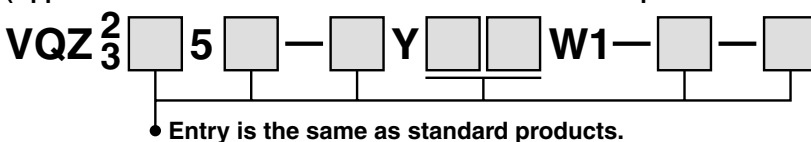

Note) The pilot exhaust IP65 valves is common with main valve exhaust. (The standard valve has an individual exhaust for the pilot valve.)

# Replacement Parts

## One-touch Fitting Assembly (for Cylinder port)

Fitting size	C3	C4	C6	C8	C10	M5 (VQZ100 only)
<b>VQZ100</b>	VVQ1000-50A-C3	VVQ1000-50A-C4	VVQ1000-50A-C6	—	—	VVQ1000-50A-M5
<b>VQZ200</b>	—	VVQ1000-51A-C4	VVQ1000-51A-C6	VVQ1000-51A-C8	—	—
<b>VQZ300</b>	—	—	VVQ2000-51A-C6	VVQ2000-51A-C8	VVQ2000-51A-C10	—

Note) Purchasing order is available in units of 10 pieces.

### <Plug connector assembly>

DC: SY100-30-4A-

100 VAC: SY100-30-1A-

200 VAC: SY100-30-2A-

Other AC voltages: SY100-30-3A-

Without lead wire: SY100-30-A  
(with connector and 2 sockets only)

#### Lead wire length

Lead wire length	Part no.
Nil	300 mm
6	600 mm
10	1000 mm
15	1500 mm
20	2000 mm
25	2500 mm
30	3000 mm
50	5000 mm

### How to Order

Include the connector assembly part number together with the part number for the plug connector's solenoid valve without connector.

Example) In case of 2000 mm of lead wire

DC	AC
VQZ115-5LO1-M5	VQZ115-1LO1-M5
SY100-30-4A-20	SY100-30-1A-20

### <Gasket and screw assembly>

Model	Part no.
<b>VQZ100</b>	VQZ100-GS-5
<b>VQZ200</b>	VQZ200-GS-5
<b>VQZ300</b>	VQZ300-GS-5

Note) Above part number consists of 10 units. Each unit has one gasket and two screws. Purchasing order is available in units of 10 pieces.

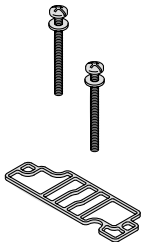

### <Sub-plate>

Model	Sub-plate part no.
<b>VQZ100</b>	VQZ100-S-01(R) (S) (-Q) (Note)
<b>VQZ200</b>	VQZ200-S-01 (S) (-Q)
<b>VQZ300</b>	VQZ300-S-02 (S) (-Q)

\* Thread type  
Note) R indicates external pilot type. Except VQZ100, external pilot type and internal pilot type are common.

### <Pilot valve assembly>

V111 [ ] [ ] - 5 G [ ]

Symbol	Specifications	Function	
		DC	AC
Nil	Standard	(0.35 W) ○	○
B (Note)	High speed response type (Applicable to VQZ200/300)	(0.9 W) ○	—
K (Note)	High pressure type (Applicable to Metal seal type, Poppet seal type)	(0.9 W) ○	—

Note) Option

#### Manual override

Nil	None (Applicable to VQZ200/300)
M	Yes (Applicable to VQZ100)

#### Manual override (Applicable to the VQZ100)

Nil	Non-locking push type
B	Locking slotted type

#### Coil voltage

1	100 VAC (50/60 Hz)
2	200 VAC (50/60 Hz)
3	110 VAC (50/60 Hz)
4	220 VAC (50/60 Hz)
5	24 VDC
6	12 VDC

#### Electrical entry

Symbol	Electrical entry		Light/surge voltage suppressor
	DC	AC	
G	—	Grommet (DC specification)	None
LU	LZ	L-type plug connector with lead wire	Yes
LOU	LOZ	L-type plug connector without connector	
MU	MZ	M-type plug connector with lead wire	
MOU	MOZ	M-type plug connector without connector	

Note) The electrical entry (L, M) for the VQZ100 pilot valve is different from that of the main valve model number.

Valve model	Pilot valve model
VQZ115 [ ] - [ ] L [ ] 1	V111 [ ] M - [ ] M [ ]
VQZ115 [ ] - [ ] M [ ] 1	V111 [ ] M - [ ] L [ ]

### <DIN terminal type (Applicable to the VQZ200/300)>

V115 [ ] - 5 Y - X110

Symbol	Specifications	Function	
		DC	AC
Nil	Standard	(0.35 W) ○	○
B (Note)	High speed response type	(0.9 W) ○	—
K (Note)	High pressure type (Metal seal type only)	(0.9 W) ○	—

Note) Option

#### Coil voltage

1	100 VAC (50/60 Hz)
2	200 VAC (50/60 Hz)
3	110 VAC (50/60 Hz)
4	220 VAC (50/60 Hz)
5	24 VDC
6	12 VDC

#### Electrical entry

Symbol	Electrical entry		Light/surge voltage suppressor
	DC	AC	
Y	—	DIN terminal	None
YO	—	DIN terminal without connector	
YZ	—	DIN terminal with light/surge voltage suppressor	Yes
YS (Note)	—	DIN terminal with surge voltage suppressor (DC specification)	Yes (Without light)
YOS (Note)	—	DIN terminal with surge voltage suppressor, without connector (DC specification)	

Note) For AC voltage valves there is no "S" option. It is already built-in to the rectifier circuit.

### ⚠ Caution

When replacing only the pilot valve assembly, use caution because it is not possible to convert to a V115 (DIN terminal) from a V111 (Grommet, L-type, M-type), or vice versa.

# Series VQZ200/300

## Made to Order

Please contact SMC for detailed dimensions, specifications, and lead times.



### 1 Pilot Valve Common Exhaust Specification

Pilot exhaust is exhausted through the main R port.

- \* Not designed to prevent leakage to outside.
- \* A combination of external pilots is not available.
- \* "How to Order Manifold" is the same as standard products. Please specify this to "How to Order Valve."

Applicable solenoid valve series: VQZ200/300

#### How to Order

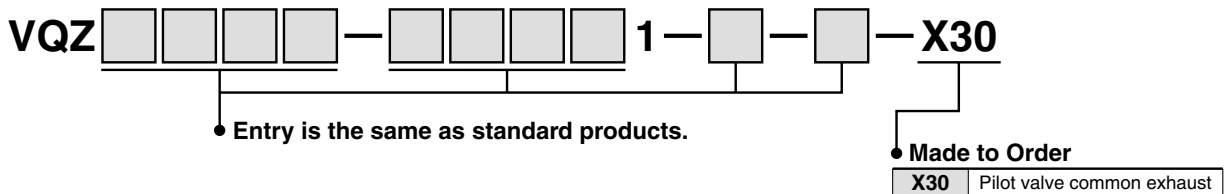

### 2 Main Valve Fluoro-rubber Specification

The seal material, the part of the main valve in contact with fluid, is made of fluoro-rubber.

- \* "How to Order Manifold" is the same as standard products. Please specify this to "How to Order Valve."

Applicable solenoid valve series: VQZ200/300

#### How to Order

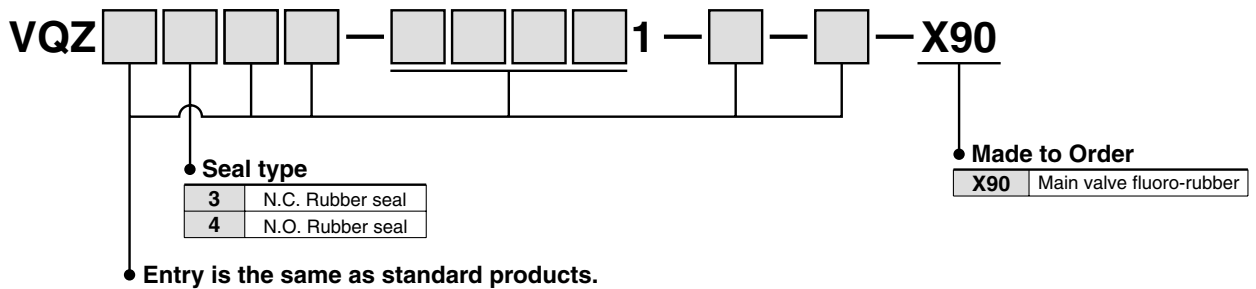

### 3 All Fluoro-rubber Specification

The rubber material of the part in contact with fluid, is made of fluoro-rubber.

- \* "How to Order Manifold" is the same as standard products. Please specify this to "How to Order Valve."

Applicable solenoid valve series: VQZ200/300

#### How to Order

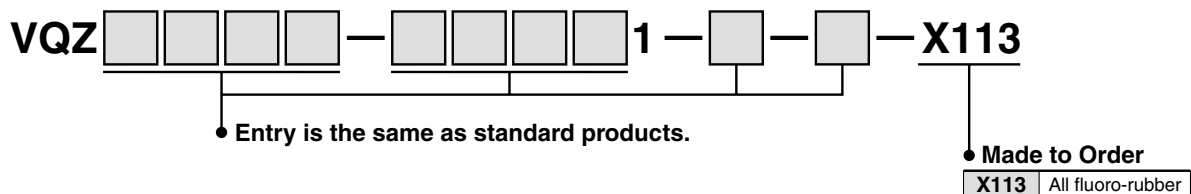

SYJ

VQZ

VP

VG

VP3□



# Series VQZ Specific Product Precautions 1

Be sure to read before handling.

Refer to front matters 58 and 59 for Safety Instructions and pages 3 to 7 for 3/4/5 Port Solenoid Valve Precautions.

## Manual Override

### ⚠ Caution

Without an electric signal for the solenoid valve the manual override is used for switching the main valve. Push type is standard. Locking type (Tool required) is available as an option.

#### 1. VQZ100

##### Push type

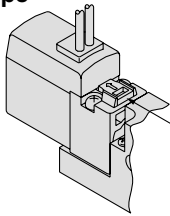

Press in the direction of the arrow.

##### Locking type (Tool required)

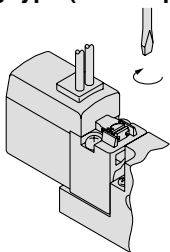

Turn 90° in the direction of arrow.

#### 2. VQZ200/300

##### Push type (Tool required)

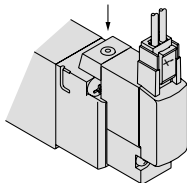

Push down on the manual override button with a small screwdriver until it stops. Release the screwdriver and the manual override will return.

##### Locking type (Tool required)

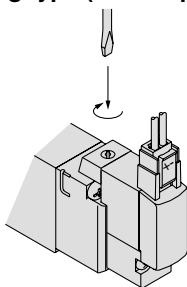

Push down completely on the manual override button with a small screwdriver. While down, turn clockwise 90° to lock it. Turn it counterclockwise to release it.

##### Locked position

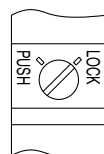

### Precautions

When operating with a screwdriver, turn it gently using a watchmaker's screwdriver. (Torque: less than 0.1 N·m)  
Press and rotate to lock the manual operation of VQZ200/300. If rotate without pressing, manual breakage and air leakage could be occurred.

## How to Use L/M-Type Plug Connector

### ⚠ Caution

#### 1. Attaching and detaching connectors

To attach a connector, hold the lever and connector unit between your fingers and insert straight onto the pins of the solenoid valve and remove the pawl from the groove by pushing the lever downward with your thumb, and pull the connector straight out.

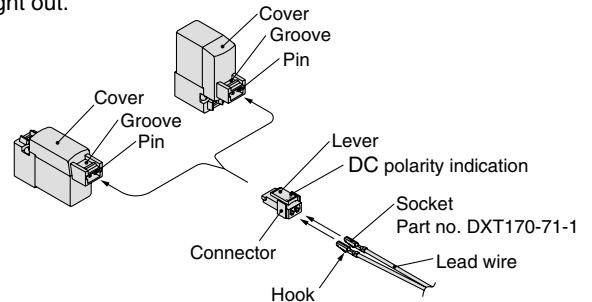

## Light/Surge Voltage Suppressor

### ⚠ Caution

#### 1. L/M-type plug connector

<DC>

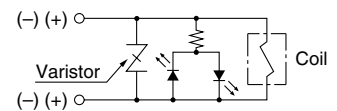

<AC>

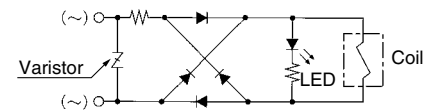

#### 2. DIN terminal

<DC>

With surge voltage suppressor (YS, YOS)

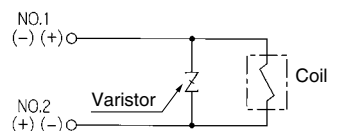

Light/surge voltage suppressor (YZ)

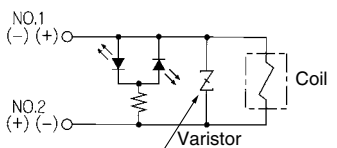

<AC>

With light (YZ)

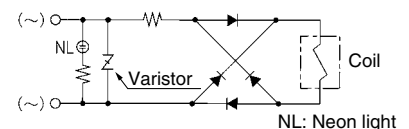

Note) Surge voltage suppressor of varistor has residual voltage corresponding to the protective element and rated voltage; therefore, protect the controller side from the surge.



# Series VQZ Specific Product Precautions 2

Be sure to read before handling.

Refer to front matters 58 and 59 for Safety Instructions and pages 3 to 7 for 3/4/5 Port Solenoid Valve Precautions.

## Light/Surge Voltage Suppressor

### ⚠ Caution

#### 1. Surge voltage countermeasures

When shutting off the DC power supply using an emergency circuit breaker, the valve may operate incorrectly due to surge voltage generated by other electric parts (e.g., the solenoid). To ensure that surge does not affect the valve, take anti-surge measures (diode for surge protection, etc.) or use a valve with diode to prevent reverse current. (Contact SMC for model numbers.)

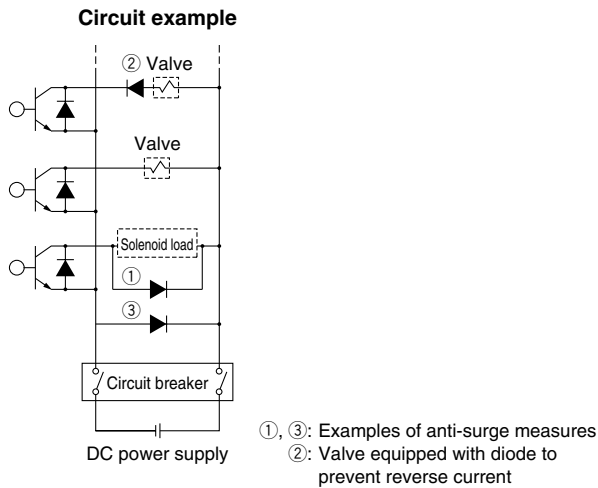

## Lead Wire Connection

### ⚠ Caution

#### 1. Crimping of lead wires and sockets

Not necessary if ordering the lead wire pre-connected model. Strip 3.2 to 3.7 mm at the end of the lead wires, insert the ends of the core wires evenly into the sockets, and then crimp with a crimping tool. When this is done, take care that the coverings of the lead wires do not enter the core wire crimping area.

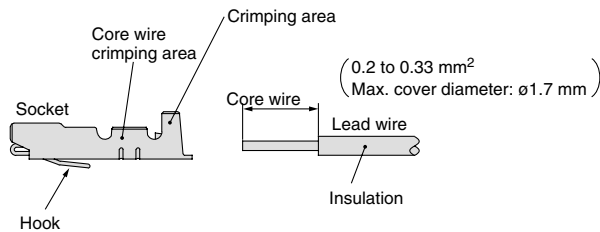

Crimping tool part no. DXT170-75-1

## Lead Wire Connection

### ⚠ Caution

#### 2. Attaching and detaching sockets with lead wires

##### Attaching

Insert the sockets into the square holes of the connector ( $\oplus$ ,  $\ominus$  indication), and continue to push the sockets all the way in until they lock by hooking into the seats in the connector. (When they are pushed in, their hooks open and they are locked automatically.) Then, confirm that they are locked by pulling lightly on the lead wires.

##### Detaching

To detach a socket from a connector, pull out the lead wire while pressing the socket's hook with a stick having a thin tip (approx. 1 mm). If the socket will be used again, first spread the hook outward.

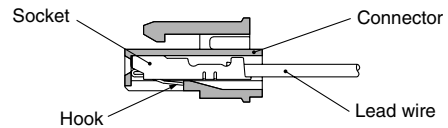

## Pilot Valve Replacement

### ⚠ Caution

#### 1. When replacing a conventional type valve with a new type for maintenance or other reasons, a "conversion connector assembly" is necessary to convert the connector from 3 terminals to 2 terminals and must be ordered separately. (When ordering, refer to the below part nos.)

For pilot valves, there is no compatibility between the conventional type and new type. When replacing a pilot valve, be sure to confirm whether it is the new type or the conventional type.

##### [Conventional]

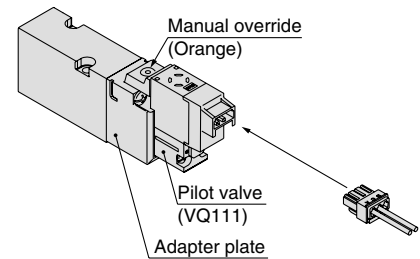

##### [New]

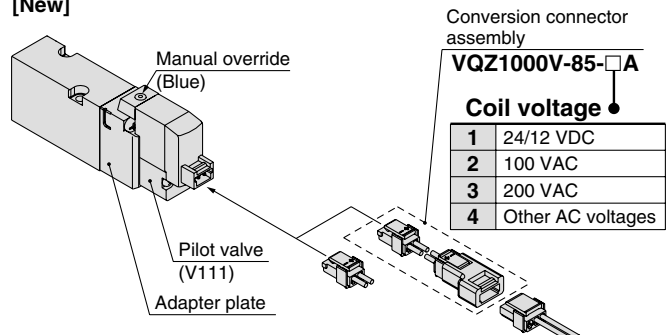

SYJ

VQZ

VP

VG

VP3□



# Series VQZ Specific Product Precautions 3

Be sure to read before handling.

Refer to front matters 58 and 59 for Safety Instructions and pages 3 to 7 for 3/4/5 Port Solenoid Valve Precautions.

## How to Use DIN Terminal

### 1. EN-175301-803C (Former DIN 43650C) (8 mm between pins)

The DIN terminal type with an IP65 enclosure is protected against dust and water, however, it must not be used in water.

### 2. Connection

- Loosen the holding screw and pull the connector out of the solenoid valve terminal block.
- After removing the holding screw, insert a flat head screwdriver, etc. into the notch on the bottom of the terminal block and pry it open, separating the terminal block and the housing.
- Loosen the terminal screws (slotted screws) on the terminal block, insert the cores of the lead wires into the terminals according to the connection method, and fasten them securely with the terminal screws.
- Secure the cord by fastening the ground nut.

### 3. Changing the entry direction

After separating the terminal block and housing, the cord entry can be changed by attaching the housing in the desired direction (4 directions at 90° intervals).

\* When equipped with a light, be careful not to damage the light with the cord's lead wires.

### 4. Precautions

Plug in and pull out the connector vertically without tilting to one side.

### 5. Compatible cable

Cable O.D.:  $\varnothing 3.5$  to  $\varnothing 7$   
(Reference)  $0.5 \text{ mm}^2$ , 2-core or 3-core, equivalent to JIS C 3306

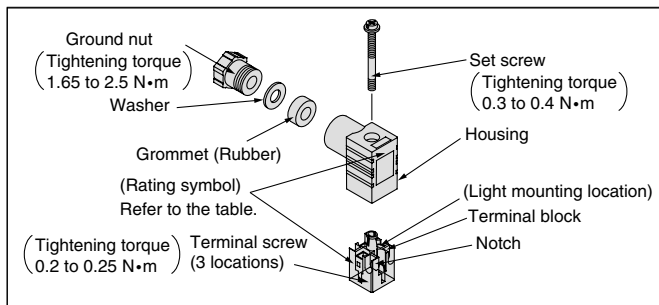

## DIN Connector Part No.

### Without light

Rated voltage	Voltage symbol	Part no.
All voltages	None	SY100-82-1

### With light

Rated voltage	Voltage symbol	Part no.
24 VDC	24 V	SY100-82-3-05
12 VDC	12 V	SY100-82-3-06
100 VAC	100 V	SY100-82-2-01
200 VAC	200 V	SY100-82-2-02
110 VAC (115 VAC)	110 V	SY100-82-2-03
220 VAC (230 VAC)	220 V	SY100-82-2-04

### Circuit diagram with light

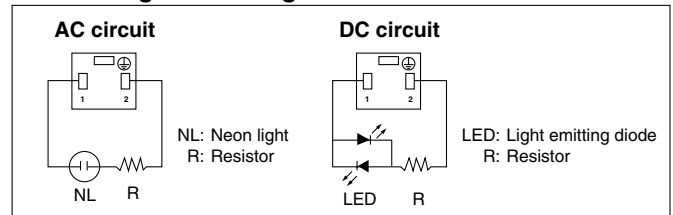

## Fitting and Silencer Part No. for P, R Ports When Using Valve as an Individual Unit

Part no. for one-touch fitting for 1(P) port and silencer/one-touch fitting for 3(R) port

Series	(1) One-touch fitting for 1(P) port	(2) For 3(R) port	
		Silencer	One-touch fitting
VQZ100	KQ2H06-M5	AN120-M5	KJS04-M5
VQZ200	KQ2S06-01S	INA-25-46	IN-457-32 (for $\varnothing 6$ )
VQZ300	KQ2H08-02S	AN101-01	KQ2H06-01S

The diameter of the above fitting and silencer is the maximum diameter to in the EXH port.

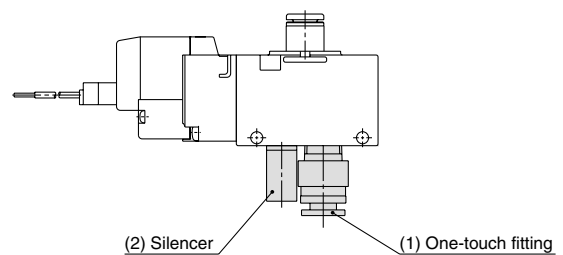





# Series VQZ Specific Product Precautions 4

Be sure to read before handling.

Refer to front matters 58 and 59 for Safety Instructions and pages 3 to 7 for 3/4/5 Port Solenoid Valve Precautions.

## One-touch Fittings Replacement

### ⚠ Caution

The built-in fittings on the manifold can be changed easily. Simply remove the corresponding valve and take out the fitting clip underneath.

Take out the clip with a screwdriver, etc., then replace the fittings. About mounting the fittings, after inserting the fitting until it stops, then put the clip into the prescribed position.

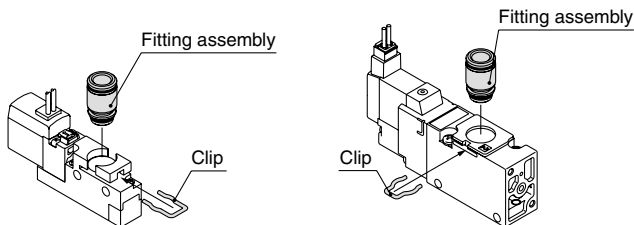

VQZ200: Horizontally clipped to the valve body  
VQZ100/300: Vertically clipped to the valve body

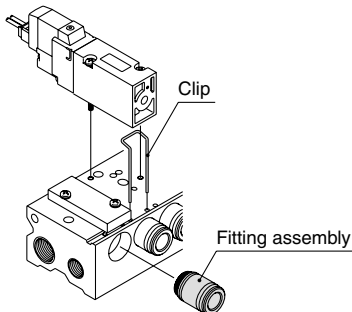

### Precautions

When pulling the fitting assembly away from the valve base, remove the clip, then connect a tube or plug (KQ2P-□□) with the one-touch fitting and pull it out holding the tube or plug. Do not hold the release bushing to avoid damage.

## DIN Rail Removal/Mounting

### ⚠ Caution

#### 1. Removing

- Loosen the clamp screw on the (a) side of both ends of the manifold.
- Lift the (a) side of the manifold off the DIN rail and slide it in the direction of the (b) side.

#### 2. Mounting

- Catch the hook of the DIN rail bracket on the (b) side on the DIN rail.
- Push side (a) onto the DIN rail and tighten the clamp screw. The proper tightening torque for screws is 0.3 to 0.4 N·m.

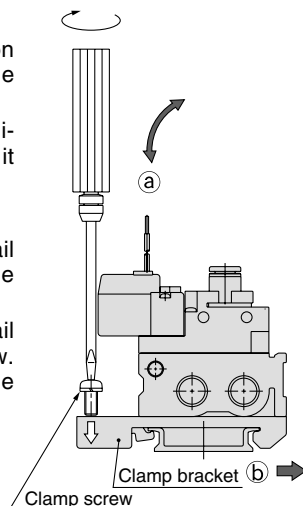

## Valve Mounting

### ⚠ Caution

1. After confirming the gasket is correctly placed under the valve, securely tighten the bolts with the proper torque shown in the table below.

Model	Proper tightening torque
VQZ100	0.13 to 0.19 N·m
VQZ200	0.25 to 0.35 N·m
VQZ300	0.5 to 0.7 N·m

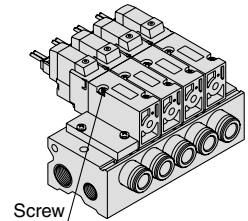

## VQZ100 Piping Direction Replacement

### ⚠ Caution

#### 1. How to replace the port direction

Fitting and port plug are modules. After removing the clip with a flat head screwdriver, take out the fitting and port plug. The piping direction (side or top) can be altered by exchanging the fitting and port plug. During exchange, insert the fitting and the port plug until they contact the wall, then, insert the clip to specified position.

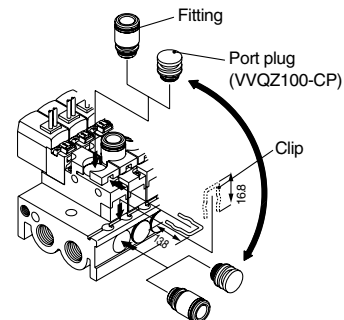

### Precautions

The clip length for the valve and the base are different. Fitting may detach if the incorrect clip is used.

#### 2. Valve piped on top can be operated independently by using PR plate.

(Refer to the below part numbers when placing an order.)

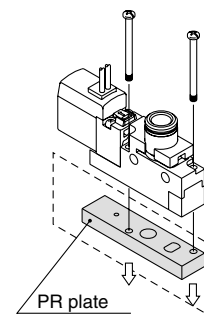

VQZ100-12A (Standard)  
VQZ100-12B (External pilot type)  
\* 2 set screws are included.

SYJ

VQZ

VP

VG

VP□