

Top 100
Global
Innovator
for 10 years

XGT Panel

Human Machine Interface

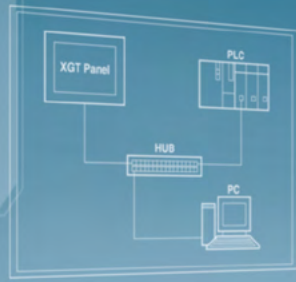

XGT Panel Series is a brand new HMI product with an intensive and advanced technology of LSIS to cope with the rapidly changing market situation. It is an innovative product having both reliability and convenience based on the Windows CE. With the user-oriented convenience, it offers high resolution display, prompt data transmission and processing, and an user-friendly interface. LSIS provides the Leading Solution to the automation field with the XGT Panel Series. We are confident of our XGT Panel Series which contains high technology and our commitment to quality at the HMI market.

With the user-oriented convenience, it offers high resolution display, prompt data transmission and processing, and an user-friendly interface.

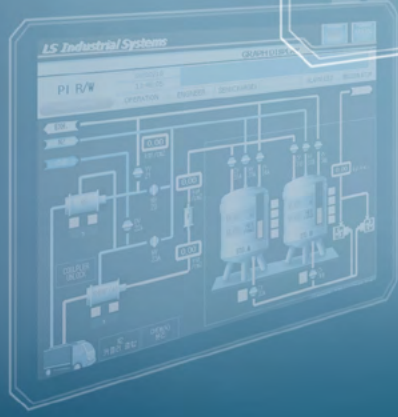

XGT Panel Series is a brand new HMI product with an intensive and advanced technology of LSIS to cope with the rapidly changing market situation. It is an innovative product having both reliability and convenience based on the Windows CE. With the user-oriented convenience, it offers high resolution display, prompt data transmission and processing, and an user-friendly interface. LSIS provides the Leading Solution to the automation field with the XGT Panel Series. We are confident of our XGT Panel Series which contains high technology and our commitment to quality at the HMI market.

**Leading Innovation,
Creating Tomorrow**



LS ELECTRIC creates the core automation solutions for the fields ranging from production facilities to information systems.

It is the device and software operable using a designed screen for users to monitor and control the operating status of given facilities and equipments.

Windows CE platform based XGT panel is a user-friendly solution, providing convenient, clear and realistic display, prompt data transmission and processing as well as easy environments.

Based on the advanced technologies, LS ELECTRIC satisfies various requirements of clients, from unit facilities to advanced industrial fields, leading the HMI market.



C O N T E N T S

XGT Panel iXP2 Series	04
XGT Panel iXP Series	06
XGT Panel eXP2 Series	08
XGT Panel eXP Series	10
Products Line Up	12
Feature	
Hardware Related Functions	14
XP-Builder	22
Software Related Functions	24
Advanced Functions	26
Link with Controllers	28
External Monitoring Function	31
System Block Diagram	32
Our Solution	34
Products	
iXP2 Series	36
iXP Series	38
eXP2 Series	40
eXP Series	42
List of Communication Drivers	44



NEW
Product

XGT Panel

iXP2 Series

intelligent XGT Panel



High functioning, user friendly and robust choice for your system, iXP2



Durability

- Slim and durable design with aluminum frame and a reinforced glass
- IP66 Certification with enhanced waterproofing and protection against dust.



Flexibility

- Dual Monitor function clone/extended mode
- Multi-touch setting to prevent malfunction



Connectivity

- Various external interfaces to provide IoT solutions
- Ethernet 2ch., HDMI/Audio output, USB host/device, multimedia (video)



Convenience

- Same as iXP panel cut that can be replaced
- Depending on touch sensitivity, you can set it up with bare hands or gloves.



Responsive touch screen

- Touch sensitivity is improved by applying responsive touch screen.
- Use touch screen either with bare hands or with gloves.
- Various types of touch setting function can be used according to user's work environment



Dual-Core CPU offers high-speed communication and processing

High luminance/resolution LCD with an LED backlight and 24 bit colors to express clear and vivid colors of 16,777,216.

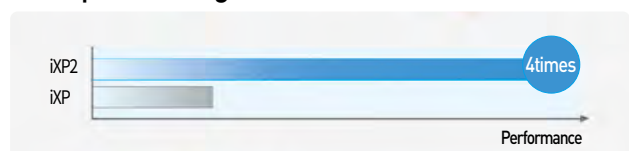



XGT Panel

iXP Series

intelligent XGT Panel

Convenient control with a single touch!

A user-oriented interface, enhanced performance, and soft and quick screen switching and respond speed to touch!

Meet iXP series of LS ELECTRIC that genuinely and fully connects humans with equipments.



It is highly competitive using the user-friendly technologies.

- ☑ Quick screen switching and response speed to touch
- ☑ 16.7M TFT colored LCD
- ☑ Large drawing / backup memory (Drawing-128MB, Backup-1MB)
- ☑ Sound Output support
- ☑ Various interfaces
 - USB Host 3ch (Front: 1, Rear: 2), Device 1ch (Front)
 - SD card
 - Various communication drivers provided
- ☑ Presence sensor applied (within 1m)

High Speed

High-performance 1GHz CPU is installed to improve the data and screen switching speed, and Windows CE 6.0 OS is adopted to execute NET-based external applications.

Large Memory

Large device memory is provided to save mass data.

Storage space for screen and images

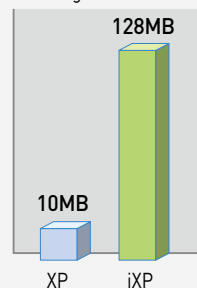

Data backup space for alarm and logging

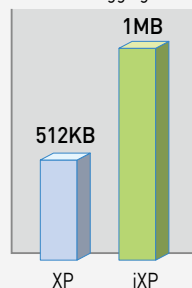

Presence Sensor

Sensor detects movement within 1m, to control the backlight, ensuring a longer life of the product.

More Colorful

High luminance/resolution LCD with an LED backlight and 24 bit colors to express clear and vivid colors of 16,777,216.

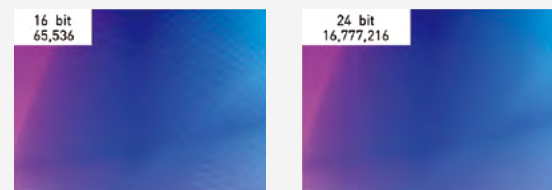

Customize

- Put your company's brand on the front of HMI (inquire of your sales person about minimum order quantity condition).
- Purchase only hardware of HMI minus monitoring software if you do not need it (.NET Framework 3.5 included).



Fully Compatible With eXP

- Externally, the panel-cut, interfaces, and design are maintained.
- Drawing file is 100% compatible

Superior Performance

- ARM Cortex A8 800MHz platform, eMMC 4G, DDR3 / Windows Embedded Compact 7.0 applied
- Improved project downloading speed by 2X, screen switching speed by 4X, booting time by 1.2X, and graphic rendering by 2X compared to eXP.

Performance Comparisons (eXP → eXP2)

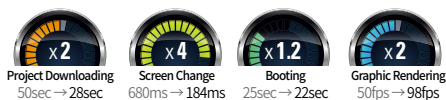

※ May vary depending on operating conditions

Enhanced Product Reliability

- LCD Backlight Lifespan(7": 20,000 Hrs → 50,000 Hrs, 10.1": 20,000 Hrs → 30,000 Hrs)
- Non Battery Type NVRAM (Logging, alarm, and protection of internally retained device data)

Variety of Interfaces and Functions

- Consistent update of communication drivers. 105 communication drivers (54 companies including LS ELECTRIC) are available currently.
- Various functions including Portrait Mode, PDF Viewer, FTP Client, and VNC Viewer are available.



NEW
Product

XGT Panel

eXP Series

efficient XGT Panel



Effective Control and Monitoring Solution Cost-Efficient eXP!

- Simple Design
- 4.3", 7" and 10.2" wide-screen sizes TFT color LCD
- Wide variety of communication interfaces
 - 2-3-channel serial communication
 - Ethernet
- Large memory for drawing (64MB)
- RTC function (maintained by battery)
- Convenient downloading/uploading of drawings via USB port in the front



Higher Level of Performance

Gives superior performance with improved CPU compared with the existing products

Wider Variety of Communication Interfaces

Communicable simultaneously with PLC, barcode reader, VFD, temperature controller

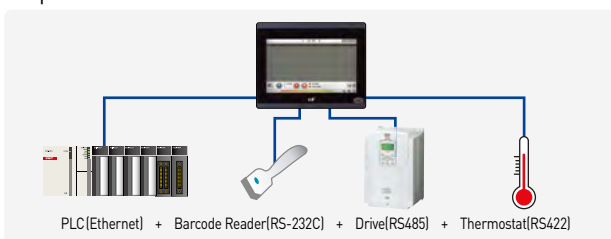

Slimmer and Lighter in Weight

20% lighter than previous products, provides more space and lightens user's panels



Customize

Put your company's brand on the front of HMI (inquire of your sales person about minimum order quantity condition).



Products Line-up

XGT Panel

Window CE-based new HMI developed with advanced technologies of LS ELECTRIC to optimize the user experience

		15" (38Cm)	12.1" (31Cm)	10.4" (26Cm)
iXP2 Series	Premium Ethernet I/F USB I/F Serial I/F (RS-232C) Serial I/F (RS422/485) SD Card I/F HDMI I/F	iXP2-1500 TFT 16,777,216 Colors XGA(1024×768)	iXP2-1200 TFT 16,777,216 Colors XGA(1024×768)	iXP2-1000 TFT 16,777,216 Colors XGA(1024×768)
	Premium Ethernet I/F USB I/F Serial I/F (RS-232C) Serial I/F (RS422/485) SD Card I/F	iXP90-TTA *2 TFT 16,777,216 Colors XGA(1024×768)	iXP80-TTA *2 TFT 16,777,216 Colors SVGA(800×600)	iXP70-TTA *2 TFT 16,777,216 Colors SVGA(800×600)
eXP2 Series	Standard Serial I/F (RS-232C) USB I/F Serial I/F (RS422/485) Serial I/F (RS-485) Ethernet I/F Micro SD Card I/F			10.2" (25.9Cm) eXP2-100□ *4 TFT 16.7M Colors WSVGA(1024 X 600)
	Standard Serial I/F (RS-232C) USB I/F Serial I/F (RS422/485) Serial I/F (RS-485) Ethernet I/F			10.2" (25.9Cm) eXP60-TTA *3 TFT 65,536 Colors WVGA(800×480)

8.4"(21Cm)

iXP2-0800



TFT 16,777,216 Colors
SVGA(800×600)

8.4"(21Cm)

iXP50-TTA *2



TFT 16,777,216 Colors
SVGA(800×600)



7"(17.7Cm)

5.6"(14.2Cm)

4.3"(10.9Cm)

eXP2-070 □ *4

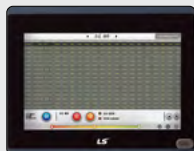

TFT 16.7M Colors
WVGA(800×480)

eXP2-050 □ *4



TFT 262,144 Colors
VGA(680×480)

eXP2-040 □ *4



TFT 16.7M Colors
VGA(480×272)

7"(17.7Cm)

5.6"(14.2Cm)

4.3"(10.9Cm)

eXP40-TTA *3
eXP40-TTE *1 *3



TFT 65,536 Colors
WVGA(800×480)

eXP30-TTA *3
eXP30-TTE *1 *3



TFT 65,536 Colors
VGA(680×480)

eXP20-TTA *3



TFT 16.7M Colors
VGA(480×272)

*1 : Ethernet I/F not supported. *2: CF card I/F not supported. *3: SD card not supported. *4: 0(Ethernet O), 1(SD I/F, Ethernet O), 2(Ethernet X)



Feature

High functioning, user friendly and robust choice for your system, **iXP2**

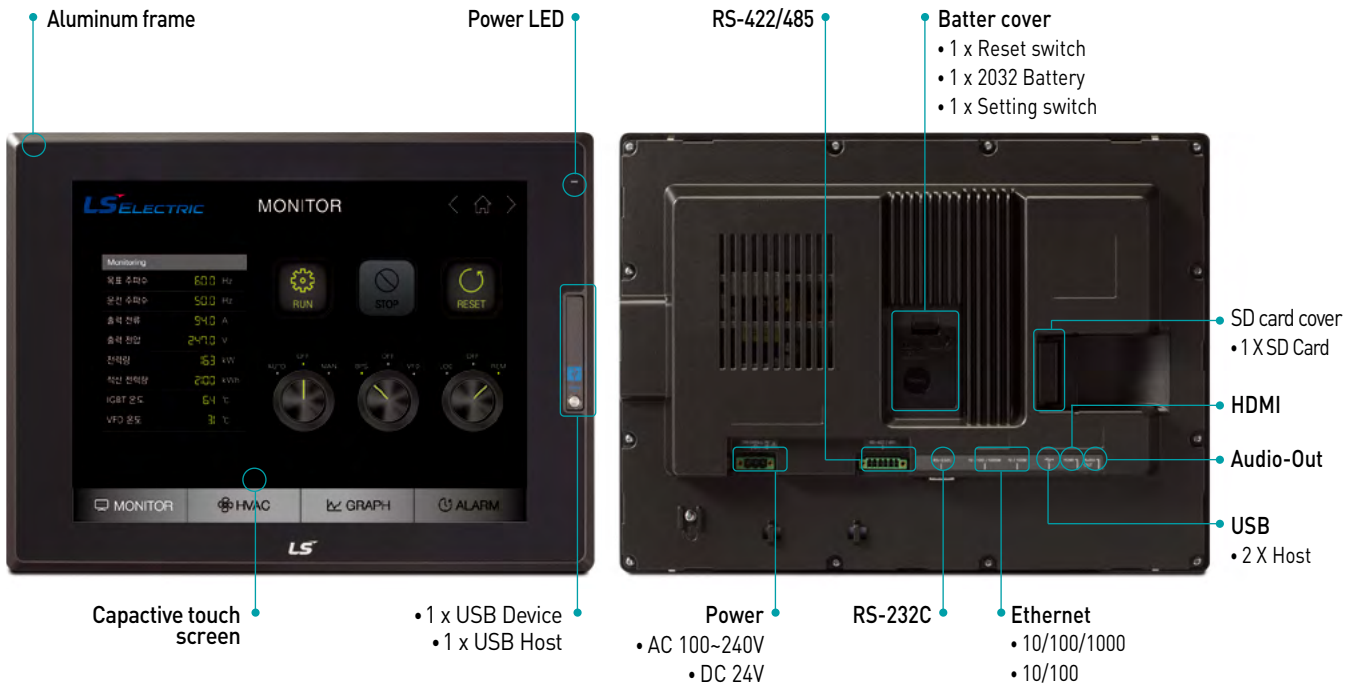

iXP2 Multiple interface methods to cope with the Internet of Things

Ethernet 2ch., HDMI / Audio output, USB host/device, multimedia (video)



iXP2 Multi-touch and gesture-control screens

Multi-touch maximizes operating stability and safety. Use gesture-control to view logging trend graphs and to change screens.



iXP2 Robust IP66 aluminum frame

Reinforced protection against water and dust. Conforms to NEMA 4X standard.



iXP2 One to one interchangeability with existing iXP series

Offers equivalent panel cut to iXP.

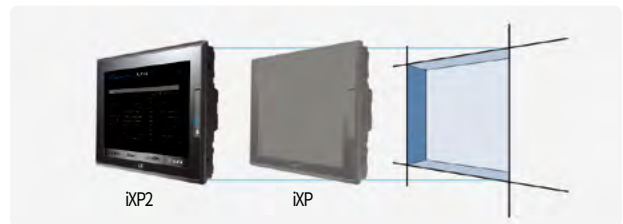

iXP2 Screen gesture

Flick to change screens.
No extra switching button is needed to change screens.



iXP2 Object gesture

Select the object you want and then swipe and flick it.
Object list

- Logging trend graph
- View logging history
- View history alarms



iXP2 Multi-touch

Use multi-touch to protect your system from undesired errors.



iXP2 Dual monitor mode and extension mode

Increase your convenience by duplicating or extending your screens.

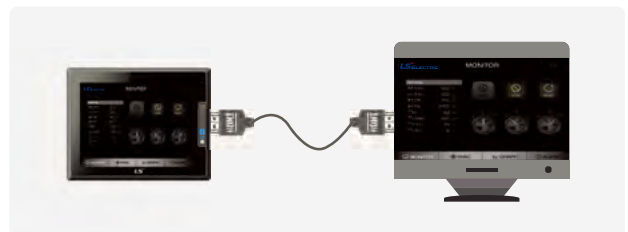

Hardware Related Functions **iXP**

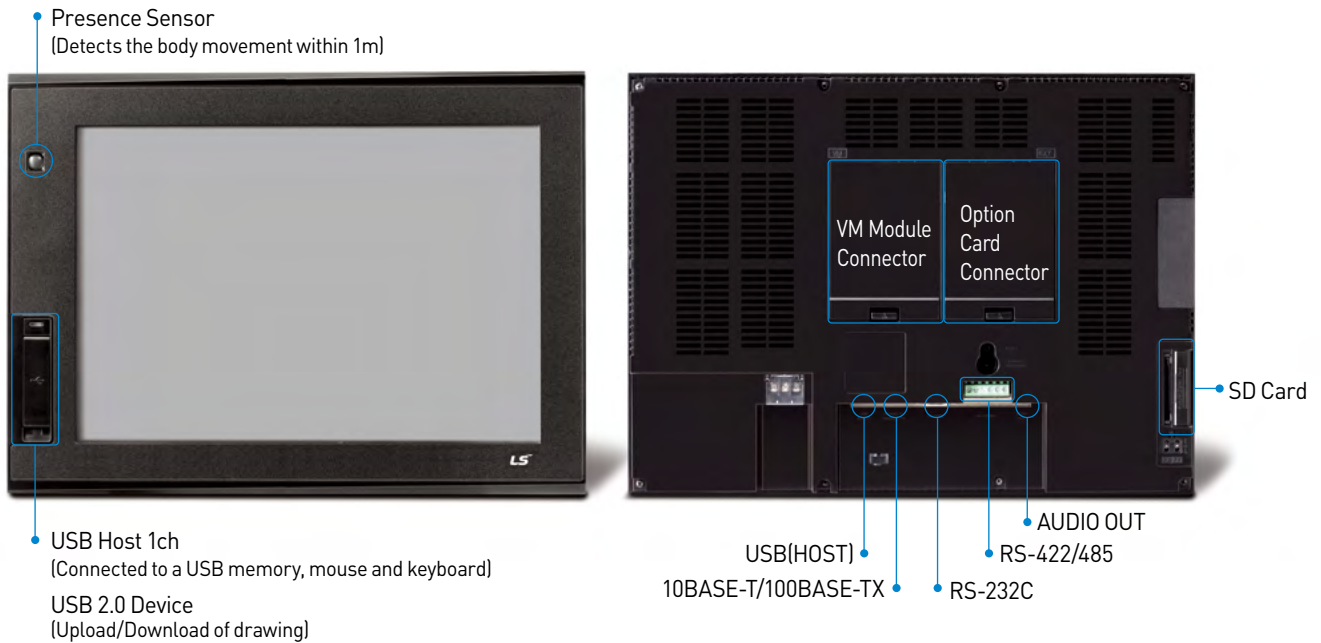

iXP 1 Respective Front USB Host/Device Channel

- An additional USB host channel is installed in the front panel.
- A front USB host is used to connect to a USB memory, mouse and keyboard.
- A front USB device port is used to change the XP-Runtime without opening a control panel or download/upload the drawing file created using XP-Builder.
- USB cable: USB-301A 2.0



iXP Sound Output Function (For all iXP models)

- The sound files (wav, mp3) registered using XP-Builder can be output to speakers connected to HMI.
- An alarm is generated via speakers to warn operators.
- Up to 512 sound files can be saved.



iXP Function to use SD Cards

iXP supports additional SD memory cards along with previous USB memory to diversify the backup means.



iXP Presence Sensor

- The XP presence sensor detects movement within 1m to turn on a backlight.
- When not used, it turns OFF the screen to maintain a longer lifespan of the backlight.

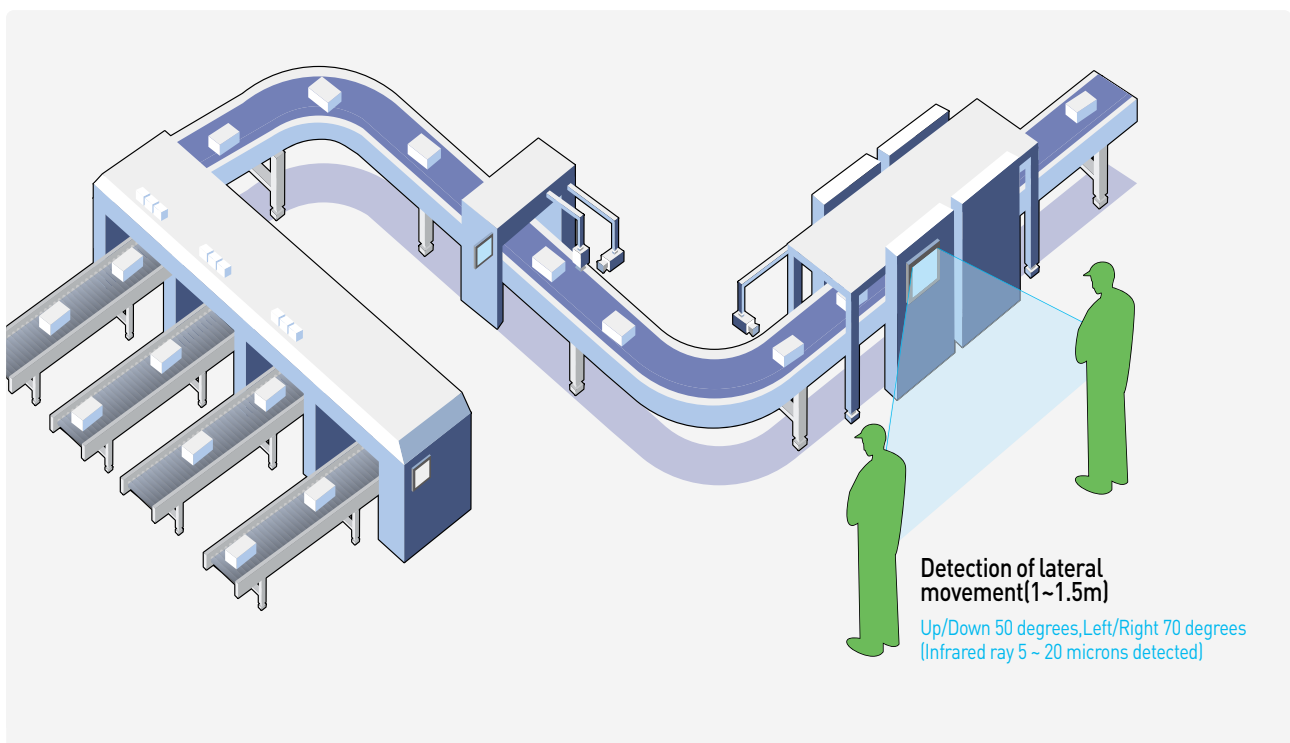
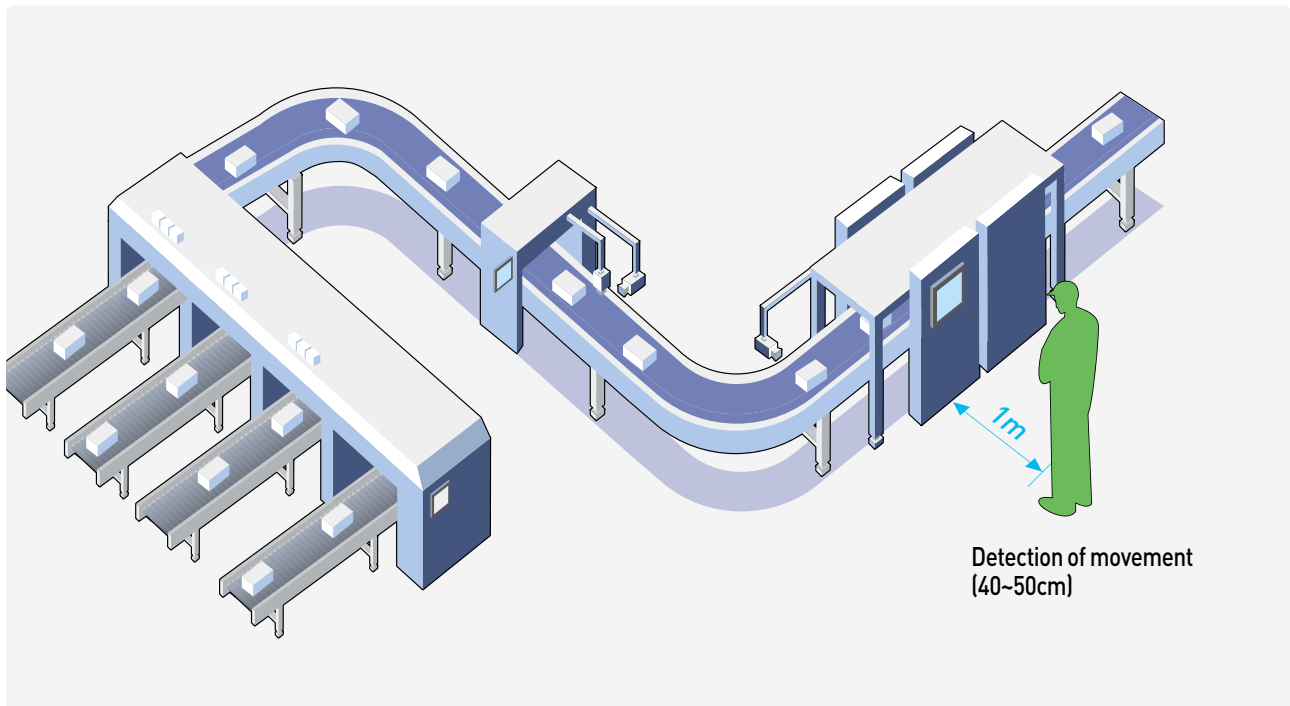



Feature

New Features in eXP2 **eXP2**



USB Device

- Logging/Recipe/Screen data backup
- Download/Upload project
- Upload project file
- XGT Panel update

USB Host

- USB memory connection: logging/recipe/screen data backup
- Project data transfer/backup
- User interface connection: mouse/keyboard
- Printer connection

RS-232C/485 Connector

Ethernet Terminal

Power Terminal

- Power input (24VDC)

RS-422/485 Connector

Micro SD Card

eXP2 Portrait Mode



- Vertical mounting is available
- Setting in XP-Builder: [COMMON]-[Project Property Setting]

Item	eXP	eXP2
Vertical Mode	eXP20 Only	0
PDF Viewer	X	0
FTP Client	X	0
VNC Client	X	0

eXP2 PDF Viewer



- PDF files can be displayed on XGT Panel.
- In the event of an alarm, the content of the alarm's trouble shooting can be checked on site as a PDF file.
- PDF files on an FTP server can be displayed using a PDF viewer object.

eXP2 FTP Client

- FTP client is an object that can connect to the FTP server, display the list of files and directories on the FTP server, and download the selected file.
- PDF files on an FTP server can be displayed using a PDF viewer object.

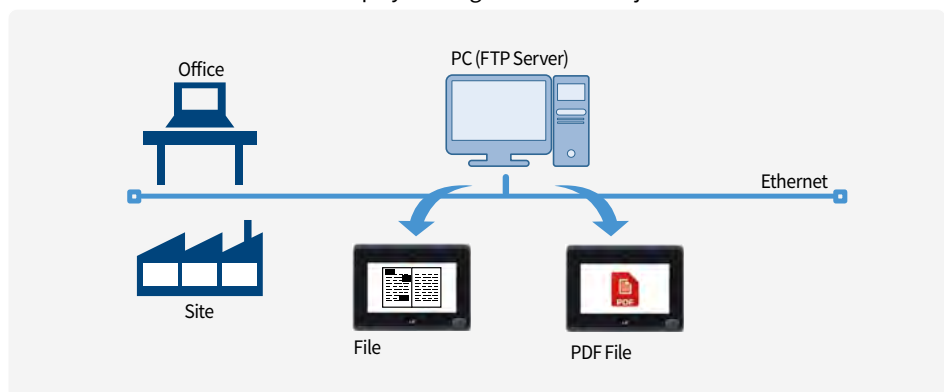

eXP2 VNC Viewer

- Remotely monitoring PC or HMI using VNC Viewer is available
 - Download VNC server to HMI using XP-Manager.
 - Install a universal VNC server on your PC. (Ultra VNC, Real VNC, etc.)
- Add 'VNC Viewer' object to the project screen.

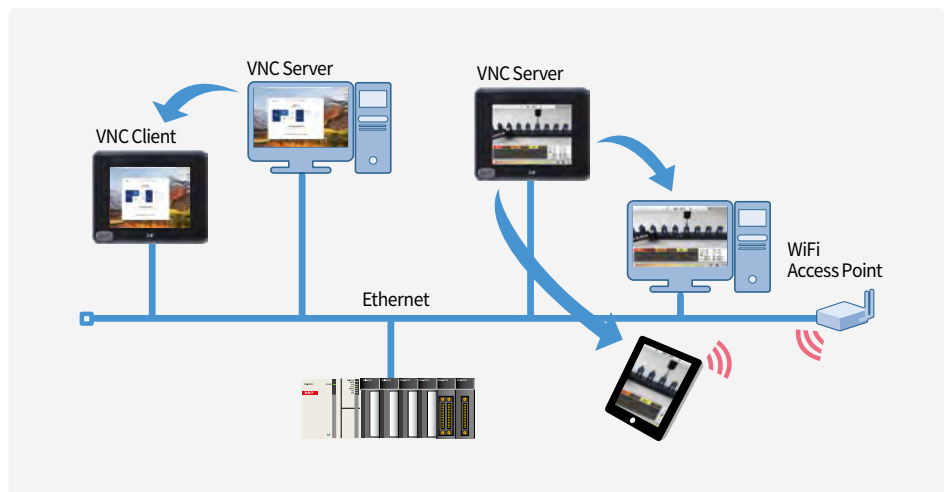

Hardware Related Functions **eXP**

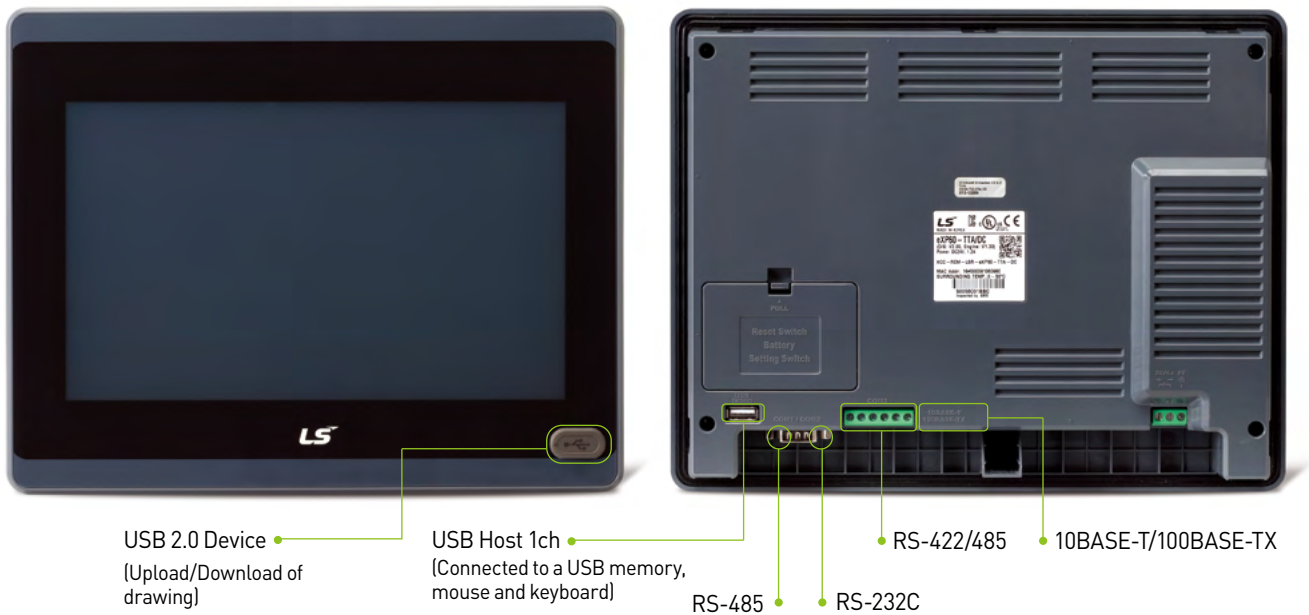

eXP USB Port in the Front for Devices

- With USB port in the front, no need to open the control panel to apply changes to XP-Runtime or download/upload drawing files made in XP-Builder
- USB cable: USB-301A 2.0



eXP RTC Function

- RTC (Real Time Clock) function operates with a battery even with the power off
- HMI time setting is adjustable quickly using XP-Builder

eXP High Performance

- About 30% better performance

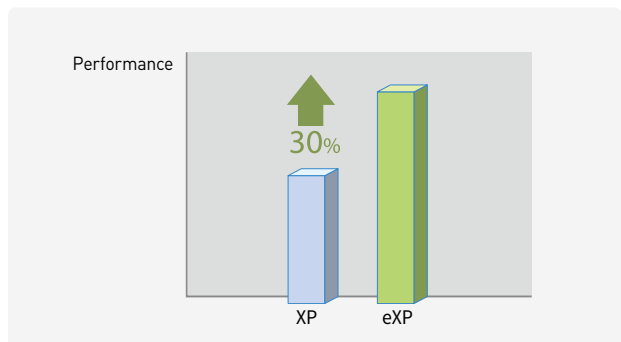

eXP 3-Channel Serial Communication

- Simultaneously communicable by RS-485, RS-232C, RS-422/485
- D-Sub 9-pin terminal includes COM1 and COM2

Hardware Related Functions **iXP2** **iXP** **eXP2** **eXP**

Ethernet method for Quick Transmission of Mass Data

- Ethernet method has improved the transmission speed. Compared to the conventional RS-232C method, a quicker transmission speed: 115kbps → 10/100Mbps
- Regardless of the memory capacity, the drawing files can be quickly uploaded/ downloaded, and logging/alarm/recipe data can be conveniently used.
- Ethernet method is used for various production data collection, monitoring and control using PC.

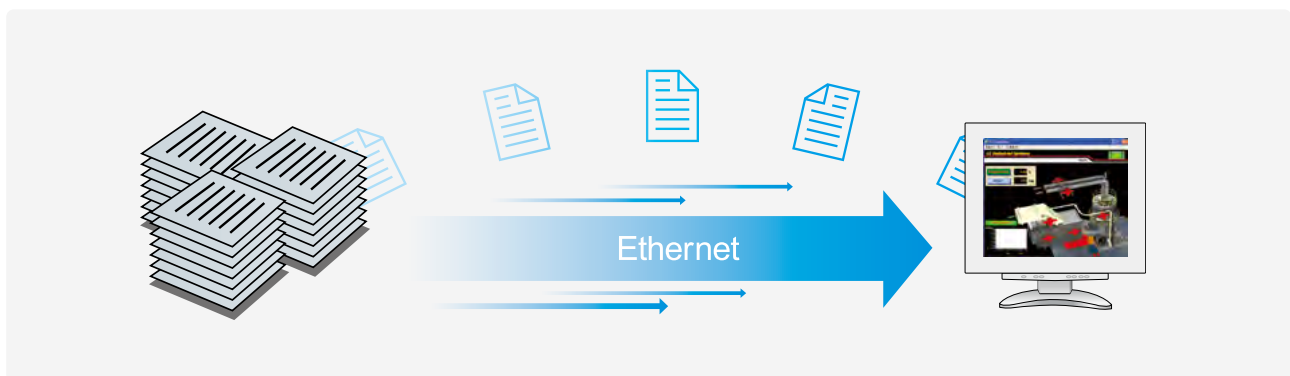

Barcode Scanner Communication

- ASCII data imported by accessing a barcode scanner from XGT Panel can be saved in the user-assigned PLC or XGT Panel's internal memory.
- Complete Bit can be randomly saved. It allows users to check whether the XGT Panel has read the data without errors.
- Communication with barcodes is possible by using the RS-232C interface installed in the XGT Panel.

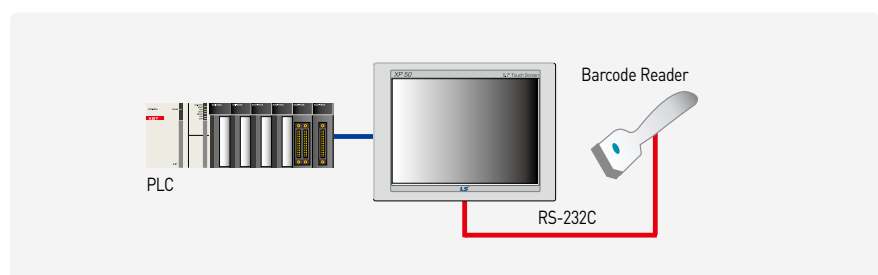

Providing Various Communication Channels

Using RS-232C, RS-422/485 and Ethernet, XP/eXP and iXP2/iXP are capable of communicating with up to 4 and 6 types of controllers, respectively. Refer to the system block diagram (TTE type does not have an Ethernet module).

XP-Builder

XGT Panel offers easy and user-friendly multi-interface.

XP-Builder Functions

Implementation of multiple programs

In order to use the previously created drawing data for a new drawing, more than 2 XP-Builder programs are executed simultaneously.

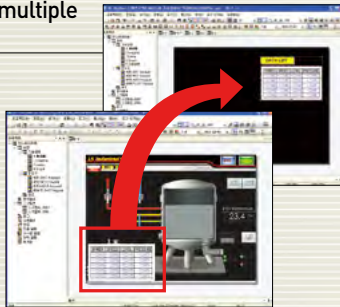

Function to check data

- To check for any error on the data created, and errors can be corrected by clicking on them.
- The specific description of error created is displayed.



Cross-reference function of devices

Devices used for drawing data and tags are displayed.

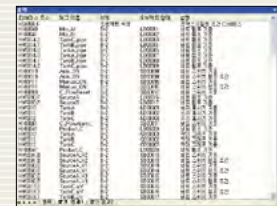

Animation function

- When GIF format is used, animation effects can be realized depending on the state of given bit.
- When a video clip on given site is created into GIF to be added to a drawing screen, more accurate information can be delivered to users. (Video clip files can be created using the commercial software for GIF creation)

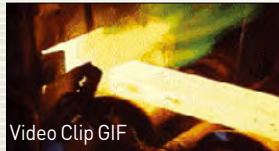

Drawing Editor: XP-Builder

Project Window

Add, delete and edit project property, logging, recipe and alarm conveniently.

Data Element Window

- Displays the objects on a screen currently shown.
- When double-clicked, a window on setting the properties appears.

Screen Window

Add, delete and edit basic screens, window screens and part screens easily

Output Window

- Displays the error checked on drawing data and the search results.
- It displays the specific description of the errors created.

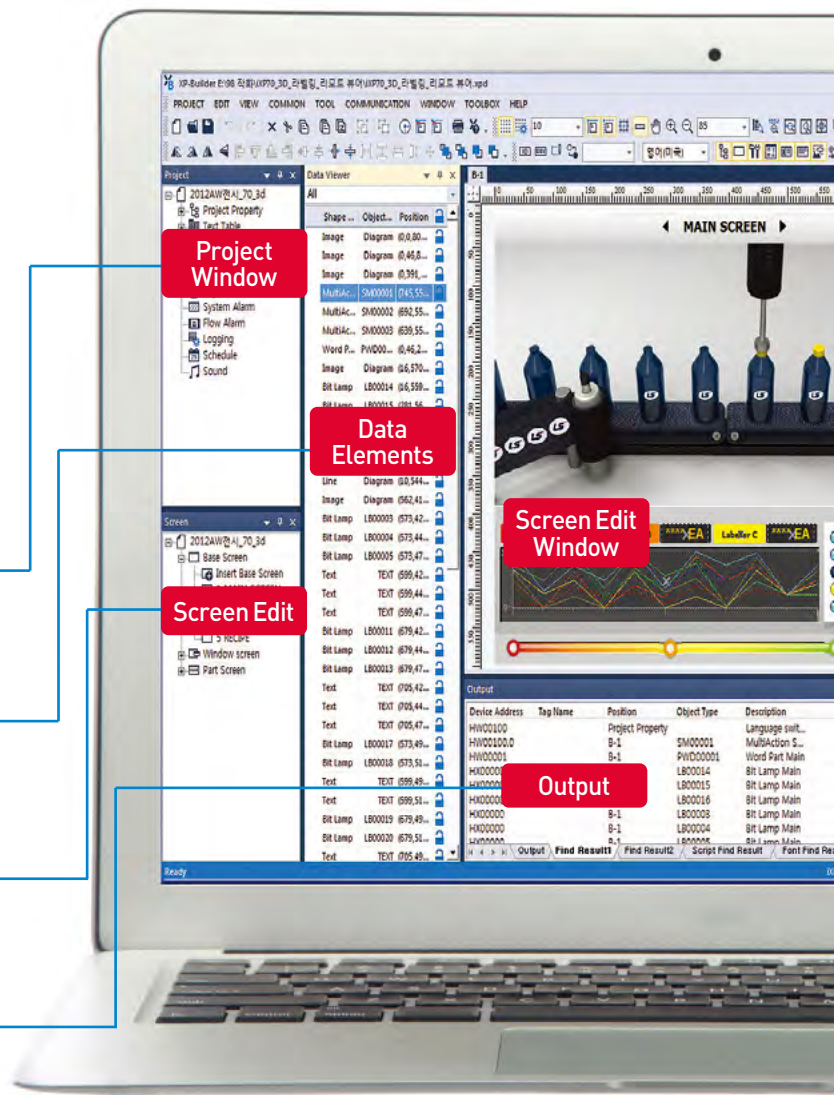

Tag function

- Users can set device address by desired name, which can be used in an object.
- When a set device is tagged to an object, addresses can be changed, collectively.
- Up to 10,000 tags can be registered.

주소	이름	타입	주소	이름
1	SourcA	BIT	1	HM000.F
2	SourcA#	BIT	2	HM000.E
3	SourcA.V1	BIT	3	HM000.E
4	SourcA.V2	BIT	4	HM000.E
5	SourcA.V3	BIT	5	HM000.E
6	SourcA.V4	BIT	6	HM000.E
7	SourcA.V5	BIT	7	HM000.E
8	SourcA.V6	BIT	8	HM000.E
9	SourcA.V7	BIT	9	HM000.E
10	SourcA.V8	BIT	10	HM000.E

Various fonts with convenient setting options

- Windows fonts used in a PC can be transmitted to HMI for use.
- When using Windows fonts, font attributes (Italic, bold and underline) can be used as well.
- Various font sizes including True Type are supported.
- Supports the Unicode, characters of other countries such as the standard font and high-quality fonts are beautifully displayed.
- Sophisticated and elegant text can be used to create a screen using various fonts.

Arial : ABCDEFGHIJKLMNOPQRSTUVWXYZ
 Book : ABCDEFGHIJKLMNOPQRSTUVWXYZ
 Impact : ABCDEFGHIJKLMNOPQRSTUVWXYZ
 Helvetica : ABCDEFGHIJKLMNOPQRSTUVWXYZ
 Tahoma : ABCDEFGHIJKLMNOPQRSTUVWXYZ
 Time : ABCDEFGHIJKLMNOPQRSTUVWXYZ
 Verdana : ABCDEFGHIJKLMNOPQRSTUVWXYZ

가나다라마바사아자차카타파하
 가나다라마바사아자차카타파하
 가나다라마바사아자차카타파하
 가나다라마바사아자차카타파하

User-oriented screen UI

Providing a flexible script language

- Provides a screen UI that can be easily used considering user's experiences.
- Divided into categories so that a graphic library can be easily searched.
- Various graphic libraries are offered for enhanced usability.

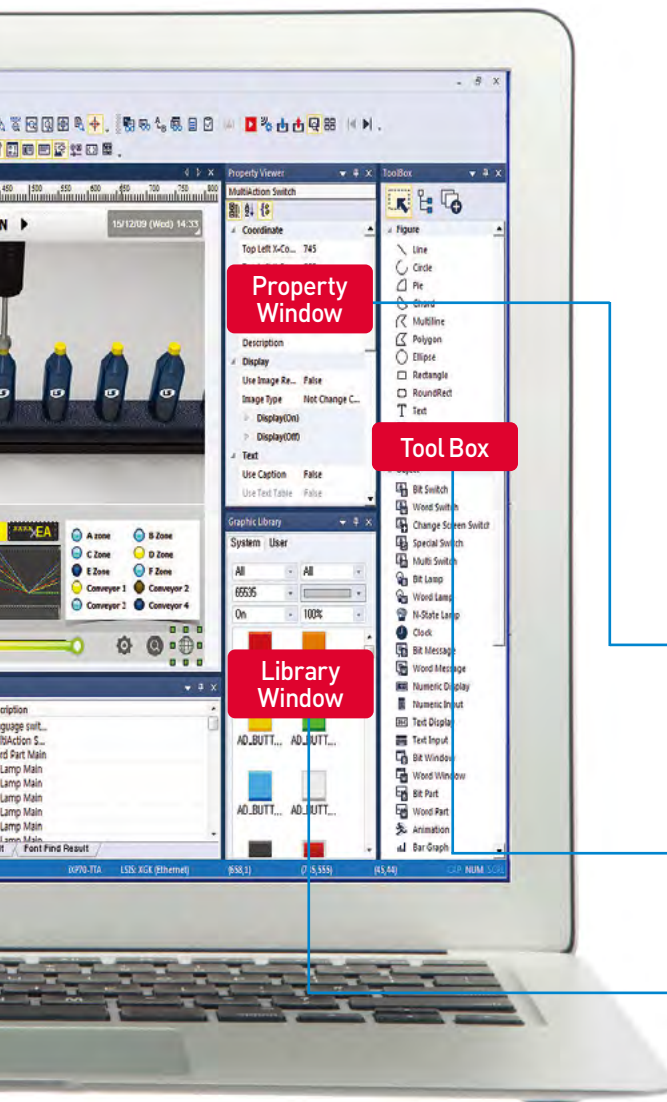

Property Window

This function enables users to change properties of numerous objects at once, so that users do not have to open each object like a button or a lamp for modification.

- Numerous objects on the screen can be selected at once to replace the pictures, enhancing users' convenience.
- When modifying several objects, only the objects with the same function should be selected.
- Users can correct both pictures and properties.

Tool Box

Used to select an object or draw a shape.

Library Window

- Library is divided by category for easier use, and preview is used for drawing.
- Convenient for users to register and delete the Library.
- Drag & Drop is used for a screen insertion.

Software Related Functions

Multi-lingual support & conversion to respond to the global enterprise environments

- In response to enterprise environment of global era, up to 12 languages can be simultaneously converted and users can select a language depending on his/her nationality.
- When desired character string is registered in a table, a language can be converted into a device value and switched upon operation.
- The languages supported include Korean, English, Chinese (PRC/Taiwan), Japanese, French, Turkish, Iranian (Persian), German, Greek, Russian, Italian, Norwegian, Polish, Portuguese and Spanish, all of which are supported in Windows.

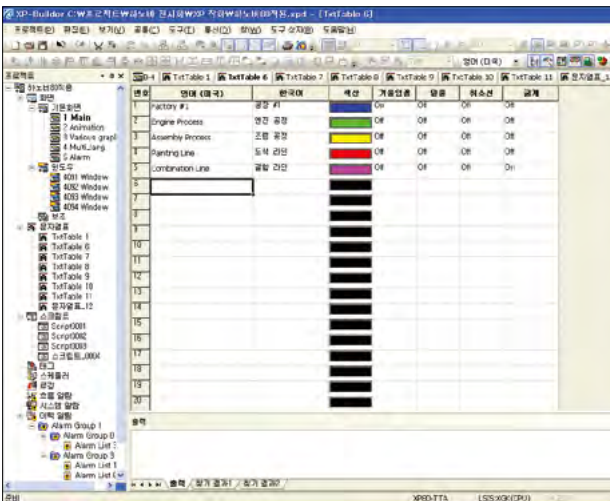

Strict control management using security setting

- Upon PLC control using objects like a switch or an input method editor, only the authorized users can perform controls depending on the set security level.
- It supports 10 security levels in total, and the password of a sub-level can be accessed using the password of a main level.
- When the security level is authorized, a session is disconnected after a certain period of time, asking for the password again.

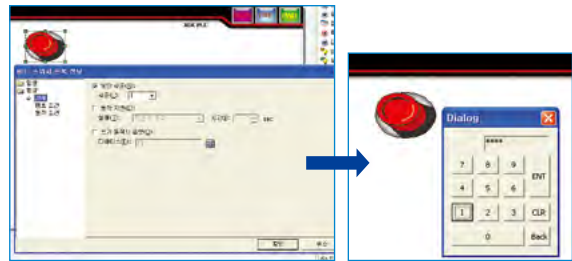

Free and easy moving of parts

- The fixed values and the parts related to the word device are selected/ switched to be displayed on a screen, and the images registered as the given parts can be used.
- A mouse is used to set the movement points for free moves, linear moves, and moves based on the XY coordinates, which can be chosen by users.

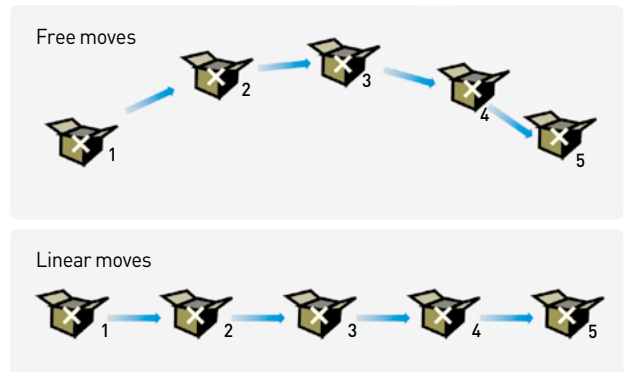

Automatic registration of a character string table

This function enables the character string input by users in the objects to be automatically registered.

- When the file created using a single language is to be changed to a character string table for the purpose of multi-lingual support, it can be automatically registered to the character string table without inconvenience of users.
- All the static strings used in objects can be registered in the character string table.
- Up to 10,001 character strings can be added to a character string table, and the name of a new character string table and the editing languages can be set and registered by users.

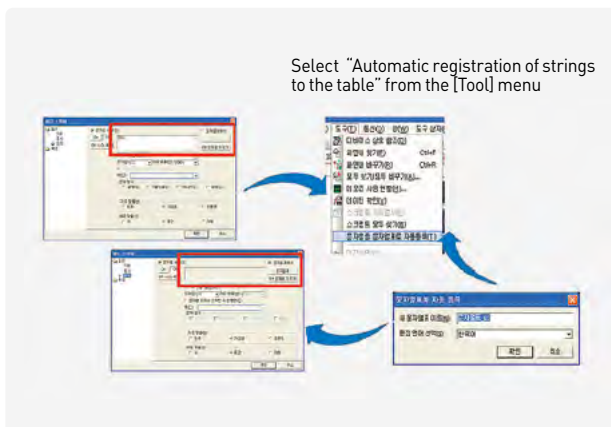

Memo pad function

Function to create or save a short message by selecting various pen thicknesses and colors on XGT Panel.

- It is useful in exchanging messages between operators working in turns.
- The user chooses the thickness and color of the pen and writes on a screen in order to input the message.
- Such memo can be saved in a CF card or a USB memory, and the data are archived even when the power is turned off.
- Users touch the screen and drag to create a memo.
- When creating a memo, users can UNDO/REDO the memo, the thickness/color of a pen can be changed, and a specific memo or all memos can be deleted.

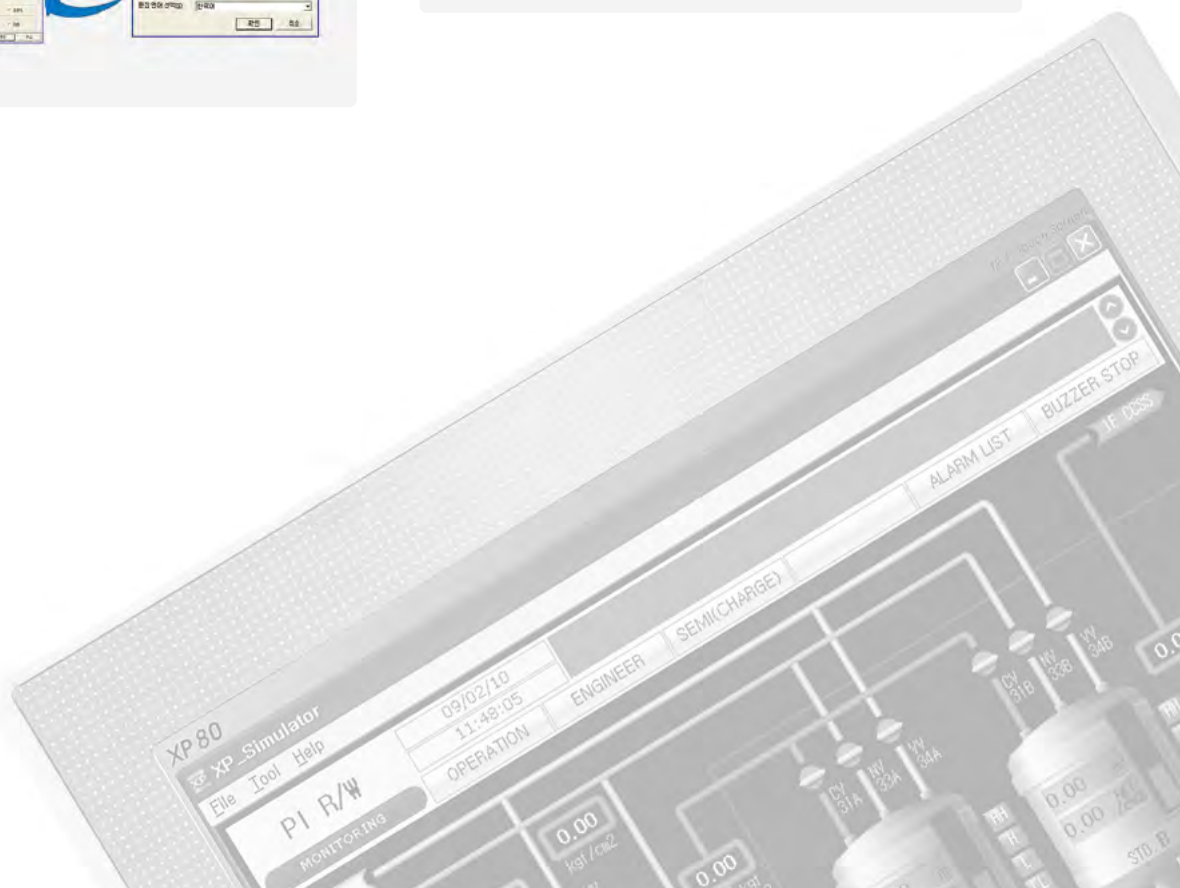
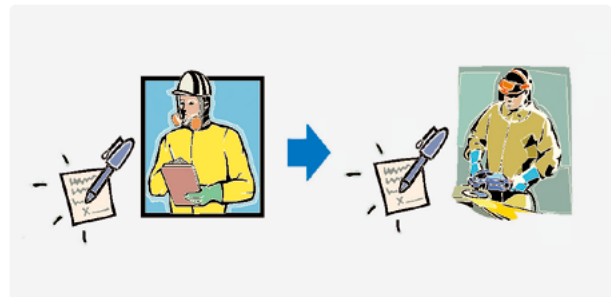

Advanced Functions

Alarm Function

- History Alarm**
 The history of alarms can be saved in the device to check the description of occurrence.
 The alarm can be categorized into up to 8 upper and 8 lower class groups or an alarm list, and an alarm explorer can display only the group alarms the user may desire. When a screen on description to check the details of alarms generated is registered, the detailed screen window linked to the alarm will appear.
 (It can be used to check the measures or detailed description when an alarm is generated.)
- Flow Alarm**
 The alarm generated is displayed on the upper/mid/lower section for users to promptly take actions.
 Flow alarm can be set to be operable at a specific screen, so it can be used to deliver the information on equipments and company.
- System Alarm**
 When a serious fault or a trouble of HMI occurs, the system alarm informs the users, which is a critical function.

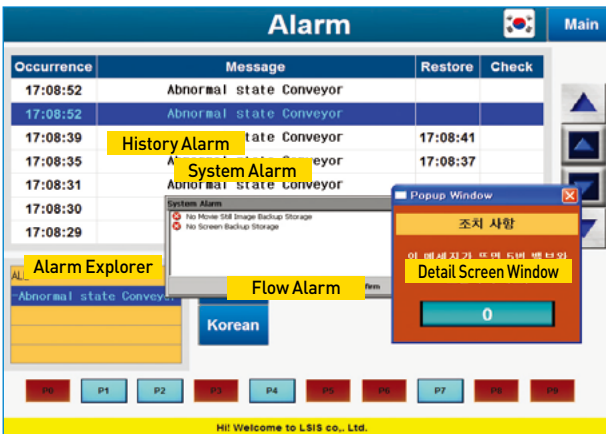

E-mail Function

- It offers a function to send backup files (.csv) using the E-mail address registered upon backup of the logging and alarm data in XGT Panel.
- The E-mail function for logging can only send the backup files of the group desired for each logging group.
- The E-mail function for history alarm includes a function to send to the E-mail only on the alarm messages to the designated receivers when the user-assigned alarm is generated or recovered.
- The logging and alarm backup files sent can be easily analyzed in PC using a program like EXCEL.

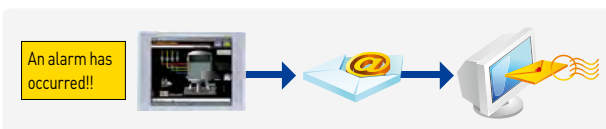

Logging Function

- It offers a cyclic logging that is repeated depending on the time and device state and a conditional logging which works under the device conditions.
- Up to 32 logging areas (conditions) can be provided, and the maximum size of an area can be set up to 512Kbyte, 100DWord.
- Up to 512Kbyte, 100DWord (64Bit upon bit logging) per logging can be saved.
- Basically, logging is saved in the built-in SRAM(512Kbyte, 100DWord), and the backup of logging is available using the CF card, SD card, USB memory stick or USB external hard disk.
- Logging data can be viewed in XGT Panel using a logging view object, and they can be converted into a CSV format to be easily edited using a PC via software such as EXCEL.

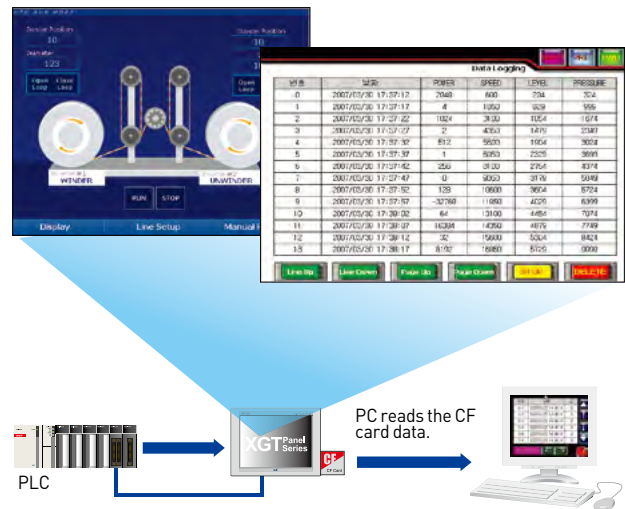

Encryption of Logging/Alarm Backup Files

- The backup file format can be archived as binary files to prevent the data from being damaged or manipulated.
- The encrypted files can be converted into CSV files using a CSV file converter offered from XP-Builder.

Able to View PDF

- Viewing PDF file XGT Panel
- Saving trouble shooting instructions for failures (alarm) in PDF format so that users could see in the field
- No number limit of PDF files as PDF files are saved in external memories
- This function is available only in iXP2/iXP series HMIs, not in XP series HMIs

Scheduler

- Scheduler assigns an operation to be executed on a set time.
- Available functions include Bit ON/OFF, setting Word values and a script operation. Each scheduler can assign up to 8 operations.
- Up to 32 schedulers can be set.



Recipe

- After the data to be written on PLC are created, the data values created on a PLC device continuously connected to a specific device can be written.
- It can read a lot of device values from the PLC continuously connected to a specific device.
- Basic recipe can register up to 10000 Word/DWord devices and 255 table blocks.
- Recipe data are saved in a non-volatile memory of XGT Panel. Thus, when the power is out, the data saved at the last minute are kept.
- Recipe data can be registered and edited using a XGT Panel or an EXCEL program.

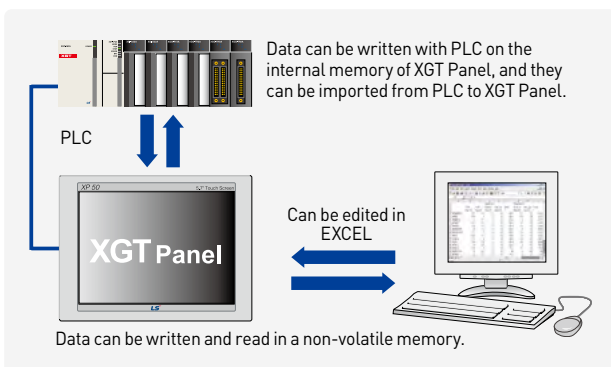

Script

Providing a flexible script language

- It is difficult to perform drawing using only the provided object functions, and it can be supplemented using a script.
- A structured language similar to the C language is used for user's convenience.
- The script using complicated arithmetic operations and various functions is executed to greatly reduce the load upon external controllers.
- A validity check of the grammar on the created scripts is available.

Various uses of scripts

- A wide range of scripts including global scripts, screen scripts and object scripts can be used depending on the usage.
- A global script operates according to ON/OFF of the device assigned, regardless of the screen operation, and a special device can be used for scripts in a regular basis.
- An object script can perform operational management of the object devices.
- A script can run when a screen opens or closes.

Mounting Flexibility

- All iXP2/iXP series models and eXP20 can be mounted in portrait or landscape mode as per user's needs and preference.
- Configurable in project property menu.



Operation Logging

- TTA models of XP Series and all iXP2/iXP models can save logs of your operation in touch screen.
- Use saved logs to check system's operation or errors.

Link with Controllers

Convenient Simulator

Offline simulation

- Without XGT Panel, the drawing data can be directly viewed from PC.
- Devices can be monitored using a PC, and values can be directly input to check operations.
- A simulator is used to check the operations just like the XGT Panel. Before transmitting the drawing data to HMI, data errors and abnormal operations can be checked.



Able to Link with PLC Simulator

- Controlling and monitoring testing in PC linking XP-Builder (XP-Simulator) and PLC simulator
- Linking with LS ELECTRIC PLC simulator and XG5000 simulator
- Linking with SIEMENS PLC simulator and S7-PLCSIM (S7-PLCSIM v5.4 or above)
- Linking with Rockwell Automation PLC simulator and RSLogix Emulate 5000 Controller (v21.00.00 or above)
- Linking with Mitsubishi PLC simulator and GX Simulator (GX Simulator v7.30 or above)

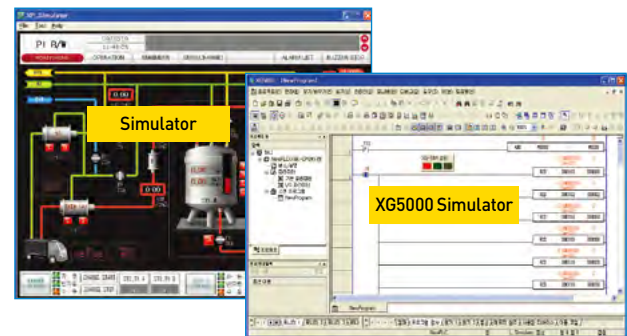

Path-through(XP-VSP)

When XGT Panel is connected to PLC with serial, PLC ladder program can be modified using the internal Ethernet.

- Users no longer have to change the cable for PLC program modification, or to go to the PLC for changes.
- A program can be modified even when a control panel is far away.

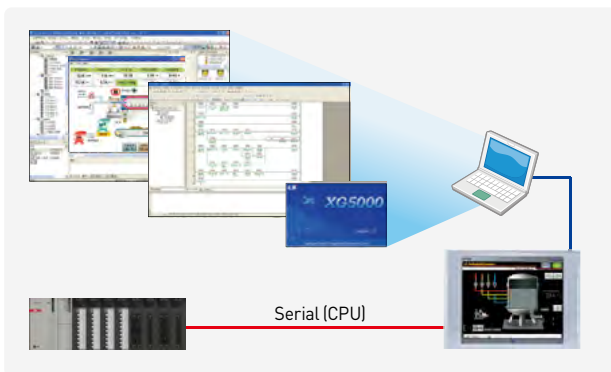

Note) XP-VSP user manual reference

Manufacturers	Supported Drives
LS ELECTRIC	ALL LS ELECTRIC PLC CPU XGI/K Series Link(Only Remote-1 Connection)
Omron Corporation	CS/CJ Host Link Serial
YASKAWA	MEMOBUS RTU Master

Using XGT PLC for batch-registration of devices (tag function)

The variable names used in the PLC program that is created using XG5000 are automatically registered in XP-Builder, so that they can be used in drawings.

- [Save as a Variable/Description File] of XG5000 is used to first save the variable names used as CSV files.
- Using [Import XG5000 Symbols] from the [Tag] item of XP-Builder, an automatic registration via tags is possible (Array variables supported).
- Without changing the memory address, the variables used in the PLC program can be used.

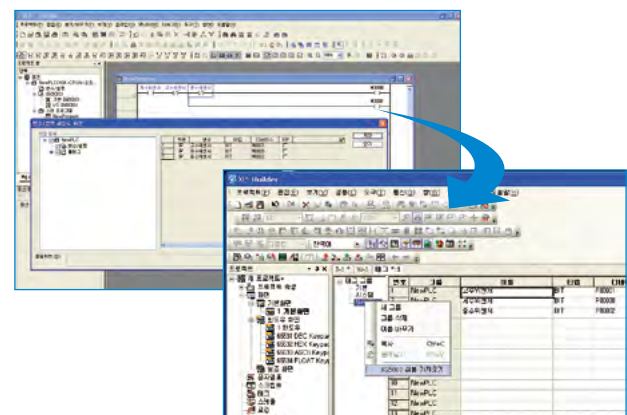

Communication Options

Fieldbus option provided

Various Fieldbus communications using the XGT Panel options

(RAPIEnet, Profibus-DP and CANopen Slave offered)

RAPIEnet(XPO-EIMT) twisted-pair ring system diagram

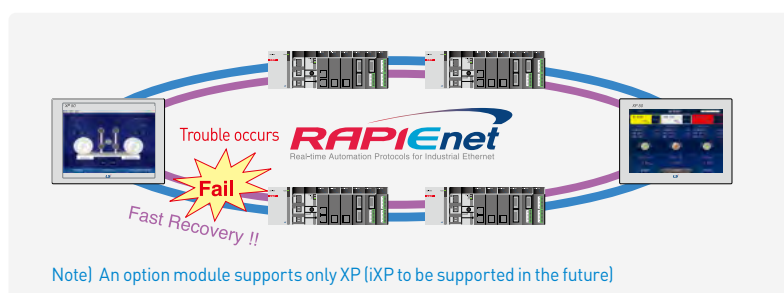

XP-Server Function

The data required from the production site's XGT Panel can be directly collected or saved in a PC.

It has several roles including a mutual data exchange between several XGT Panels, or sending an E-mail or connecting to a Database.

- It connects to the Database via PC to save, inquire and manage the XGT Panel data.
- When a trigger condition is generated, users will be informed via data E-mail of PC.
- When a trigger condition is generated, it imports or writes the screen capture, logging, alarm and recipe data of a specific XGT Panel.
- It is possible to collect various information including production outputs and causes of errors and failures from the XGT Panel to the DB server

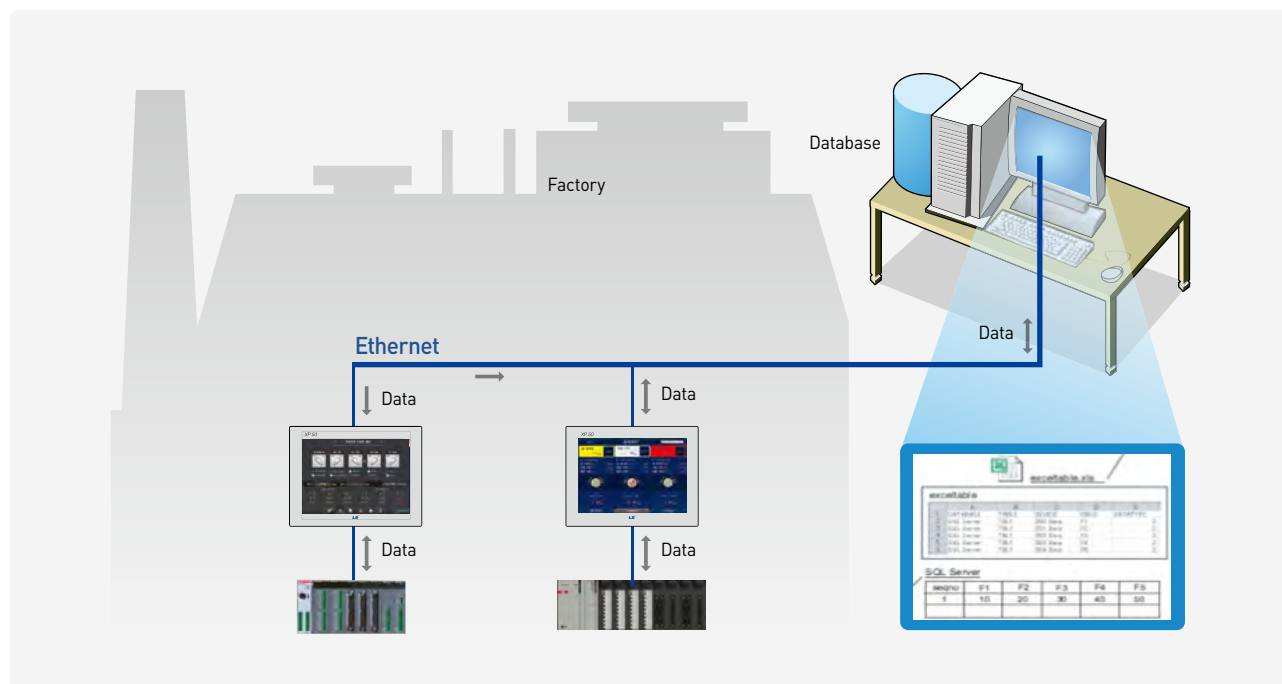

External Monitoring Function

※ Only the Ethernet-support models can use the function.

XP-Remote

- An XGT Panel screen can be monitored and controlled remotely with a PC.
- Up to 4 PCs can remote-access to a single XGT Panel. (Only one PC can access XP-VNC.)
- Remote PC control of XGT Panels can be authorized or restricted (When not authorized, it is impossible to control with the Remote PC).
- There is a synchronization mode and a non-synchronization mode, which allows users to monitor the XGT Panel and the Remote PC screen under the same or different conditions.

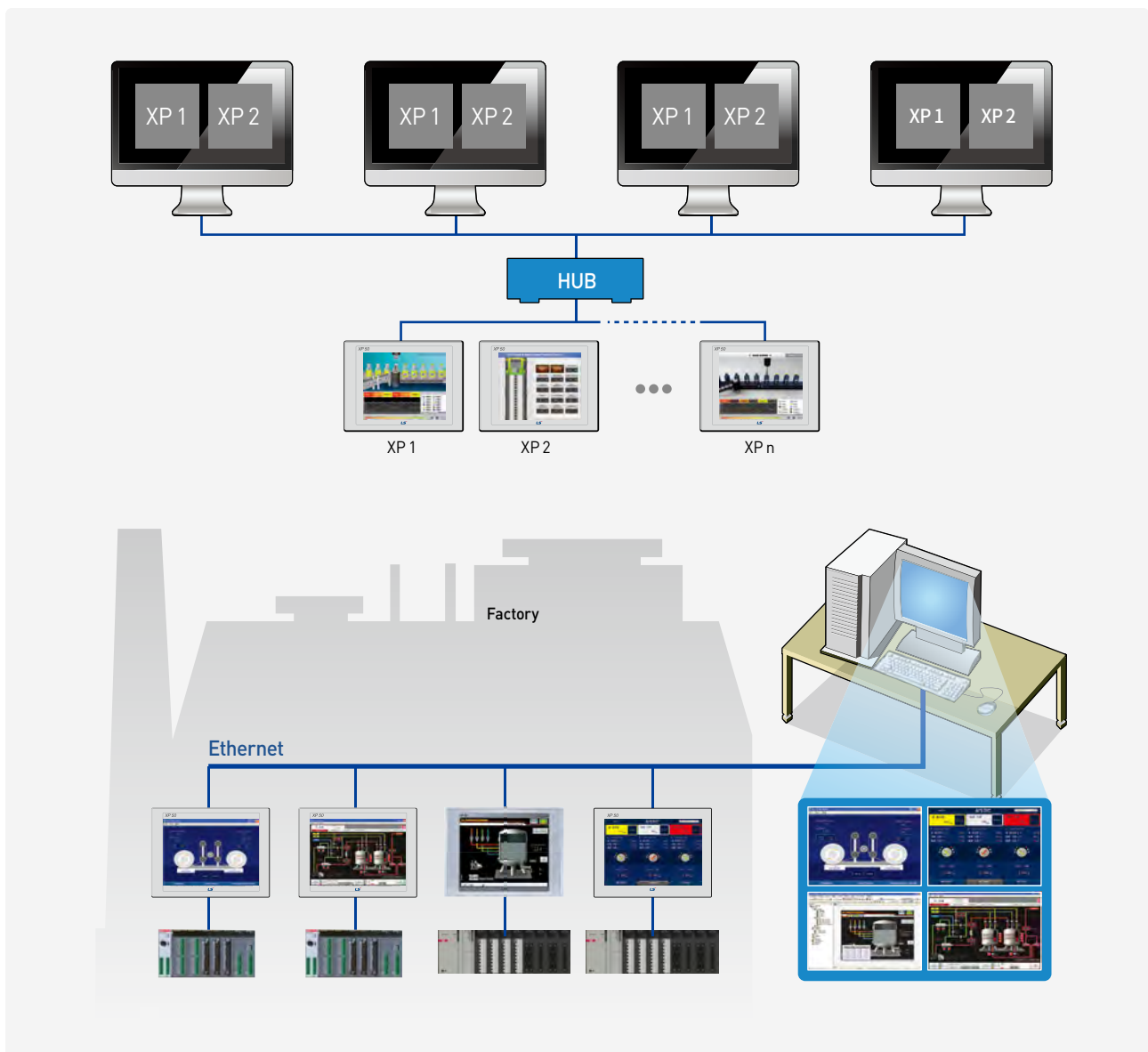

Web Server

- The screen currently viewed on a XGT Panel can be viewed on a web browser via Internet.
- It is accessible in any place where Internet is connected.
- It can be connected to multiple Internet Explorers. (Impossible to access the XP screen at the same time)
- It is possible to upload the logging and alarm backup files as csv files in the XGT Panel.
- It is possible to restrict access of specific users or groups.

※ The functions described above are available when a Web Server Program is installed to the XGT Panel using XP-Manager.

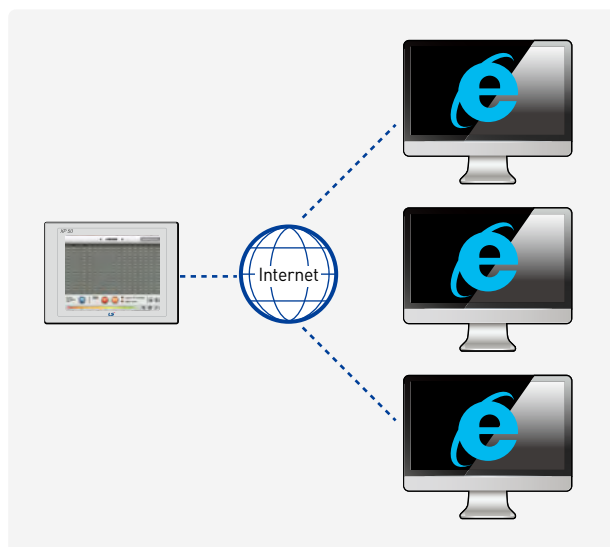

XP-VNC

- The screen currently shown in the XGT Panel can be viewed from the user's PC.
- Several XGT Panels can be monitored and controlled with one PC.
- After inserting the IP of XGT Panel to be accessed from XP-VNC (S/W for PC), the current screen of the XGT Panel can be monitored and controlled.
- It is possible to restrict PC control when the XGT Panel is under operation on site (VNC interlock device provided).

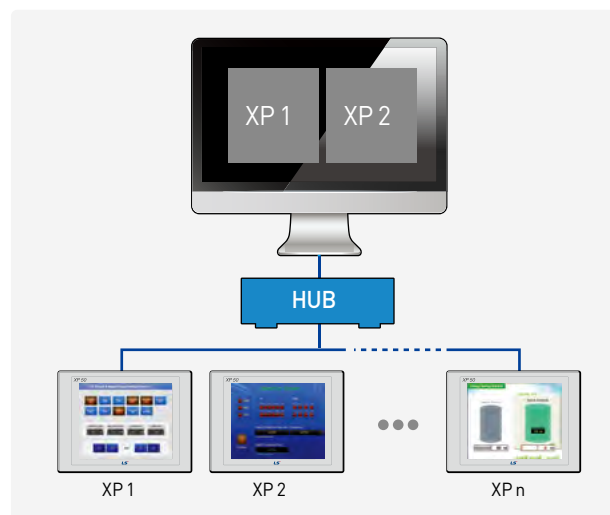

VNC Client

- All iXP2/iXP series models can be shown screen of another PC or HMI in your HMI.
 - To view another PC's screen, install universal VNC server (Ultra VNC, Real VNC and so on).
 - To view another HMI's screen, download VNC server to your HMI using XP-Manager.
- Add "VNC Viewer" object in your HMI project.

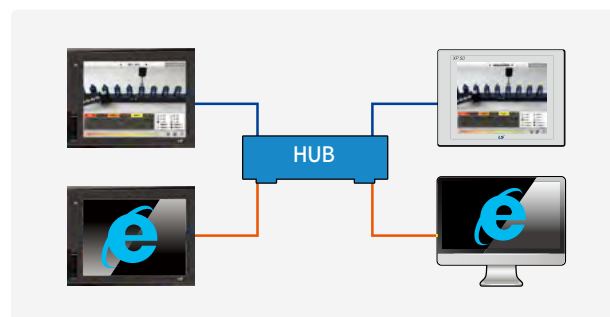



Feature

System Block Diagram

1 : 1 Serial/Ethernet Communication

One controller to one XGT Panel

※ In case of the 1:1 Ethernet communication, a cross cable should be used.



N : 1 Serial Communication

One controller to multiple XGT Panels (serial)

※ Up to 16 XGT Panels can be connected, but the speed for screen refreshing varies according to the number of panels.

※ Connection available only to specific controllers (limited to PLCs)



Simultaneous Connection with Multiple Controllers

4 kinds of controllers to one XGT Panel

※ Without the RS-422/485 and RS-232C, up to 4 controllers can be connected using only Ethernet.

※ When it comes to iXP2/iXP, up to 16 controllers can be connected.

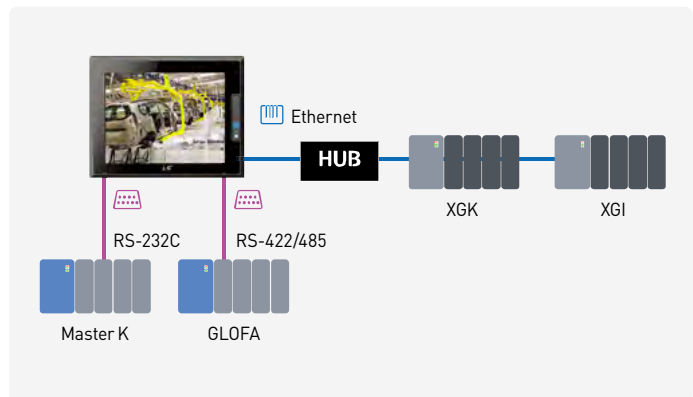

1 : N Serial Communication (Multi Drop)

Multiple controllers to one XGT Panel

※ When 1:N communication is applied, the same types of controllers should be used.

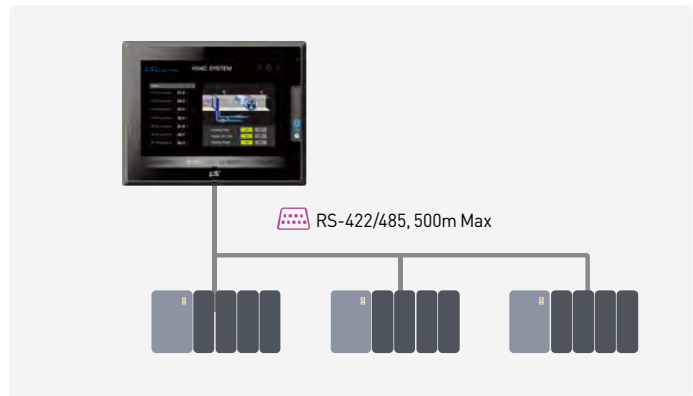

N:1 Ethernet Communication

One controller to multiple XGT Panels (Ethernet)

※ According to the controller type, the number of XGT Panels connected may vary.

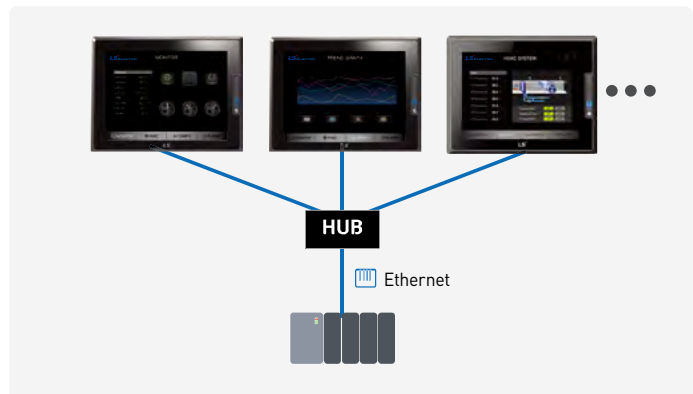

N:M Ethernet Communication

Multiple controllers to multiple XGT Panels

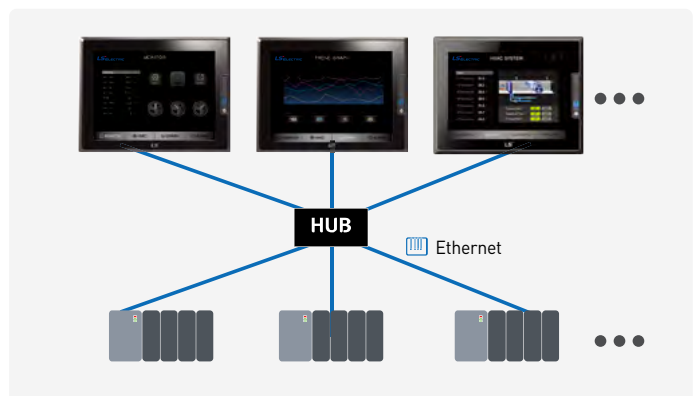

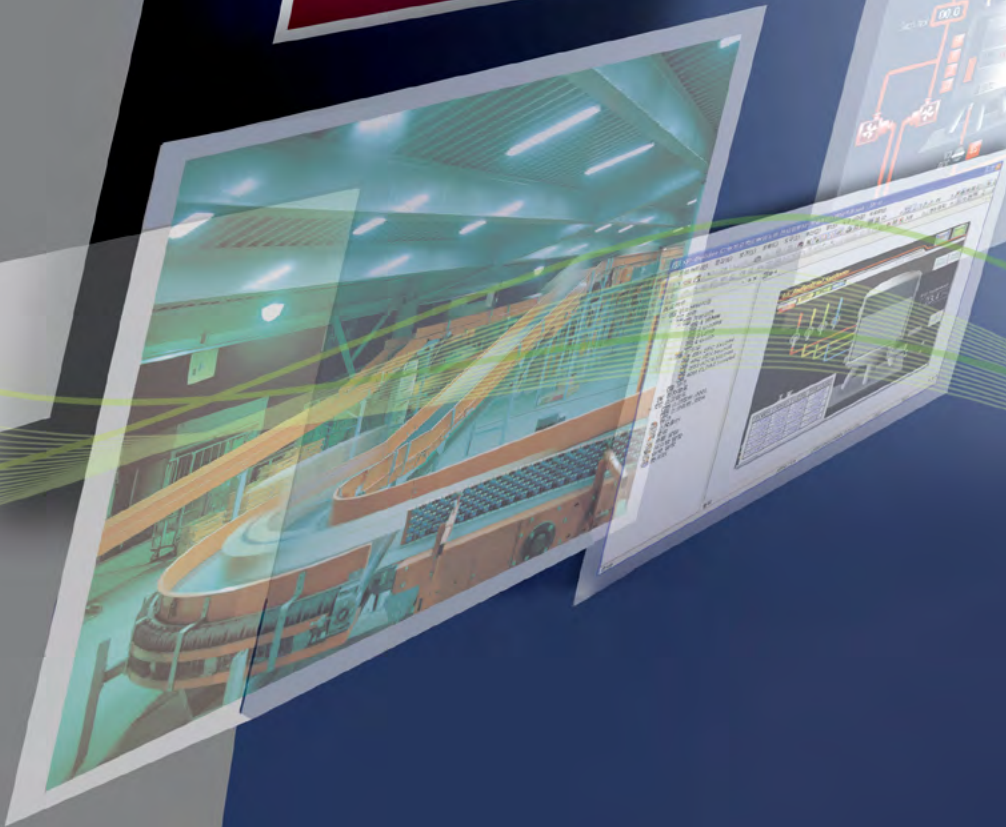

Our Solution

We are leaping as a global leader beyond the top enterprise in Korea in the field of automation solutions.

The LS ELECTRIC HMI solutions incorporate the core H/W and S/W technologies and services, which are optimized for client's environments at various industrial sites, ranging from unit machines to massive process control.

iXP2 Series

- Aluminum body frame, responsive touch screen.
- Easy-to-use Multi-touch, gesture, dual screen, portrait mode.
- Multi connected with 1Gbits 2ch. Ethernet between PC to PLC.
- Various interfaces : USB host /device, SD card, HDMI.
- High resolution : 1024 X 768
- IP66, UL type 4x, NEMA 4x standards
- Explosion proof. IECEx, ATEX, KCs



[Unit: mm]

Dimensions

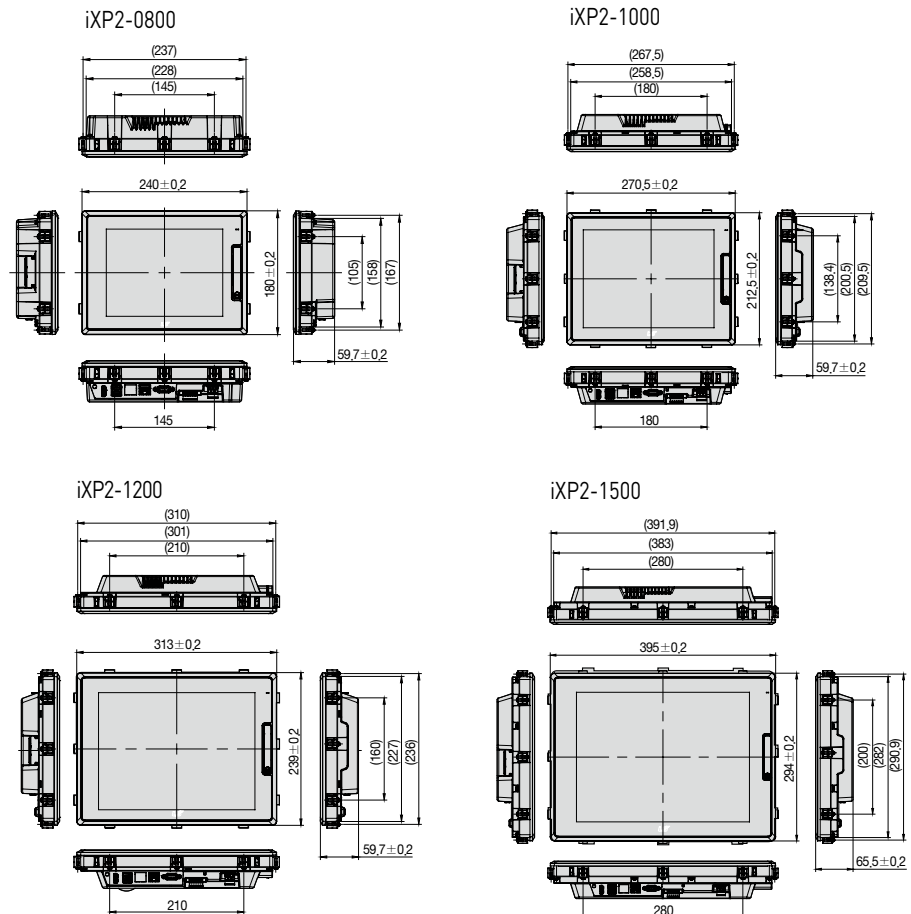

General Information

Item	Description	Standard				
Ambient temperature	0°C~+50°C					
Storage temperature	-20°C~+60°C					
Ambient humidity	10~85%RH, without dew condensation					
Storage humidity	10~85%RH, without dew condensation					
Vibration resistance	Occasional Vibration		Counts	10 times each direction (X, Y and Z)	IEC 61131-2	
	Frequency	Acceleration				Amplitude
	5≤f<9Hz	-				3.5mm
	9≤f≤150Hz	9.8m/s ²				-
	Continuous Vibration					
	Frequency	Acceleration				Amplitude
5≤f<9Hz	-	1.75mm				
9≤f≤150Hz	4.9m/s ²	-				
Shock resistance	Maximum shock acceleration: 147m/s ² (15g) Authorization time: 11ms Pulse waveform: Half-sine wave pulse (3 times each of X, Y and Z)	IEC 61131-2				
Noise resistance	Square wave impulse noise	DC: ±1,200V AC: ±1,600V	LS ELECTRIC Standards			
	Electrostatic discharge	±4kV (Contact discharge)	IEC 61131-2, IEC 61000-4-2			
	Radiated electromagnetic field noise	80 ~ 100MHz, 10V/m	IEC 61131-2, IEC 61000-4-3			
	Fast transient/Burst noise	Power module: 2.4 kV, Communication interface: 1.2kV	IEC 61131-2, IEC 61000-4-4			
Operating ambience	Free from corrosive gas and excessive dust					
Altitude	2,000m (6,562ft) or below					
Pollution degree	2 or under					
Cooling method	Natural air-cooling					

Specifications

Item	iXP2-0800A/D	iXP2-1000A/D	iXP2-1200A/D	iXP2-1500A/D
Display type	TFT color LCD			
Screen size	8.4"	10.4"	12.1"	15"
Display resolution	800X600	1,024X768		
Color indication	24-bit color (16.7M colors)			
Backlight	LED method, automatic On / Off support			
Backlight lifetime	40,000 hour			
Touch panel	Capacitive touch			
Audio output	Magnetic buzzer (85dB)			
Processor	1GHz, Dual core			
Memory	Flash	1GB		
	Operating RAM	1GB		
	Backup RAM	1 Mbyte		
Backup data	Date / Time data, Logging / Alarm / Recipe data, Non-volatile devices			
Battery	CR2032(3.0V/210mAh, About 3years/25°C)			
Video output	1 X HDMI			
Ethernet	1 X 10Base-T / 100Base-TX, 1 X 10Base-T / 100Base-TX / 1000Base-T			
USB host	3 X USB 2.0 (Front X1, Rear X2)			
USB device	1 X USB 2.0 (Send / Receive front, PC and project data etc.)			
RS-232C	1 X RS-232C (DSUB 9 / Male type)			
RS-422/485	1 X RS-422/485 (Terminal block)			
Multi-language	Can display 12 languages simultaneously			
Animation	GIF format support			
Recipe	Support			
Data logging	Support			
Script launcher	Support			
Standard certification	CE, KC, UL, IECEx, ATEX, KCs			
Protection standard	IP66, Conform to the UL type 4x, NEMA 4x standard			
Explosion proof	Ex nA IIC T5 Gc, Ex tc IIC T100°C Dc IP64			
Dimensions (mm)	240X180X60	271X212X60	313X239X60	395X294X66
Panel cut (mm)	228.5X158.5	259.0X201.0	301.5X227.5	383.5X282.5
Power	iXP2-xxxxA: AC100 / 240V, iXP2-xxxxD: DC24V			
Power consumption (W)	25	25	30	30
Weight (Kg)	1.87	2.35	3.0	4.6

iXP Series

High-resolution and performance

- 1GHz high-performing CPU & quick screen refreshing speed
- 16,777,216. TFT color (24bit) support & high-luminance/resolution LCD
- Mass internal memory (User memory: 128MB, Data backup: 1MB)

User-oriented simple environment

- Various storage interfaces (USB/SD)
- Movement detection (presence sensor) system



[Unit: mm]

Dimensions

iXP50-TTA

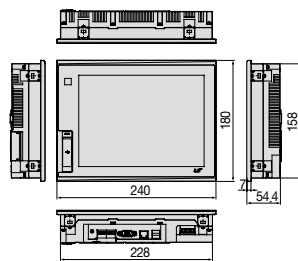

iXP70-TTA

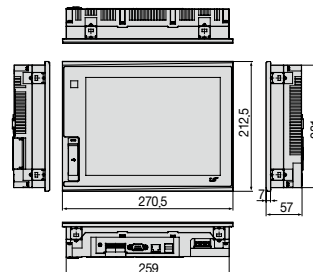

iXP80-TTA

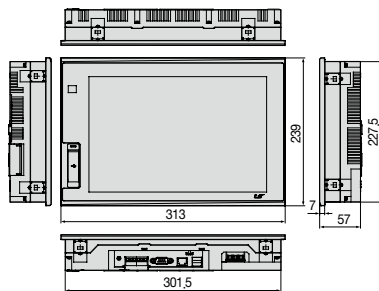

iXP90-TTA

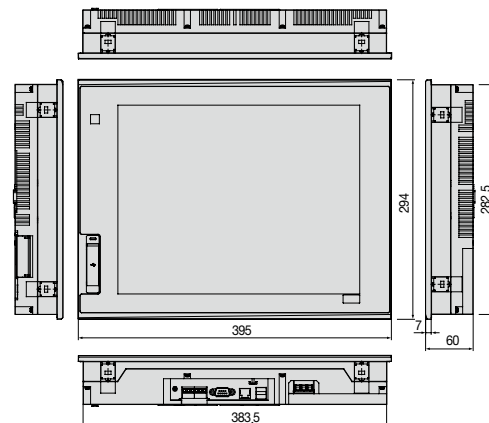

General Information

Item	Description	Standard				
Ambient Temperature	0°C~+50°C					
Storage Temperature	-20°C~+60°C					
Ambient Humidity	10~85%RH, without dew condensation					
Storage Humidity	10~85%RH, without dew condensation					
Vibration resistance	Occasional vibration		Counts	10 times each direction (X, Y and Z)	IEC 61131-2	
	Frequency	Acceleration				Amplitude
	5≤f<9Hz	-				3.5mm
	9≤f≤150Hz	9.8m/s ²				-
	Continuous vibration					
	Frequency	Acceleration				Amplitude
5≤f<9Hz	-	1.75mm				
9≤f≤150Hz	4.9m/s ²	-				
Shock resistance	Maximum shock acceleration: 147m/s ² (15g) * Authorization time: 11ms * Pulse waveform: Half-sine wave (3 times each of X, Y and Z) *		IEC 61131-2			
Vibration resistance	Square wave impulse noise	DC: ±1,200V AC: ±1,800V		LS ELECTRIC Standards		
	Electrostatic discharge	±4kV (Contact discharge)		IEC 61131-2, IEC 61000-4-2		
	Radiated electromagnetic field noise	80 ~ 100MHz, 10V/m		IEC 61131-2, IEC 61000-4-3		
	Fast transient/Burst noise	Power Module: 2 kV, Communication Interface: 1kV		IEC 61131-2, IEC 61000-4-4		
Operating ambience	Free from corrosive gas and excessive dust					
Altitude	2,000m (6,562ft) or below					
Pollution degree	2 or under					
Cooling method	Natural air-cooling					

Specifications

Item	iXP50-TTA/DC	iXP70-TTA/DC iXP70-TTA/AC	iXP80-TTA/DC iXP80-TTA/AC	iXP90-TTA/DC iXP90-TTA/AC
Display type	TFT color LCD			
Screen size	21.3cm (8.4")	26.4cm (10.4")	30.7cm (12.1")	38.1cm (15")
Display Resolution	800X600 pixel(SVGA)	800X600 pixel(SVGA)	800X600 pixel(SVGA)	1,024X768 pixel(SVGA)
Color indication	16-bit and 24-bit Color (default: 16-bit Color)			
Indication degree	Left/Right: 80 deg. Up: 80 deg. Down: 60 deg.		Left/Right: 80 deg. Up: 60 deg. Down: 80 deg.	
Backlight	LED Type			
Backlight duration	70,000 hours	60,000 hours		
Brightness	500 cd/m ²	700 cd/m ²	550 cd/m ²	800 cd/m ²
Touch panel	4-Line type, analog			
Sound Output	Magnetic buzzer (85dB)			
Process	ARM Cortex-A8 Core (32bit RISC), 1GHz			
Memory	Flash	512MB(display 128MB)	1GB(display 128MB)	
	Operating RAM	256MB	512MB	
	Backup RAM	1MB		
Backup data	Date/Hour data, Logging/Alarm/Recipe data and nonvolatile device			
Battery duration	Approx. 3 years (Operating ambient temperature of 25°C)			
Ethernet	1 channel, 10/100BASE-TX			
USB Host	3 channels, USB 2.0 host (mouse, keyboard, printer* and USB memory driver is available) 1 channel, USB 2.0 slave (for download and upload project file)			
RS-232C	1 channel			
RS-422/485	1 channel, RS-422/485 mode			
SD Card	1 Slot (SDHC)			
Human sensor	-	Detection range: side 1-1.5m, front 40-50cm Angle: high/low 100°, left/right 140° (detecting 5-20 micron infrared light)		
Audio output	LINE-OUT 1 channel			
Expansion module	For communication and I/O option module (available later)			
VM module	-	4 channels video input (available later)		
Multi-language	Up to 12 language simultaneously			
Animation	GIF format is available			
Recipe	available			
Data logging	available			
Script executor	available			
Certifications	CE, UL(cUL), KC			
Protection standard	IP65			
Dimension (mm)	240.5X180.0X54.4	270.5X212.5X60.0	313.0X239.0X56.0	395.0X294.0X60.0
Panel cut (mm)	228.5X158.5	259.0X201.0	301.5X227.5	383.5X282.5
Rated voltage	DC24V		DC12/24V(AC 100-240V)	
Power consumption (W)	30.8	42.3	42.3	42.3
Weight(Kg)	1.9	2.2	2.4	3.9

*SEWOO printer only

eXP2 Series

Fully compatible with eXP

- Panel cut, interface, design, and drawing file are 100% compatible.

Superior Performance

- ARM Cortex A8 800MHz, eMMC 4G, DDR3

Enhanced product reliability

- LCD Backlight lifespan extended
- Non Battery Type NVRAM

Variety of interfaces and functions

- Various communication drivers and Micro SD I/F available



Dimensions

[Unit: mm]

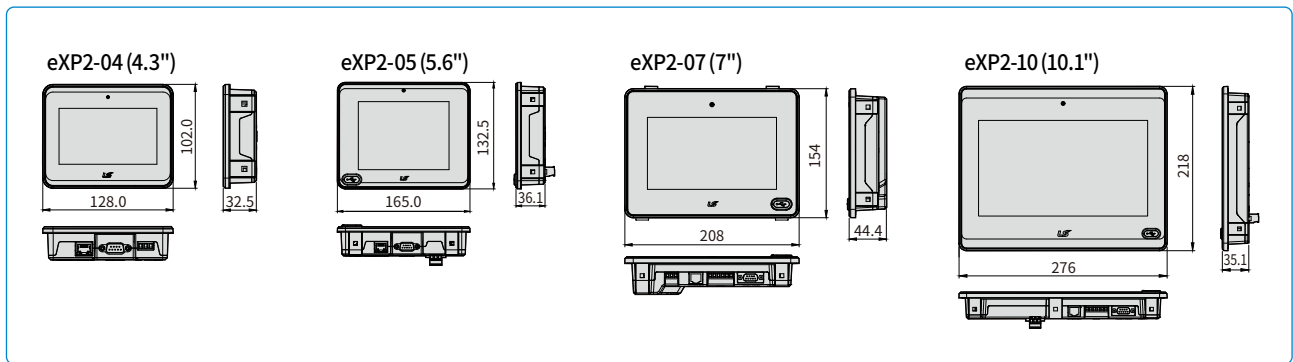

Model Naming

1	2	3	4	5	6	7
eXP	2	04	0	0	D	EX
1 Series efficient XGT Panel			5 Communication/SD Memory			
2 Generation 2nd Generation			0 Standard Model: RS-232C/RS-485/RS-422/Ethernet			
3 LCD Size			1 Advanced Model: RS-232C/RS-485/RS-422/Ethernet/Micro SD ^{*1)}			
04	10.9cm (4.3")		2 Basic Model: RS-232C/RS-485/RS-422 ^{*2)}			
05	14.2cm (5.6")		6 Power			
07	17.8cm (7")		D DC24V			
10	25.5cm (10.1")		7 Certifications			
4 OS Type			EX IP66, UL Type 4X			
0	WinCE 7.0 Core					
1	WinCE 7.0 Pro					

*1) Advanced Model: 07/10 model only

*2) Basic Model: 05/07 model only

Specifications

Item	eXP2-04□*0D	eXP2-05□*0D	eXP2-05□*2D	eXP2-07□*0D	eXP2-07□*1D	eXP2-07□*2D	eXP2-10□*0D	eXP2-10□*1D	
Display Type	TFT Color LCD								
Screen Size	10.9cm (4.3")	14.2cm (5.6")		17.8cm (7")		25.9cm (10.1")			
Display Resolution	480 x 272	640 x 480		800 x 480		1024 x 600			
Color Indication	24Bit Color (16.7M)	18Bit Color (262,144)		24Bit Color (16.7M)		24Bit Color (16.7M)			
Indication Degree	Left/Right: 60 deg. Upper: 40 deg. Lower: 50 deg	Left/Right: 60 deg. Upper: 40 deg. Lower: 60 deg.		Left/Right: 70 deg. Upper: 50 deg. Lower: 70 deg.		Left/Right: 70 deg. Upper: 50 deg. Lower: 70 deg.			
Backlight	LED Type (Supports Backlight Auto-off Function)								
Backlight Duration	50,000 Hours	20,000 Hours		50,000 Hours		30,000 Hours			
Touch Panel	4-Wire Resistive, Analog								
Audio Output	Magnetic Buzzer (85dB)								
Process	800MHz	800MHz		800MHz		800MHz			
Memory	Drawing Memory	64MB	64MB		64MB		64MB		
	Operating RAM	512MB	512MB		512MB		512MB		
	Operating RAM	128KB	128KB		128KB		128KB		
Backup Data	Date/Hour Data, Logging/Alarm/Recipe Data and Nonvolatile Device								
Battery Life	Approx. 3 years (Operating Ambient Temperature of 50°C)								
Ethernet	1 Channel, IEEE802.1a, 10Base-T/100Base-TX	-		1 Channel, IEEE802.1a, 10Base-T/100Base-TX		-		1 Channel, IEEE802.1a, 10Base-T/100Base-TX	
USB Host	1 Channel, USB 2.0 Host (Mouse, keyboard, printer, USB flash drive, etc.)								
USB Device	-	1 Channel, USB 2.0 Device (for Download and Upload Project)					1 Channel, USB 2.0 Device (for Download and Upload Project File)		
MicroSD Card	-	-		-	1 Channel SDHC Class10	-		1 Channel SDHC Class10	
RS-485, RS-232C	1 Channel, RS-232C (DSUB 9/Male Type)			2 Channels, RS-485, RS-232C (DSUB 9/Male Type)					
RS-422/485	1 Channel, RS-422/485 (DSUB 9/Male Type)			1 Channel, RS-422/485 Mode (Terminal Type)					
Multi-language	Up to 12 Language Simultaneously								
Animation	GIF Format is Available								
Recipe	Available								
Data Logging	Available								
Script Executor	Available								
Certifications	CE, UL(cUL), UL Type 4X, KC		CE, UL(cUL), KC	CE, UL(cUL), UL Type 4X, KC		CE, UL(cUL), KC		CE, UL(cUL), UL Type 4X, KC	
Protection Standard	IP65 <small>Note 1)</small>		IP65 <small>Note 1)</small>		IP65 <small>Note 1)</small>		IP65 <small>Note 1)</small>		
Dimension (mm)	128 x 102 x 32.5	165 x 132.5 x 36.1		208 x 154 x 44.4		276 x 218 x 35.1			
Panel Cut (mm)	119 x 93	156 x 123.5		192 x 138		260 x 202			
Rated Voltage	DC24V		DC24V		DC24V		DC24V		
Power Consumption (W)	4	5.5	5.5	6		6			
Weight (kg)	0.27	0.43	0.43	0.59	0.59	0.58	1.0	1.0	

□*0 (WinCE 7.0 Core), 1 (WinCE 7.0 Pro)

Note 1): IP66 for UL Type 4X models.

eXP Series

- TFT LCD-applied wide type
- LED Backlight adopted for enhanced contrast ratio and low-power
- PLC Ladder monitoring function: Only XGK/XBC supports*
- Web Server* / Data Server* / Path-Through Function*
- Remote Viewer Function*
- Screen editor : XP-Builder

* Functions that support only the TTA model



[Unit: mm]

Dimensions

eXP20-TTA

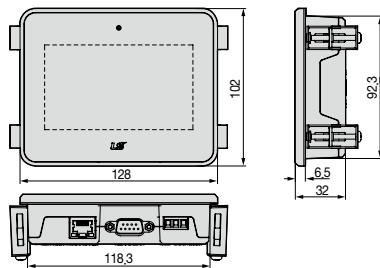

eXP30-TTA

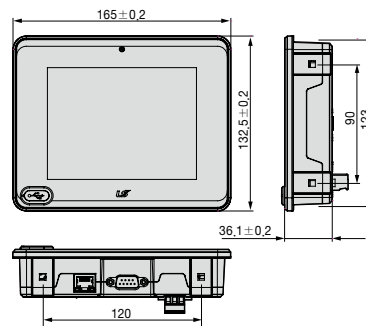

eXP40-TTA

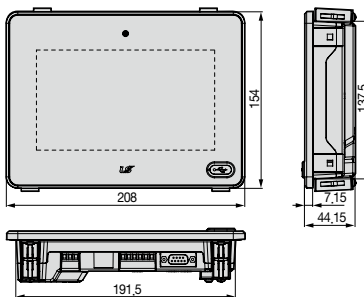

eXP60-TTA

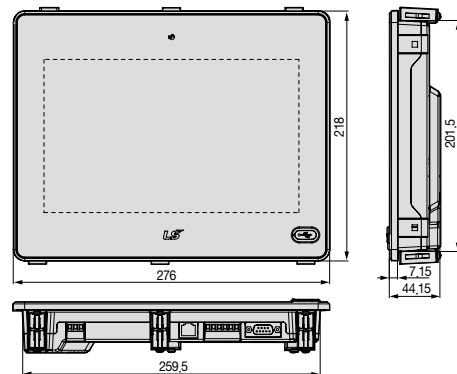

General Information

Item	Description	Standard				
Ambient temperature	0°C~+50°C					
Storage temperature	-20°C~+60°C					
Ambient humidity	10~85%RH, without dew condensation					
Storage humidity	10~85%RH, without dew condensation					
Vibration resistance	Occasional Vibration		Counts	10 times each direction (X, Y and Z)	IEC 61131-2	
	Frequency	Acceleration				Amplitude
	5≤f<9Hz	-				3.5mm
	9≤f≤150Hz	9.8m/s ²				-
	Continuous Vibration					
	Frequency	Acceleration				Amplitude
5≤f<9Hz	-	1.75mm				
9≤f≤150Hz	4.9m/s ²	-				
Shock resistance	Maximum shock acceleration: 147m/s ² (15g) Authorization time: 11ms Pulse waveform: Half-sine wave pulse (3 times each of X,Y and Z)			IEC 61131-2		
Noise resistance	Square wave impulse noise	DC: ±1,200V		LS ELECTRIC Standards		
	Electrostatic discharge	±4kV (Contact discharge)		IEC 61131-2, IEC 61000-4-2		
	Radiated electromagnetic field noise	80 ~ 100MHz, 10V/m		IEC 61131-2, IEC 61000-4-3		
	Fast transient/Burst noise	Power module: 2.4 kV, Communication interface: 1.2kV		IEC 61131-2, IEC 61000-4-4		
Operating ambience	Free from corrosive gas and excessive dust					
Altitude	2,000m (6,562ft) or below					
Pollution degree	2 or under					
Cooling method	Natural air-cooling					

Specifications

Item	eXP20-TTA/DC,CERTI	eXP20-TTA/DC	eXP30-TTA(BI)/DC	eXP30-TTE/DC	eXP40-TTE/DC	eXP40-TTA(BI)/DC	eXP60-TTA(BI)/DC
Display type	TFT color LCD						
Screen size	10.9cm (4.3inch)		10.9cm (4.3inch)		10.9cm (4.3inch)		25.9cm(10.2inch)
Display Resolution	480 x 272 pixel		640 x 480 pixel		800 x 600 pixel(WVGA)		
Color indication	24-bit Color(16.7M)		16-bit Color(65,536 Color)		24-bit Color(65,535 Color)		16-bit Color(65,536)
Indication degree	Left/Right:60 deg. Upper:40 deg. Lower:60 deg.						Left/Right:55 deg. Upper:35 deg. Lower:55 deg.
Backlight	LED Type (Supports backlight auto-off function)						
Backlight duration	30,000 hours				20,000 hours		
Touch panel	4-Wire Resistive, analog						
Audio output	Magnetic buzzer (85dB)						
Process	i.MX283(454MHz)						
Memory	Flash	128MB(Screen 64MB)					
	Operation RAM	128MB					
	Backup RAM	128KB					
Backup data	Date/Hour data, Logging/Alarm/Recipe data and nonvolatile device						
Battery duration	Approx. 3 years (Operating ambient temperature of 50°C)						
RTC	Time error Approx. 3 sec/1day(Operating ambient temperature of 25°C)						
Ethernet	1 channel, IEEE802.1a, 10Base-T/100Base-TX			-		1 channel, IEEE802.1a, 10Base-T/100Base-TX	
USB Host	1 channel, USB 2.0 Host (mouse, keyboard, printer and USB memory driver is available)						
USB Device	- 1 channel, USB 2.0 Device (for download and upload project)						
RS-485, RS-232C	1channel, RS-232C (DSUB 9/Male Type)			2channels, RS-485, RS-232C (DSUB 9/Male Type)			
RS-422/485	1channel, RS-422/485 (DSUB 9/Male Type)			1channel, RS-422/485 mode (Terminal Type)			
Multi-language	Up to 12 language simultaneously						
Animation	GIF format is available						
Recipe	available						
Data logging	available						
Script executor	available						
Certifications	CE, UL, KC, UL Type4X (Separate product, CERTI)						
Protection standard	IP66						
Dimension (mm)	128x102x32		165.0x132.5x36.1		208.0 x 154.0 x 44.4		276.0 x 218.0 x 44.4
Panel cut (mm)	165.0 x 132.5 x 36.1		156.0 x 123.5		192.0 x 138.0		260.0 x 202.0
Rated voltage	DC24V						
Power consumption (W)	4.6W		7.2W		6.5W		10W
Weight(Kg)	0.3		0.42	0.39	0.62	0.63	1.08



List of Communication Drivers

Manufacturer	Driver name
LS ELECTRIC	GM CPU
	GM Cnet
	GM Enet
	MK CPU
	MK Cnet
	MK Enet
	XGK CPU
	XGK Cnet
	XGK Enet
	XGK CPU Enet
	XGK EtherNet/IP
	XGB CPU
	XGB Cnet
	XGB Enet
	XGB EtherNet/IP
	XGB Cnet - VCB Trip
	XGI/XGR CPU
	XGI/XGR Cnet
	XGI/XGR Enet
	XGI/XGR CPU Enet
	XGI/XGR EtherNet/IP
	XEC CPU
	XEC Cnet
	XEC Enet
	XEC EtherNet/IP
	XMC Enet
Inverter (LS INV 485)	
Inverter (MODBUS)	
User Defined Protocol	
User Defined Protocol (Slave)	
XGT Servo	
LS Mecapion	VS/VP Servo Drive
	MXQ Series
BACnet	BACnet IP Master
BYD Auto	BYD Auto dedicated
CAN in Automation	CANopen Slave
Control Techniques	CT Modbus RTU
DAEWON GSI	DAEWON GSI dedicated controller
Dasarobot	iM-SIGMA series
Delta Electronics	DVP Series
Digital Eelectronics(Pro-face)	Memory Link
Fuji Electric Systems	MICREX-SX Series SIO
	MICREX-SX Ethernet
GE Intelligent Platforms	SNP
	SNP-X
HANYOUNG NUX	Temperature Controller
HIGEN Motors	Servo
Hitachi	H Series Ethernet
	H Series Link
HYUNDAI Elevator	SKY-RAV(Ethernet)
	SKY-RAV(Link)

Manufacturer	Driver name
KDT Systems	CIMON Serial Link
	BP Series Loader
	CP Series Loader
	XP Series Loader
KEYENCE	KV-700/1000/3000/5000/5500 Serial
	KV-700/1000/3000/5000/5500 Ethernet
KOYO Electronic	DirectNet
KTURBO	Turbo Blower
Lenze Automation	Lecom A/B
Mitsubishi Electric	MELSEC A-CPU
	MELSEC A-Link
	MELSEC FX-CPU
	MELSEC FX-Ethernet
	MELSEC FX-Link
	MELSEC Q-CPU
	MELSEC QnA-Link
	MELSEC QnA-Ethernet
	MELSEC QnU CPU Ethernet
	MELSEC iQ-R Ethernet
	MELSEC iQ-F Ethernet
	MELSEC iQ-F Link
	MELSERVO-J2
MELSERVO-J3	
OMRON	CS/CJ Series Ethernet
	CS/CJ Host Link
	C Series Host Link
	CS1 EthernNet/IP
	CJ2 EthernNet/IP
Panasonic	FP Series
	MINAS Servo
Parker	Hi-Drive
PROFIBUS International	PROFIBUS DP Slave
Rockwell Automation	Compact/ControlLogix EtherNet/IP
	MicroLogix EtherNet/IP
	SLC500 Series DF1
	Compact/ControlLogix DF1
	MicroLogix DF1
	Micro800 Series (DF1)
RS Automation	EtherNet/IP Micro800 Series
	N/NX-CCU
Schneider Electric	NX-CCU+
	MODBUS RTU Master
	MODBUS RTU Slave
	MODBUS TCP Master
	MODBUS TCP Slave
	MODBUS ASCII Master
	MODBUS ASCII Slave
SEW EURODRIVE	MOVDRIVE Serial
Siemens AG	S7 3964(R)/RK512
	S7 MPI(Adapter)
	S7 PPI

Manufacturer	Driver name
Siemens AG	S7 3964(R)/RK512
	S7 MPI(Adapter)
	S7 PPI
	LOGO Ethernet
	S7 1200/1500 Ethernet
	S7 300/400 Ethernet
Sprint Electric	DC Motor Drive Ethernet
YASKAWA Electric	MEMOBUS RTU Master
	MP Series Ethernet (Extension)
	YASKAWA: High-Speed Ethernet Server
YOKOKAWA Electric	FA-M3 Series
	FA-M3 Series-Ethernet
Beckhoff	ADS Ethernet
TSSI	VERID+ FingerPrint Reader
FATEC Automation Corporation	FATEK: FB Series Serial
	FATEK: FB Series Ethernet
TemcoLine	Thermometer Controller
Autonics	Thermometer Controller (TK Series)
Yudian	AIBus Protocol
RKC	CB Series Temperature Controller
	FB Series Temperature Controller
Azbil	Temperature Controller
Kolver	EDU 2AE/TOP/TA/MITO
Atras Copco.	MT Focus400
Sick AG	Sick AG: Flexi Soft
IAI	IAI: X-SEL Controller Serial
	IAI: ROBO Cylinder Controller Serial
FANUC	FANUC : Series 0i
Ingenia	Ingenia: EMCL Serial
AERZEN TURBO	AERZEN TURBO: Aerzen-Turbo 1(IG3)
	AERZEN TURBO: Aerzen-Turbo 2(IG5)
Kawasaki Heavy Industries	KAWASAKI: UNIVERSAL CONTROLLER(ETHERNET)
OPC	OPC UA Client



Safety Instructions

- For your safety, please read user's manual thoroughly before operating.
- Contact the nearest authorized service facility for examination, repair, or adjustment.
- Please contact qualified service technician when you need maintenance. Do not disassemble or repair by yourself!
- Any maintenance and inspection shall be performed by the personnel having expertise concerned.



- According to The WEEE Directive, please do not discard the device with your household waste.



www.ls-electric.com

■ **Headquarter**

LS-ro 127(Hogye-dong) Dongan-gu, Anyang-si, Gyeonggi-Do, 14119, Korea

■ **Seoul Office**

LS Yongsan Tower, 92, Hangang-daero, Yongsan-gu, Seoul, 04386, Korea
Tel: 82-2-2034-4033, 4888, 4703 Fax: 82-2-2034-4588

Southeast Asia +82-2-2034-4888 cshwang@ls-electric.com (Charles Hwang)

Europe +82-2-2034-4676 sukyong@ls-electric.com (Brian Choi)

Turkey/Israel/CIS +82-2-2034-4879 dkimc@ls-electric.com (Daniel Kim)

Oceania +82-2-2034-4394 kacho@ls-electric.com (Kendra Cho)

North/Latin America +82-2-2034-4286 hkchung@ls-electric.com (Hank Raul Chung)

Southwest Asia/Africa +82-2-2034-4467 myleed@ls-electric.com (Henry Lee)

Middle East +971-4-886-5360 khchoi1@ls-electric.com (Lambert Choi)

■ **Overseas Subsidiaries**

• **LS ELECTRIC Japan Co., Ltd. (Tokyo, Japan)**

Tel: 81-3-6268-8241 E-Mail: japan@ls-electric.com

• **LS ELECTRIC (Dalian) Co., Ltd. (Dalian, China)**

Tel: 86-411-8730-6495 E-Mail: china.dalian@lselectric.com.cn

• **LS ELECTRIC (Wuxi) Co., Ltd. (Wuxi, China)**

Tel: 86-510-6851-6666 E-Mail: china.wuxi@lselectric.com.cn

• **LS ELECTRIC Middle East FZE (Dubai, U.A.E.)**

Tel: 971-4-886-5360 E-Mail: middleeast@ls-electric.com

• **LS ELECTRIC Europe B.V. (Hoofddorp, Netherlands)**

Tel: 31-20-654-1424 E-Mail: europartner@ls-electric.com

• **LS ELECTRIC America Inc. (Chicago, USA)**

Tel: 1-800-891-2941 E-Mail: sales.us@lselectricamerica.com

• **LS ELECTRIC Turkey Co., Ltd.**

Tel: 90-212-806-1225 E-Mail: turkey@ls-electric.com

■ **Overseas Branches**

• **LS ELECTRIC Tokyo Office (Japan)**

Tel: 81-3-6268-8241 E-Mail: tokyo@ls-electric.com

• **LS ELECTRIC Beijing Office (China)**

Tel: 86-10-5095-1631 E-Mail: china.auto@lselectric.com.cn

• **LS ELECTRIC Shanghai Office (China)**

Tel: 86-21-5237-9977 E-Mail: china.auto@lselectric.com.cn

• **LS ELECTRIC Guangzhou Office (China)**

Tel: 86-20-3818-2883 E-Mail: china.auto@lselectric.com.cn

• **LS ELECTRIC Chengdu Office (China)**

Tel: 86-28-8670-3201 E-Mail: china.auto@lselectric.com.cn

• **LS ELECTRIC Qingdao Office (China)**

Tel: 86-532-8501-2065 E-Mail: china.auto@lselectric.com.cn

• **LS ELECTRIC Nanjing Office (China)**

Tel: 86-25-8467-0005 E-Mail: china.auto@lselectric.com.cn

• **LS ELECTRIC Bangkok Office (Thailand)**

Tel: 66-90-950-9683 E-Mail: thailand@ls-electric.com

• **LS ELECTRIC Jakarta Office (Indonesia)**

Tel: 62-21-2933-7614 E-Mail: indonesia@ls-electric.com

• **LS ELECTRIC Moscow Office (Russia)**

Tel: 7-499-682-6130 E-Mail: info@lselectric-ru.com

• **LS ELECTRIC America Western Office (Irvine, USA)**

Tel: 1-949-333-3140 E-Mail: america@ls-electric.com